

AKMA™ Anodized Washdown Motor

Selection Guide



KOLLMORGEN

A REGAL REYNORD BRAND

Kollmorgen: Your Partner, In Motion.

Every solution comes from a real understanding of the challenges facing machine designers and users.

Innovators consistently rate Kollmorgen as one of their best motion systems manufacturing partners. Whether you are looking for classic servo motors, direct-drive servo motors, stepper motors, drives & amplifiers, gearing, actuation, or multi-axis motion controllers, Kollmorgen is one of the few companies in the world that actually designs and manufactures all of these products.

Our customers are leaders in many industries such as Aerospace & Defense, Printing, Packaging & Converting, Food & Beverage Processing, Medical Imaging, In Vitro Diagnostics & Laboratory Automation, Pharmaceutical Manufacturing, Material Forming and Cutting, Oil & Gas, and Robotics. Kollmorgen is also a leader in Warehouse Automation, including complete AGV systems, software, awareness and autonomy.

Our Automation Solutions can be found on Mars and in space, ships and submarines, O&G drilling and metrology, surgical robots and laser eye surgery, even inside artificial hearts. These are just a few applications that demand high-performance and high-quality while satisfying their specific needs.

Because motion matters, it's our focus: Motion can distinctly differentiate a specific machine and deliver a marketplace advantage by increasing its performance and dramatically improving Overall Equipment Effectiveness (OEE).

High-performance motion can make your customer's machine more reliable and energy-efficient, enhance accuracy and improve operator safety. Motion also represents endless possibilities for innovation.

We've always understood this potential, and thus have kept motion at our core and in our Vision, Mission & Values, relentlessly developing products that offer precise control of torque, velocity and position accuracy in machines that rely on complex motion.

Removing the Barriers of Design, Sourcing, and Time

At Kollmorgen, we know that OEM engineers can achieve a lot more when obstacles aren't in the way. So, we clear obstacles in three important ways:

Integrating Standard and Custom Products

The optimal solution is often not clear-cut. Our application expertise allows us to modify standard products or develop totally custom solutions across our whole product portfolio so that designs can take flight.

Providing Motion Solutions, Not Just Components

As companies reduce their supplier base and focus their engineering manpower on the product design, they need a total system supplier with a wide range of integrated solutions. Kollmorgen offers complete solutions as well as motion subsystems that combine programming software, engineering services and best-in-class motion components.

Global Footprint

With direct sales, engineering support, manufacturing facilities, and distributors spanning the Americas, Europe, the Middle East, and Asia, we're close to OEMs worldwide. Our proximity helps speed delivery and lend support where and when they're needed.

Financial and Operational Stability

Kollmorgen is part of Regal Rexnord. A key driver in the growth of all Regal Rexnord segments is the Regal Rexnord Business System, which relies on the principle of "kaizen" – or continuous improvement. Using world-class tools, cross-disciplinary teams of exceptional people evaluate processes and develop plans that result in superior performance.

Kollmorgen: Your partner. In Motion.

Trademarks

AKD is a registered trademark of Kollmorgen Corporation
 AKM is a registered trademark of Kollmorgen Corporation
 Cartridge DDR is a registered trademark of Kollmorgen Corporation
 EnDat is a registered trademark of Dr. Johannes Heidenhain GmbH
 EtherCAT is a registered trademark and patented technology, licensed by Beckhoff Automation GmbH
 Ethernet/IP is a registered trademark of ODVA, Inc.
 Ethernet/IP Communication Stack: copyright (c) 2009, Rockwell Automation
 sercos® is a registered trademark of sercos® international e.V.
 HIPERFACE and HIPERFACE DSL are registered trademarks of Max Stegmann GmbH
 PROFINET is a registered trademark of PROFIBUS and PROFINET International (PI)
 SIMATIC is a registered trademark of SIEMENS AG
 SpeedTec, ytec, itec and htec are registered trademarks of TE Connectivity Ltd.
 Windows is a registered trademark of Microsoft Corporation

Table of Contents

- ▶ **AKMA Anodized Washdown Motors** 4
- ▶ **AKMA™ Design Features** 6
- ▶ **AKMA™ Performance Overview** 8
- ▶ **AKMA™ Nomenclature** 9
- ▶ **AKMA Drawings and Performance Data** 10
 - AKMA2x 10
 - AKMA3x 14
 - AKMA4x 18
 - AKMA5x 24
- ▶ **Brake & Feedback Options** 30
- ▶ **AKMA Motor Connector Pinouts** 31
- ▶ **AKMA Motor Cables** 32
 - AKMAxx Cable Properties 32
 - AKMAxx Motor to AKD2G Servo Drive Cables 33
 - AKD2G Servo Drive Cable Pinouts 33
 - AKMAxx Motor to AKD1G Servo Drive Cables 34
 - AKD1G Servo Drive Cable Pinouts 34
 - Kollmorgen 2G Cable Nomenclature 35
- ▶ **AKMA Technical Guide** 36
- ▶ **AKMA™ Hygienic Design Guide** 40
- ▶ **Universal Drive Solutions for Food, Beverage, and Pharmaceutical Industries** 41
- ▶ **AKMA™ Co-Engineered Solutions** 42
- ▶ **Kollmorgen Solutions** 43
 - Automation and Motion Control
 - Self-help Tools

AKMA™ Anodized Washdown Motors

Designed for Fast Cleaning and Increased Uptime. The AKMA stainless steel motor is designed to meet the standards for IP69K and is built with FDA approved, food-grade seals, cable connector, vent and shaft. The careful elimination of flat surfaces, cracks, and crevices prevents the build-up of foreign material and bacteria. The AKMA housing and cable can endure daily wash-downs with high pressure and high temperature. The robust design means that guards and covers are not required to protect the motor from harsh cleaning regimens. These AKMA features constitute quicker cleaning, more reliable machine performance and the increase of OEE for the entire manufacturing line.

Reduced Recall Risk. The Food Modernization Safety Act (FMSA) gives the US federal government the ability to shut down facilities, recall food products, and levy stiff fines to ensure public safety in regards to food manufacturing. The AKMA is designed to meet the toughest hygienic requirements in the industry in order to reduce the possibility of food borne illnesses and costly recalls.

Bottom Line. With 15 standard motor sizes, multiple standard windings, feedback options and vast Co-Engineering possibilities, the AKMA motor can be a great fit for diverse applications in industries such as food & beverage and pharmaceutical. Kollmorgen's AKMA environmental solutions help maintain the highest standard of machine cleanliness and increase OEE by reducing the risk of potentially devastating supplier/government recalls.





The Benefits of AKMA™ Motors

- » Increase your machine's Overall Equipment Effectiveness (OEE) with water and chemical resistant designs that maximize motor **reliability**
 - » Reduce your machine's total cost of ownership with shortened cleaning times and improved **durability**
 - » Enhance the value of your machine by **lowering** your customer's **risk of recall** through the superior hygienic design of AKMA
 - » IP69K certification of motor and cable inside the washdown environment
 - » Unique design technique to eliminate condensation inside the motor
 - » FDA Approved, food-grade O-ring seals
 - » Motor shaft material is 316L or DIN 1.4404 Stainless Steel; superior to 303/304 for corrosion resistance
 - » Round design with no nooks or crannies
 - » Sloped rear cover and connector mounting surface to eliminate puddling, even in vertical mounting
 - » No external hardware (no bolts, washers, or screws) to trap soil or pathogens or fall into food
 - » Smooth surface meeting, promotes rapid cleaning and no harboring of pathogens
 - » FDA Approved, food-grade bearing lube
 - » FDA Approved, food-grade shaft seal
 - » Cable designed to eliminate the need for conduit
 - » Hygienic, IP69K shaft seal includes special shaft treatment for long life
 - » No protective covers needed for washdown; no secondary cleaning disassembly required
 - » Hygienic marking method eliminates harboring of pathogens
 - » IP69K vent that equalizes pressure when temperature drops; e.g., during wash-down
-
- » Innovative design features **reduce** associated **cost and time** of installation.
 - » Industry leading configurability for **optimized performance**
 - » 15 frame/stack length options
 - » Windings designed for optimized machine performance
 - » Cables designed for direct connection to AKD2G and AKD servo drives (plug & play)
 - » Stainless steel connectors on motor and cables
 - » Flange mount for easy installation into application
 - » Holding brake option
 - » Single cable connection
 - » Multi-turn absolute feedback option; single-turn absolute feedback
 - » Motor auto setup with AKD/AKD2G servo drives
 - » CE/RoHS/IP69K certifications

Specify only Kollmorgen AKMA systems to ensure:

- » Reduced risk of food recall
- » Reduced cleaning time, higher OEE
- » Highest reliability and durability

AKMA™ Design Features

The key benefits of AKMA hygienic design features:

- Reduces risk of food recall
- Increases reliability in wash-down applications
- Reduces cleaning time: higher OEE

● No protective covers required
● for washdown... no secondary cleaning disassembly required

● Smooth surface promotes rapid cleaning and no harboring of pathogens

“One-piece” housing structure eliminating the O-ring and enhancing water-ingress prevention capability

Hard anodized coating with strong chemical resistance with wide pH range for withstanding common cleaning agents and enhancing durability in washdown

● Aluminum material allows for higher torque density than stainless steel motors

Standard single cable for cable cost savings, space savings, flexibility, and fewer places to harbor pathogens

● Water-tight cable exit

Chemical resistant cable for pH of 2-12, meeting IEC60364-5-52, UL, CSA, CE, RoHS

- Hygienic, IP69K shaft
- seal, special shaft
- treatment for long life

Flange Mount for easy mounting

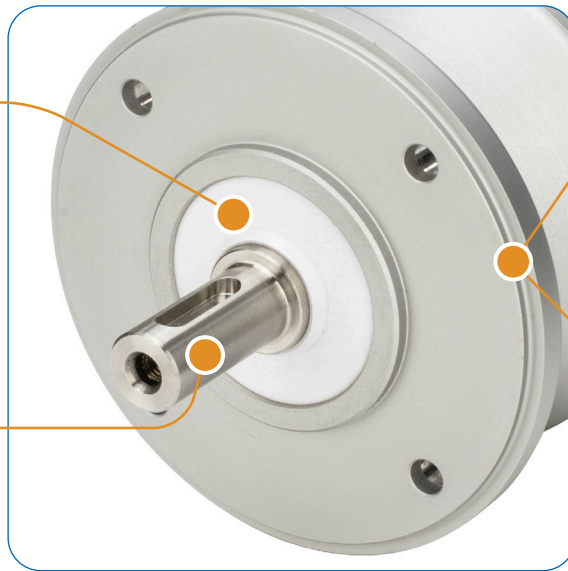

Flange compatible with common gearboxes

- Stainless steel shaft with high durability & capability to meet functional safety requirement

Unique vented connector design equalizes pressure in and outside the motor to prevent condensation inside the housing during changes of temperature

- Standard connector for easy mounting & maintenance

Viton or EPDM O-ring and gasket sealing with FDA approved materials

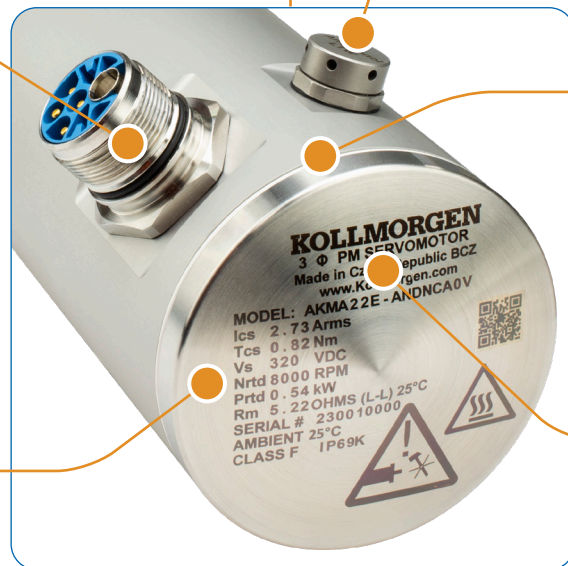

Hygienic marking method eliminates harboring of pathogens

- Conical end cover to eliminate water puddling, even in vertical mounting

AKMA™ Performance Overview

Parameters	Sym	Units	AKMA2x				AKMA3x		
			1	2	3	4	1	2	3
Continuous Torque	T_c	Nm	0.45	0.82	1.13	1.36	1.18	2.05	2.84
Rated Speed	N_{rtd}	rpm	8000	8000	8000	8000	6000	6000	5500
Rotor Inertia	J_r	kg·cm ²	0.11	0.16	0.22	0.27	0.33	0.59	0.85

Parameters	Sym	Units	AKMA4x				AKMA5x			
			1	2	3	4	1	2	3	4
Continuous Torque	T_c	Nm	1.89	3.39	4.63	5.63	4.62	8.20	10.9	13.4
Rated Speed	N_{rtd}	rpm	6000	6000	6000	6000	6000	6000	6000	6000
Rotor Inertia	J_r	kg·cm ²	0.81	1.5	2.1	2.7	3.4	6.2	9.1	12.0

Values shown are representative of each model. For exact information refer to the selection guide, installation manual, Motioneering and design tools.



AKMA Servo Motor Nomenclature

AKMA Brushless Servo Motor

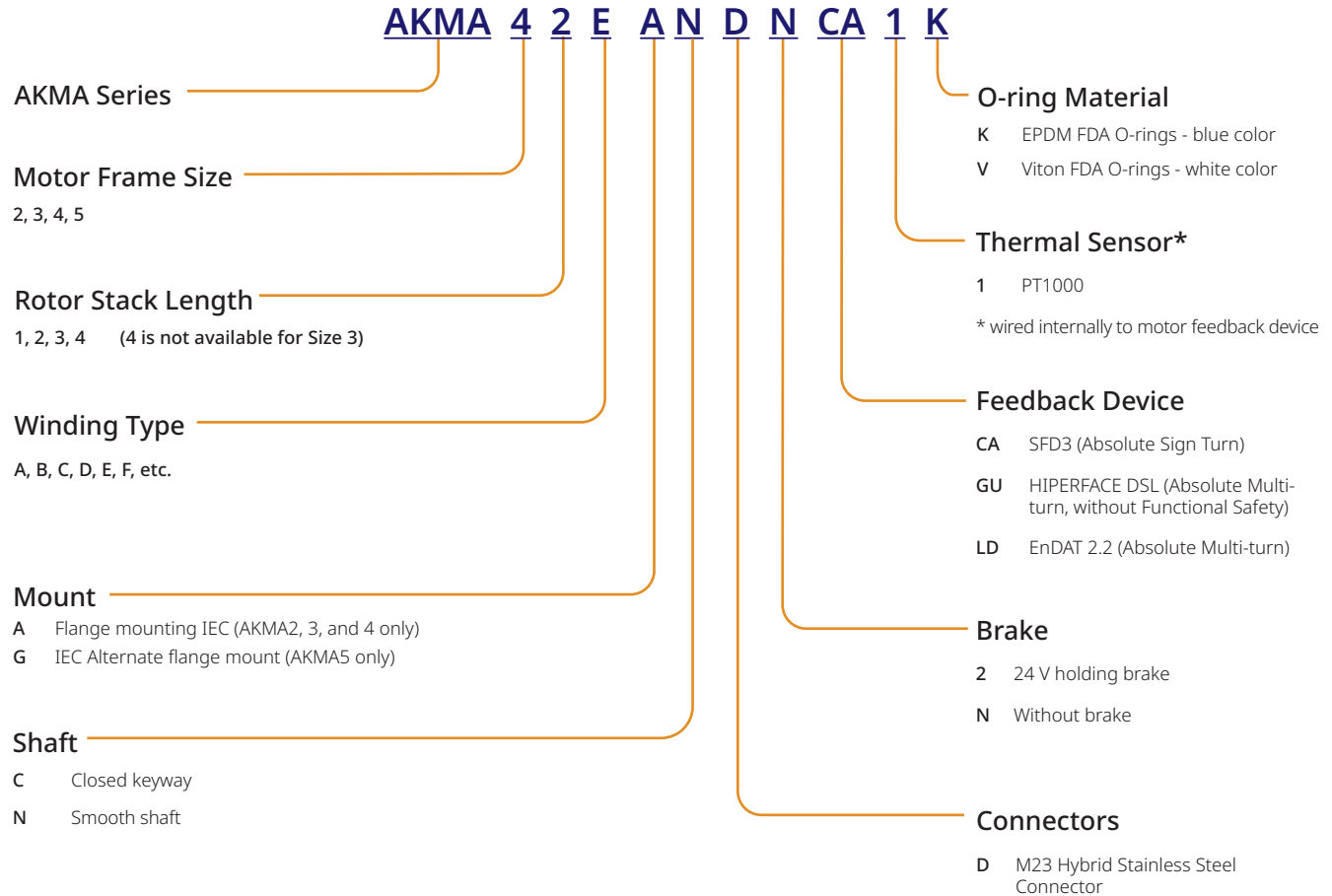

AKMA2x Performance Data

AKMA2x Performance Data – Up to 640 Vdc

Parameters	Tol	Symbol	Units	AKMA21			AKMA22			AKMA23				AKMA24			
				C	E	G	C	E	G	C	D	E	F	C	D	E	F
Max Rated Voltage	Max	Vbus	V _{AC}	240	120	-	480	240	120	480	480	240	240	480	480	240	240
			V _{DC}	320	160	75	640	320	160	640	640	320	320	640	640	320	320
Continuous Torque (Stall) for ΔT winding = 100°C ①②④⑦	Nom	T _{CS}	Nm	0.43	0.44	0.45	0.79	0.81	0.82	1.08	1.10	1.11	1.13	1.32	1.35	1.35	1.36
			lb-in	3.8	3.9	4.0	7.0	7.2	7.3	9.6	9.7	9.9	10.0	11.7	11.9	12.0	12.0
Continuous Current (Stall) for ΔT winding = 100°C ①②④⑦	Nom	I _{CS}	A _{RMS}	1.58	3.11	4.87	1.39	2.73	4.82	1.41	2.19	2.78	4.31	1.42	2.21	2.79	3.89
Continuous Torque (Stall) for ΔT winding = 60°C ②④⑦	Nom	T _{CS}	Nm	0.33	0.34	0.35	0.61	0.63	0.64	0.84	0.85	0.86	0.87	1.03	1.04	1.05	1.05
			lb-in	2.9	3.0	3.1	5.4	5.6	5.6	7.4	7.5	7.6	7.7	9.1	9.2	9.3	9.3
Max Mechanical Speed ⑤	Nom	N _{max}	rpm	8000	8000	8000	8000	8000	8000	8000	8000	8000	8000	8000	8000	8000	
Peak Torque ①②	Nom	T _p	Nm	1.47	1.49	1.51	2.73	2.76	2.79	3.77	3.84	3.86	3.88	4.73	4.76	4.79	4.82
			lb-in	13.0	13.2	13.4	24.2	24.4	24.7	33.4	34.0	34.2	34.3	41.9	42.1	42.4	42.7
Peak Current	Nom	I _p	A _{RMS}	6.3	12.4	19.5	5.6	10.9	19.3	5.6	8.8	11.1	17.2	5.7	8.8	11.2	15.6
Rated Torque (speed) ①②④⑦	75 V _{DC}	T _{rtd}	Nm	-	0.43	0.41	-	0.80	0.78	-	-	-	1.10	-	-	-	1.34
			lb-in	-	3.8	3.7	-	7.1	6.9	-	-	-	9.8	-	-	-	11.9
Rated Speed	75 V _{DC}	N _{rtd}	rpm	-	2000	4000	-	1000	2500	-	-	-	1500	-	-	-	1000
Rated Power (speed) ①②④⑦	75 V _{DC}	P _{rtd}	kW	-	0.09	0.17	-	0.08	0.20	-	-	-	0.17	-	-	-	0.14
			Hp	-	0.12	0.23	-	0.11	0.27	-	-	-	0.23	-	-	-	0.19
Rated Torque (speed) ①②④⑦	120 V _{AC} / 160 V _{DC}	T _{rtd}	Nm	0.41	0.37	0.36	0.78	0.76	0.69	1.06	1.07	1.05	1.02	-	1.31	1.29	1.28
			lb-in	3.6	3.2	3.2	6.9	6.7	6.1	9.4	9.5	9.3	9.1	-	11.6	11.4	11.4
Rated Speed	120 V _{AC} / 160 V _{DC}	N _{rtd}	rpm	2500	7000	8000	1000	3500	7000	1000	1500	2500	4500	-	1500	2000	3000
Rated Power (speed) ①②④⑦	120 V _{AC} / 160 V _{DC}	P _{rtd}	kW	0.11	0.27	0.30	0.08	0.28	0.50	0.11	0.17	0.28	0.48	-	0.21	0.27	0.40
			Hp	0.14	0.36	0.40	0.11	0.37	0.67	0.15	0.23	0.37	0.65	-	0.28	0.36	0.54
Rated Torque (speed) ①②④⑦	240 V _{AC} / 320 V _{DC}	T _{rtd}	Nm	0.34	-	-	0.73	0.65	-	1.03	0.98	0.93	0.89	1.27	1.24	1.19	1.07
			lb-in	3.0	-	-	6.5	5.7	-	9.1	8.7	8.3	7.9	11.3	11.0	10.6	9.5
Rated Speed	240 V _{AC} / 320 V _{DC}	N _{rtd}	rpm	8000	-	-	3500	8000	-	2500	5000	6500	8000	2000	4000	5500	8000
Rated Power (speed) ①②④⑦	240 V _{AC} / 320 V _{DC}	P _{rtd}	kW	0.28	-	-	0.27	0.54	-	0.27	0.51	0.64	0.75	0.27	0.52	0.69	0.90
			Hp	0.38	-	-	0.36	0.73	-	0.36	0.69	0.85	1.00	0.36	0.70	0.92	1.21
Rated Torque (speed) ①②④⑦	400 V _{AC} / 560 V _{DC}	T _{rtd}	Nm	-	-	-	0.63	-	-	0.94	0.87	-	-	1.20	1.06	-	-
			lb-in	-	-	-	5.6	-	-	8.3	7.7	-	-	10.6	9.4	-	-
Rated Speed	400 V _{AC} / 560 V _{DC}	N _{rtd}	rpm	-	-	-	8000	-	-	5500	8000	-	-	4500	8000	-	-
Rated Power (speed) ①②④⑦	400 V _{AC} / 560 V _{DC}	P _{rtd}	kW	-	-	-	0.53	-	-	0.54	0.73	-	-	0.57	0.89	-	-
			Hp	-	-	-	0.71	-	-	0.73	0.98	-	-	0.76	1.19	-	-
Rated Torque (speed) ①②④⑦	480 V _{AC} / 640 V _{DC}	T _{rtd}	Nm	-	-	-	0.63	-	-	0.90	0.87	-	-	1.17	1.06	-	-
			lb-in	-	-	-	5.6	-	-	8.0	7.7	-	-	10.4	9.4	-	-
Rated Speed	480 V _{AC} / 640 V _{DC}	N _{rtd}	rpm	-	-	-	8000	-	-	7000	8000	-	-	5500	8000	-	-
Rated Power (speed) ①②④⑦	480 V _{AC} / 640 V _{DC}	P _{rtd}	kW	-	-	-	0.53	-	-	0.66	0.73	-	-	0.68	0.89	-	-
			Hp	-	-	-	0.71	-	-	0.89	0.98	-	-	0.91	1.19	-	-

See following page for notes.

AKMA2x Performance Data – Up to 640 Vdc (Continued)

Parameters	Tol	Symbol	Units	AKMA21			AKMA22			AKMA23				AKMA24			
				C	E	G	C	E	G	C	D	E	F	C	D	E	F
Torque Constant ①②	±10%	K _t	Nm/A _{rms}	0.30	0.16	0.10	0.61	0.32	0.18	0.80	0.52	0.42	0.27	0.97	0.63	0.50	0.36
			lb-in/A _{rms}	2.7	1.4	0.9	5.4	2.8	1.6	7.1	4.6	3.7	2.4	8.6	5.6	4.5	3.2
Back EMF Constant ③	±10%	K _e	V _{rms} /krpm	19.5	10.2	6.6	39.0	20.4	11.7	51.8	33.8	27.0	17.6	62.4	40.8	32.5	23.4
Motor Constant ①	Nom	K _m	N-m/√W	0.07	0.07	0.07	0.11	0.11	0.11	0.14	0.14	0.15	0.14	0.18	0.17	0.17	0.17
			lb-in/√W	0.61	0.62	0.61	0.98	1.00	0.98	1.26	1.28	1.28	1.28	1.55	1.53	1.55	1.52
Resistance (line-line) ④	±10%	R _m	ohm	13.00	3.42	1.44	19.98	5.22	1.77	21.23	8.77	5.44	2.34	20.40	9.02	5.44	2.94
Inductance (line-line)		L	mH	19.0	5.2	2.2	35.5	9.7	3.2	40.7	17.3	11.1	4.7	43.8	18.7	11.8	6.2
Inertia (includes feedback) ⑤	±10%	J _m	kg-cm ²	0.11			0.16			0.22				0.27			
			lb-in-s ²	9.7E-05			1.4E-04			1.9E-04				2.4E-04			
Optional Brake Inertia (additional)	±10%	J _m	kg-cm ²	0.013			0.013			0.013				0.013			
			lb-in-s ²	1.2E-05			1.2E-05			1.2E-05				1.2E-05			
Weight ⑥		W	kg	1.7			2.0			2.3				2.7			
			lb	3.7			4.4			5.1				6.0			
Static Friction ①		T _f	Nm	0.049			0.051			0.054				0.057			
			lb-in	0.43			0.44			0.48				0.50			
Viscous Damping ①		K _{dv}	Nm/krpm	0.005			0.006			0.007				0.007			
			lb-in/krpm	0.04			0.05			0.06				0.07			
Thermal Time Constant		TCT	minutes	8			9			10				11			
Thermal Resistance		R _{thw-a}	°C/W	1.43			1.19			1.10				1.07			
Pole Pairs				3			3			3				3			
Heat Sink Size				10"x10"x0.25" Aluminum Plate			10"x10"x0.25" Aluminum Plate			10"x10"x0.25" Aluminum Plate				10"x10"x0.25" Aluminum Plate			

Notes:

- ① Motor winding temperature rise, ΔT=100°C, at 40 °C ambient.
- ② All data referenced to sinusoidal commutation.
- ③ Add holding brake if applicable for total inertia.
- ④ Motor with 125 °C rated feedback and standard heat sink.
- ⑤ May be limited at some values of V_{bus}.
- ⑥ Measured at 25°C.
- ⑦ Brake option reduces continuous torque rating by:
 AKMA21 = 0.00 Nm AKMA22 = 0.02 Nm AKMA23 = 0.05 Nm AKMA24 = 0.12 Nm
- ⑧ Brake option increases weight by 0.5 kg (1.1 lb)

*Complete AKMA series model nomenclature can be found on page 9.

AKMA2x Dimensional Data

AKMA 2 2 C - AN D N CA 1 K*
 Motor Series Frame Size Winding Mount/Shaft Connection Brake Feedback Thermal Sensor Seal

AKMA2x Frame

Flange Mount

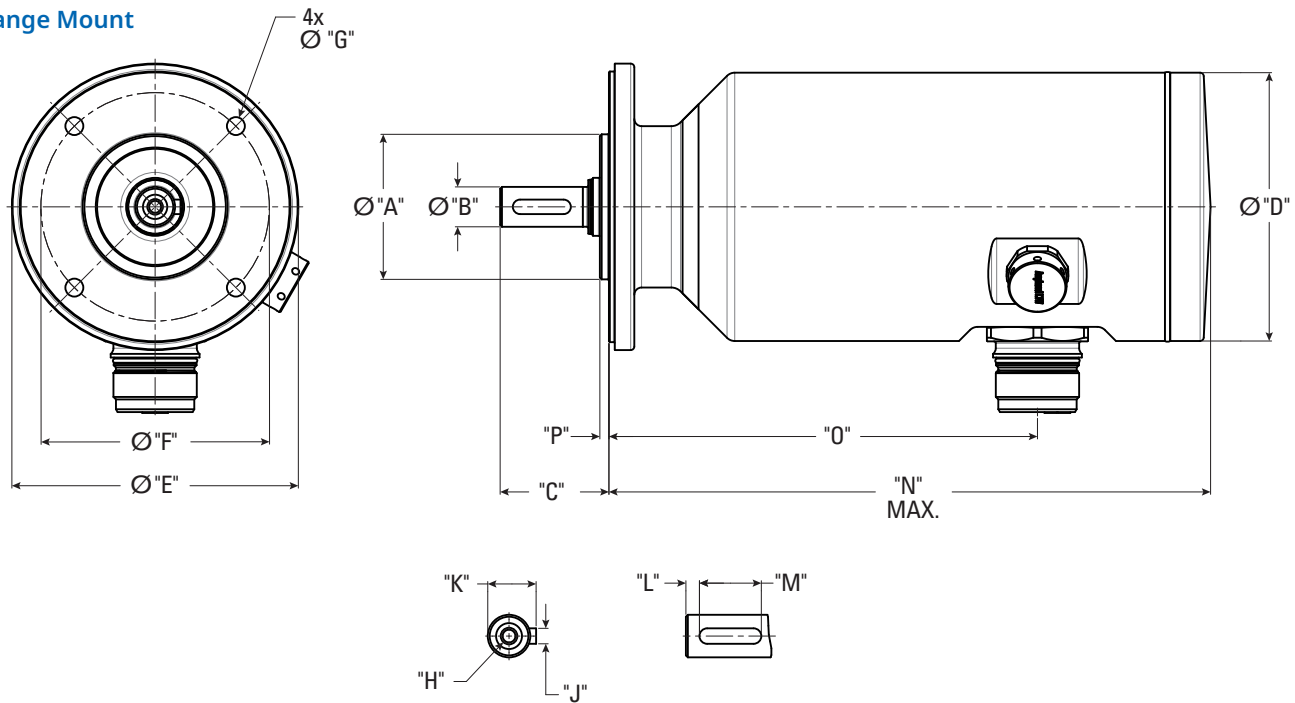

AKMA2x Dimension Data

Code	Shaft	Pilot Dia. "A"	Shaft Dia. "B"	Shaft Length "C"	Motor Body Dia. "D"	Flange Dia. "E"	Bolt Circle Dia. "F"	Bolt Hole Dia. "G"
AC	Keyway	Ø40j6	Ø11k6	30	74	79	63	4.8 +0.30/-0.0
AN	Smooth	Ø40j6	Ø11k6	30	74	79	63	4.8 +0.30/-0.0

Code	"H"	Key Height "J"	Key Width "K"	"L"	Key Length "M"	Pilot Height "P"
AC	M4 DIN332	12.5 +0/-0.13	4N9	3.5	16 +0/-0.20	2.5
AN	M4 DIN332	-	-	-	-	2.5

MODEL	Connector Position "O"		Motor Length "N"	
	W/O Brake	W/ Brake	W/O Brake	W/ Brake
AKMA21	118.2	164.8	166.2	212.8
AKMA22	137.2	183.8	185.2	231.8
AKMA23	156.2	202.8	204.2	250.8
AKMA24	175.2	221.8	223.2	269.8

Dimensions are in mm.

*Complete AKMA series model nomenclature can be found on page 9.

Notes

AKMA 2 2 C - AN D N CA 1 K*
Motor Series Frame Size Stack Length Winding Mount/Shaft Connection Brake Feedback Thermal Sensor Seal

A large grid of graph paper for taking notes, consisting of a 20x20 grid of major squares, each of which is further divided into a 10x10 grid of smaller squares.

2 mm divisions

*Complete AKMA series model nomenclature can be found on page 9.

AKMA3x Performance Data

AKMA3x Performance Data – Up to 640 Vdc

Parameters	Tol	Symbol	Units	AKMA31			AKMA32				AKMA33		
				C	E	H	C	D	E	H	C	E	H
Max Rated Voltage	Max	V _{bus}	V _{AC}	480	240	120	480	480	480	240	480	480	240
			V _{DC}	640	320	160	640	640	640	320	640	640	320
Continuous Torque (Stall) for ΔT winding = 100°C ①②④⑦	Nom	T _{CS}	Nm	1.10	1.15	1.18	1.95	1.98	1.99	2.05	2.66	2.75	2.84
			lb-in	9.8	10.2	10.5	17.2	17.5	17.6	18.2	23.6	24.3	25.1
Continuous Current (Stall) for ΔT winding = 100°C ①②④⑦	Nom	I _{CS}	A _{rms}	1.37	2.99	5.85	1.44	2.23	2.82	5.50	1.47	2.58	5.62
Continuous Torque (Stall) for ΔT winding = 60°C ②④⑦	Nom	T _{CS}	Nm	0.85	0.89	0.92	1.51	1.53	1.54	1.59	2.06	2.13	2.20
			lb-in	7.6	7.9	8.1	13.4	13.6	13.7	14.1	18.3	18.9	19.4
Max Mechanical Speed ⑤	Nom	N _{max}	rpm	8000	8000	8000	8000	8000	8000	8000	8000	8000	8000
Peak Torque ①②	Nom	T _p	Nm	3.88	4.00	4.06	7.01	7.06	7.12	7.26	9.76	9.96	10.21
			lb-in	34.3	35.4	35.9	62.0	62.5	63.0	64.3	86.4	88.1	90.4
Peak Current	Nom	I _p	A _{rms}	5.5	12.0	23.4	5.8	8.9	11.3	22.0	5.9	10.3	22.5
Rated Torque (speed) ①②④⑦		T _{rtd}	Nm	-	1.12	0.92	-	1.95	1.96	1.91	-	-	2.61
			lb-in	-	9.9	8.2	-	17.3	17.4	16.9	-	-	23.1
Rated Speed		N _{rtd}	rpm	-	2500	6000	-	1000	1000	3000	-	-	2500
Rated Power (speed) ①②④⑦		P _{rtd}	kW	-	0.29	0.58	-	0.20	0.21	0.60	-	-	0.68
			Hp	-	0.39	0.78	-	0.27	0.28	0.81	-	-	0.92
Rated Torque (speed) ①②④⑦		T _{rtd}	Nm	1.07	0.90	-	1.90	1.88	1.86	1.40	2.59	2.57	2.22
			lb-in	9.5	8.0	-	16.8	16.7	16.5	12.4	22.9	22.8	19.7
Rated Speed		N _{rtd}	rpm	2500	6000	-	1500	2500	3000	7000	1000	2000	5500
Rated Power (speed) ①②④⑦		P _{rtd}	kW	0.28	0.57	-	0.30	0.49	0.59	1.03	0.27	0.54	1.28
			Hp	0.38	0.76	-	0.40	0.66	0.78	1.38	0.36	0.72	1.72
Rated Torque (speed) ①②④⑦		T _{rtd}	Nm	0.95	-	-	1.81	1.60	1.45	-	2.49	2.29	-
			lb-in	8.4	-	-	16.0	14.2	12.9	-	22.1	20.3	-
Rated Speed		N _{rtd}	rpm	5000	-	-	3000	5500	6500	-	2000	4500	-
Rated Power (speed) ①②④⑦		P _{rtd}	kW	0.50	-	-	0.57	0.92	0.99	-	0.52	1.08	-
			Hp	0.67	-	-	0.76	1.24	1.33	-	0.70	1.45	-
Rated Torque (speed) ①②④⑦		T _{rtd}	Nm	0.86	-	-	1.78	1.53	1.17	-	2.45	2.22	-
			lb-in	7.6	-	-	15.8	13.6	10.4	-	21.7	19.7	-
Rated Speed		N _{rtd}	rpm	6000	-	-	3500	6000	8000	-	2500	5000	-
Rated Power (speed) ①②④⑦		P _{rtd}	kW	0.54	-	-	0.65	0.96	0.98	-	0.64	1.16	-
			Hp	0.73	-	-	0.88	1.29	1.32	-	0.86	1.56	-

See following page for notes.

AKMA3x Performance Data – Up to 640 Vdc (Continued)

Parameters	Tol	Symbol	Units	AKMA31			AKMA32				AKMA33		
				C	E	H	C	D	E	H	C	E	H
Torque Constant ①②	±10%	K_t	Nm/A _{rms}	0.85	0.41	0.21	1.40	0.92	0.73	0.39	1.86	1.10	0.52
			lb-in/A _{rms}	7.5	3.6	1.9	12.3	8.1	6.5	3.4	16.5	9.7	4.6
Back EMF Constant ③	±10%	K_e	V _{rms} /krpm	54.5	26.1	13.7	89.8	59.0	47.1	24.8	120.0	70.6	33.4
Motor Constant ①	Nom	K_m	N-m/√W	0.149	0.152	0.151	0.234	0.233	0.235	0.239	0.295	0.298	0.299
			lb-in/√W	1.32	1.35	1.34	2.07	2.06	2.08	2.12	2.61	2.64	2.64
Resistance (line-line) ④	±10%	R_m	ohm	21.40	4.74	1.29	23.76	10.30	6.32	1.69	26.59	9.01	1.96
Inductance (line-line)		L	mH	37.5	8.6	2.4	46.5	20.1	12.8	3.5	53.6	18.5	4.1
Inertia (includes feedback) ⑤	±10%	J_m	kg-cm ²	0.33			0.59				0.85		
			lb-in-s ²	2.9E-04			5.2E-04				7.5E-04		
Optional Brake Inertia (additional)	±10%	J_m	kg-cm ²	0.014			0.014				0.014		
			lb-in-s ²	1.2E-05			1.2E-05				1.2E-05		
Weight ⑥		W	kg	2.3			3.1				3.8		
			lb	5.1			6.8				8.4		
Static Friction ①		T_f	Nm	0.061			0.067				0.073		
			lb-in	0.54			0.59				0.65		
Viscous Damping ①		K_{dv}	Nm/krpm	0.002			0.003				0.004		
			lb-in/krpm	0.02			0.03				0.04		
Thermal Time Constant		TCT	minutes	14			17				20		
Thermal Resistance		R_{thw-a}	°C/W	1.11			0.92				0.78		
Pole Pairs				4			4				4		
Heat Sink Size				10"x10"x0.25" Aluminum Plate			10"x10"x0.25" Aluminum Plate				10"x10"x0.25" Aluminum Plate		

Notes:

- ① Motor winding temperature rise, ΔT=100°C, at 40 °C ambient.
- ② All data referenced to sinusoidal commutation.
- ③ Add holding brake if applicable for total inertia.
- ④ Motor with 125 °C rated feedback and standard heat sink.
- ⑤ May be limited at some values of V_{bus}.
- ⑥ Measured at 25°C.
- ⑦ Brake option reduces continuous torque rating by:
AKMA31 = 0.00 Nm AKMA32 = 0.1 Nm AKMA33 = 0.2 Nm
- ⑧ Brake option increases weight by 0.6 kg (1.3 lb)

*Complete AKMA series model nomenclature can be found on page 9.

AKMA3x Dimensional Data

AKMA 3 2 C - AN D N CA 1 K*
 Motor Series Frame Size Winding Stack Length Mount/Shaft Connection Brake Feedback Thermal Sensor Seal

AKMA3x Frame

Flange Mount

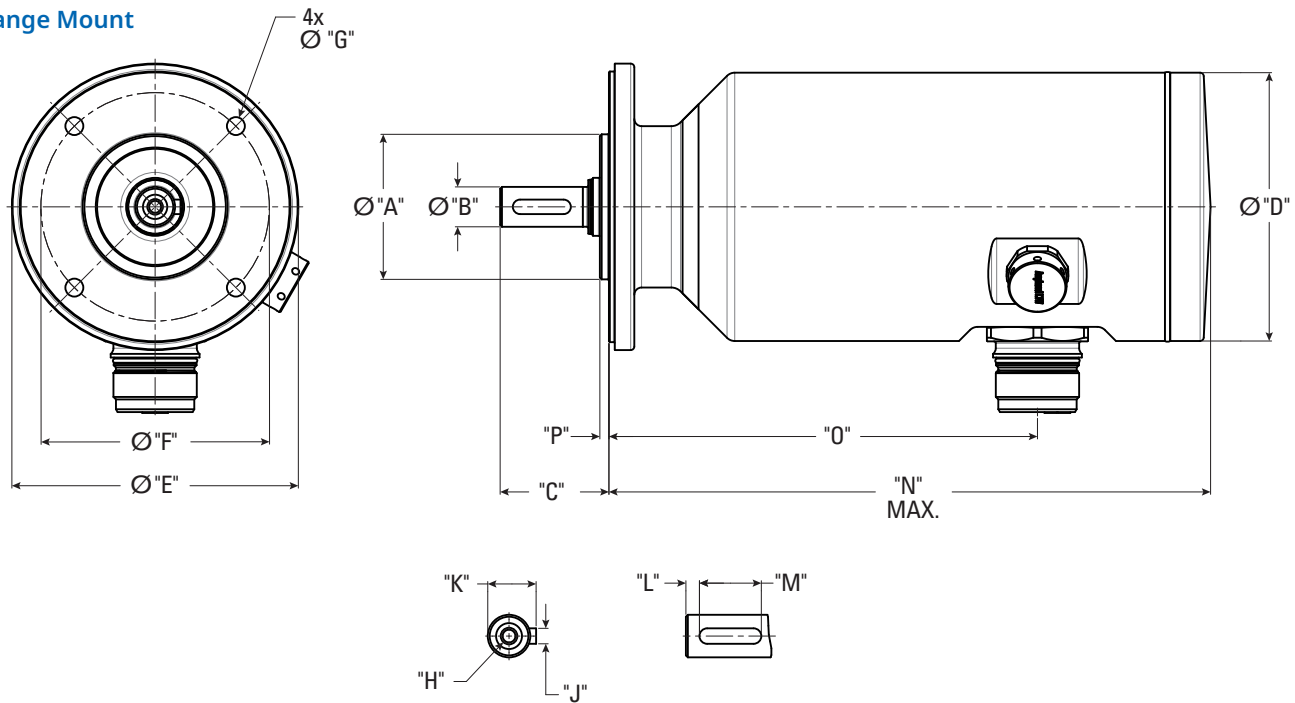

AKMA3x Dimension Data

Code	Shaft	Pilot Dia. "A"	Shaft Dia. "B"	Shaft Length "C"	Motor Body Dia. "D"	Flange Dia. "E"	Bolt Circle Dia. "F"	Bolt Hole Dia. "G"
AC	Keyway	Ø60j6	Ø14k6	30	85	89	75	5.8 +0.30/-0.0
AN	Smooth	Ø60j6	Ø14k6	30	85	89	75	5.8 +0.30/-0.0

Code	"H"	Key Height "J"	Key Width "K"	"L"	Key Length "M"	Pilot Height "P"
AC	M5 DIN332	16+0/-0.13	5N9	3.5	16 +0/-0.20	2.5
AN	M5 DIN332	-	-	-	-	2.5

MODEL	Connector Position "O"		Motor Length "N"	
	W/O Brake	W/ Brake	W/O Brake	W/ Brake
AKMA31	118.3	156.3	166.4	204.3
AKMA32	149.3	187.3	197.4	235.3
AKMA33	180.3	218.3	228.4	266.34

Dimensions are in mm.

*Complete AKMA series model nomenclature can be found on page 9.

Notes

AKMA | **3** | **2** | **C** | **-** | **AN** | **D** | **N** | **CA** | **1** | **K***
Motor Series | Frame Size | Stack Length | Winding | Mount/Shaft | Connection | Brake | Feedback | Thermal Sensor | Seal

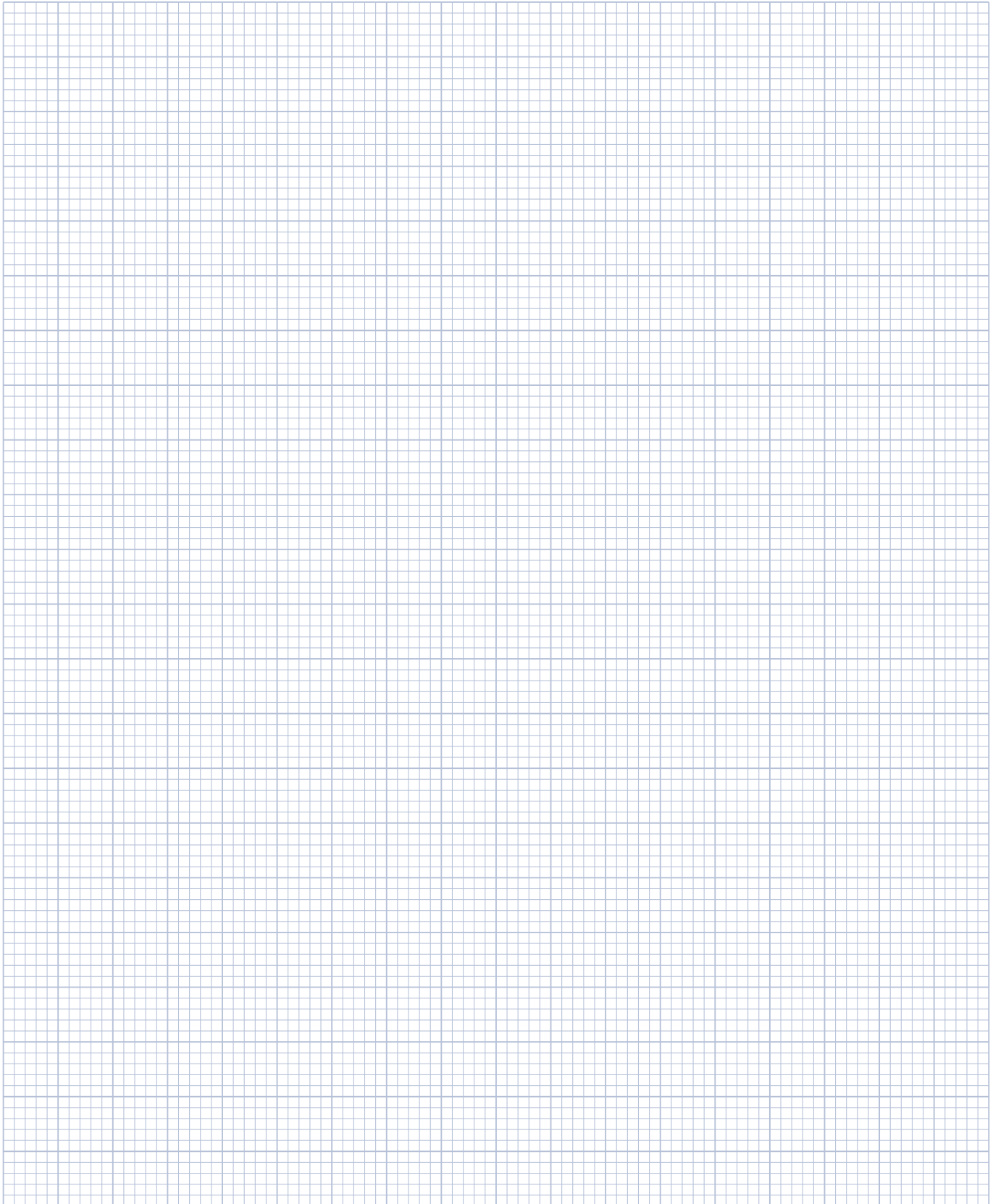

2 mm divisions

*Complete AKMA series model nomenclature can be found on page 9.

AKMA4x Performance Data

AKMA4x Performance Data – Up to 640 Vdc

Parameters	Tol	Symbol	Units	AKMA41			AKMA42				
				C	E	H	C	E	G	H	J
Max Rated Voltage	Max	V _{bus}	V _{AC}	480	480	240	480	480	480	240	240
			V _{DC}	640	640	320	640	640	640	320	320
Continuous Torque (Stall) for ΔT winding = 100°C ①②④⑦	Nom	T _{CS}	Nm	1.78	1.85	1.89	3.18	3.25	3.36	3.37	3.39
			lb-in	15.7	16.4	16.7	28.1	28.8	29.7	29.8	30.0
Continuous Current (Stall) for ΔT winding = 100°C ①②④⑦	Nom	I _{CS}	A _{RMS}	1.39	2.73	5.36	1.37	2.66	4.68	5.83	8.16
Continuous Torque (Stall) for ΔT winding = 60°C ②④⑦	Nom	T _{CS}	Nm	1.38	1.43	1.46	2.46	2.52	2.60	2.61	2.63
			lb-in	12.2	12.7	12.9	21.8	22.3	23.0	23.1	23.2
Max Mechanical Speed ⑤	Nom	N _{max}	rpm	6000	6000	6000	6000	6000	6000	6000	6000
Peak Torque ①②	Nom	T _p	Nm	6.12	6.28	6.36	11.10	11.30	11.50	11.60	11.60
			lb-in	54.2	55.6	56.3	98.2	100.0	101.8	102.7	102.7
Peak Current	Nom	I _p	A _{RMS}	5.8	11.4	22.4	5.6	11.0	19.2	24.0	33.7
Rated Torque (speed) ①②④⑦		T _{rtd}	Nm	-	1.77	1.69	-	-	-	3.03	2.86
			lb-in	-	15.7	14.9	-	-	-	26.8	25.3
Rated Speed		N _{rtd}	rpm	-	1200	3000	-	-	-	2000	3000
Rated Power (speed) ①②④⑦		P _{rtd}	kW	-	0.22	0.53	-	-	-	0.63	0.90
			Hp	-	0.30	0.71	-	-	-	0.85	1.20
Rated Torque (speed) ①②④⑦		T _{rtd}	Nm	1.71	1.65	1.45	-	2.95	2.73	2.55	2.21
			lb-in	15.1	14.6	12.8	-	26.1	24.2	22.6	19.5
Rated Speed		N _{rtd}	rpm	1200	3000	6000	-	1800	3500	4500	6000
Rated Power (speed) ①②④⑦		P _{rtd}	kW	0.21	0.52	0.91	-	0.56	1.00	1.20	1.39
			Hp	0.29	0.69	1.22	-	0.75	1.34	1.61	1.86
Rated Torque (speed) ①②④⑦		T _{rtd}	Nm	1.60	1.41	-	2.93	2.64	2.18	-	-
			lb-in	14.2	12.5	-	25.9	23.4	19.3	-	-
Rated Speed		N _{rtd}	rpm	3000	6000	-	1500	3500	6000	-	-
Rated Power (speed) ①②④⑦		P _{rtd}	kW	0.50	0.89	-	0.46	0.97	1.37	-	-
			Hp	0.67	1.19	-	0.62	1.30	1.84	-	-
Rated Torque (speed) ①②④⑦		T _{rtd}	Nm	1.57	1.41	-	2.85	2.55	2.18	-	-
			lb-in	13.9	12.5	-	25.2	22.6	19.3	-	-
Rated Speed		N _{rtd}	rpm	3500	6000	-	2000	4000	6000	-	-
Rated Power (speed) ①②④⑦		P _{rtd}	kW	0.58	0.89	-	0.60	1.07	1.37	-	-
			Hp	0.77	1.19	-	0.80	1.43	1.84	-	-

See following page for notes.

AKMA4x Performance Data – Up to 640 Vdc (Continued)

Parameters	Tol	Symbol	Units	AKMA41			AKMA42				
				C	E	G	C	E	G	H	J
Torque Constant ①②	±10%	K_t	Nm/A _{rms}	1.34	0.71	0.37	2.40	1.26	0.74	0.59	0.43
			lb-in/A _{rms}	11.9	6.3	3.3	21.2	11.1	6.5	5.3	3.8
Back EMF Constant ③	±10%	K_e	V _{rms} /krpm	86.3	45.6	23.7	154.3	80.9	47.5	38.3	27.5
Motor Constant ①	Nom	K_m	N-m/√W	0.24	0.24	0.24	0.37	0.37	0.38	0.37	0.39
			lb-in/√W	2.10	2.09	2.11	3.30	3.25	3.33	3.31	3.41
Resistance (line-line) ④	±10%	R_m	ohm	21.30	6.02	1.56	27.50	7.78	2.51	1.65	0.80
Inductance (line-line)		L	mH	66.1	18.4	5.0	97.4	26.8	9.2	6.0	3.1
Inertia (includes feedback) ⑤	±10%	J_m	kg-cm ²	0.81			1.50				
			lb-in-s ²	7.2E-04			1.3E-03				
Optional Brake Inertia (additional)	±10%	J_m	kg-cm ²	0.058			0.058				
			lb-in-s ²	5.1E-05			5.1E-05				
Weight ⑥		W	kg	3.7			4.9				
			lb	8.2			10.8				
Static Friction ①		T_f	Nm	0.085			0.097				
			lb-in	0.75			0.86				
Viscous Damping ①		K_{dv}	Nm/krpm	0.0090			0.0130				
			lb-in/krpm	0.08			0.12				
Thermal Time Constant		TCT	minutes	13			17				
Thermal Resistance		R_{thw-a}	°C/W	0.97			0.80				
Pole Pairs				5			5				
Heat Sink Size				10"x10"x0.25" Aluminum Plate			10"x10"x0.25" Aluminum Plate				

Notes:

- ① Motor winding temperature rise, ΔT=100°C, at 40 °C ambient.
- ② All data referenced to sinusoidal commutation.
- ③ Add holding brake if applicable for total inertia.
- ④ Motor with 125 °C rated feedback and standard heat sink.
- ⑤ May be limited at some values of V_{bus}.
- ⑥ Measured at 25°C.
- ⑦ Brake option reduces continuous torque rating by:
 AKMA41 = 0.12 Nm AKMA42 = 0.26 Nm AKMA43 = 0.35 Nm AKMA44 = 0.46 Nm
- ⑧ Brake option increases weight by 1.3 kg (2.9 lb)

*Complete AKMA series model nomenclature can be found on page 9.

AKMA4x Performance Data

AKMA4x Performance Data – Up to 640 Vdc (Continued)

Parameters	Tol	Symbol	Units	AKMA43					AKMA44				
				E	G	H	K	L	E	G	H	J	K
Max Rated Voltage	Max	V _{bus}	V _{AC}	480	480	480	240	240	480	480	480	480	240
			V _{DC}	640	640	640	320	320	640	640	640	640	320
Continuous Torque (Stall) for ΔT winding = 100°C ①②④⑦	Nom	T _{CS}	Nm	4.43	4.53	4.55	4.63	4.46	5.39	5.51	5.52	5.63	5.51
			lb-in	39.2	40.1	40.3	41.0	39.5	47.7	48.8	48.8	49.8	48.8
Continuous Current (Stall) for ΔT winding = 100°C ①②④⑦	Nom	I _{CS}	A _{RMS}	2.64	4.67	5.23	9.19	10.70	2.70	4.73	5.34	8.38	9.59
Continuous Torque (Stall) for ΔT winding = 60°C ②④⑦	Nom	T _{CS}	Nm	3.43	3.51	3.52	3.59	3.45	4.17	4.27	4.27	4.36	4.27
			lb-in	30.4	31.0	31.2	31.7	30.6	36.9	37.8	37.8	38.6	37.8
Max Mechanical Speed ⑤	Nom	N _{max}	rpm	6000	6000	6000	6000	6000	6000	6000	6000	6000	6000
Peak Torque ①②	Nom	T _p	Nm	15.90	16.10	16.10	16.40	16.00	20.20	20.30	20.20	20.50	20.20
			lb-in	140.7	142.5	142.5	145.1	141.6	178.8	179.7	178.8	181.4	178.8
Peak Current	Nom	I _p	A _{RMS}	11.0	19.5	21.6	38.4	44.6	11.6	20.0	22.4	35.2	40.4
Rated Torque (speed) ①②④⑦		T _{rtd}	Nm	-	-	4.19	3.81	3.51	-	-	5.07	-	4.53
			lb-in	-	-	37.1	33.7	31.1	-	-	44.9	-	40.1
Rated Speed		N _{rtd}	rpm	-	-	1200	2500	3000	-	-	1000	-	2000
Rated Power (speed) ①②④⑦		P _{rtd}	kW	-	-	0.53	1.00	1.10	-	-	0.53	-	0.95
			Hp	-	-	0.71	1.34	1.48	-	-	0.71	-	1.27
Rated Torque (speed) ①②④⑦		T _{rtd}	Nm	3.97	3.73	3.59	2.35	2.26	4.85	4.53	4.29	3.47	2.81
			lb-in	35.1	33.0	31.8	20.8	20.0	42.9	40.1	38.0	30.7	24.9
Rated Speed		N _{rtd}	rpm	1500	2500	3000	6000	6000	1200	2000	2500	4000	5000
Rated Power (speed) ①②④⑦		P _{rtd}	kW	0.62	0.98	1.13	1.48	1.42	0.61	0.95	1.12	1.45	1.47
			Hp	0.84	1.31	1.51	1.98	1.90	0.82	1.27	1.51	1.95	1.97
Rated Torque (speed) ①②④⑦		T _{rtd}	Nm	3.65	2.74	2.54	-	-	4.43	2.81	3.11	2.38	-
			lb-in	32.3	24.2	22.5	-	-	39.2	24.9	27.5	21.1	-
Rated Speed		N _{rtd}	rpm	2500	5000	5500	-	-	2000	5000	4500	6000	-
Rated Power (speed) ①②④⑦		P _{rtd}	kW	0.96	1.43	1.46	-	-	0.93	1.47	1.46	1.49	-
			Hp	1.28	1.92	1.96	-	-	1.24	1.97	1.96	2.00	-
Rated Torque (speed) ①②④⑦		T _{rtd}	Nm	3.49	2.30	2.31	-	-	4.19	2.57	2.56	2.38	-
			lb-in	30.9	20.3	20.4	-	-	37.1	22.7	22.6	21.1	-
Rated Speed		N _{rtd}	rpm	3000	6000	6000	-	-	2500	5500	5500	6000	-
Rated Power (speed) ①②④⑦		P _{rtd}	kW	1.10	1.44	1.45	-	-	1.10	1.48	1.47	1.49	-
			Hp	1.47	1.94	1.95	-	-	1.47	1.98	1.98	2.00	-

See following page for notes.

AKMA4x Performance Data – Up to 640 Vdc (Continued)

Parameters	Tol	Symbol	Units	AKMA43					AKMA44				
				E	G	H	K	L	E	G	H	J	K
Torque Constant ①②	±10%	K_t	Nm/A _{rms}	1.72	0.99	0.89	0.52	0.43	2.04	1.19	1.06	0.69	0.59
			lb-in/A _{rms}	15.2	8.8	7.9	4.6	3.8	18.1	10.5	9.3	6.1	5.2
Back EMF Constant ③	±10%	K_e	V _{rms} /krpm	110.8	63.9	57.4	33.2	27.5	131.6	76.6	68.0	44.2	37.8
Motor Constant ①	Nom	K_m	N-m/√W	0.48	0.48	0.49	0.48	0.46	0.57	0.58	0.57	0.57	0.57
			lb-in/√W	4.24	4.28	4.29	4.28	4.04	5.02	5.14	5.05	5.06	5.01
Resistance (line-line) ④	±10%	R_m	ohm	8.61	2.81	2.20	0.74	0.57	8.64	2.80	2.23	0.94	0.70
Inductance (line-line)		L	mH	32.6	10.8	8.7	2.9	2.0	33.9	11.5	9.1	3.8	0.7
Inertia (includes feedback) ⑤	±10%	J_m	kg-cm ²	2.10					2.70				
			lb-in-s ²	1.9E-03					2.4E-03				
Optional Brake Inertia (additional)	±10%	J_m	kg-cm ²	0.058					0.058				
			lb-in-s ²	5.1E-05					5.1E-05				
Weight ⑥		W	kg	6.1					7.3				
			lb	13.4					16.1				
Static Friction ①		T_f	Nm	0.11					0.12				
			lb-in	0.96					1.07				
Viscous Damping ①		K_{dv}	Nm/krpm	0.017					0.021				
			lb-in/krpm	0.15					0.19				
Thermal Time Constant		TCT	minutes	20					24				
Thermal Resistance		R_{thw-a}	°C/W	0.70					0.65				
Pole Pairs				5					5				
Heat Sink Size				10"x10"x0.25" Aluminum Plate					10"x10"x0.25" Aluminum Plate				

Notes:

- ① Motor winding temperature rise, ΔT=100°C, at 40 °C ambient.
- ② All data referenced to sinusoidal commutation.
- ③ Add holding brake if applicable for total inertia.
- ④ Motor with 125 °C rated feedback and standard heat sink.
- ⑤ May be limited at some values of V_{bus}.
- ⑥ Measured at 25°C.
- ⑦ Brake option reduces continuous torque rating by:
 AKMA41 = 0.12 Nm AKMA42 = 0.26 Nm AKMA43 = 0.35 Nm AKMA44 = 0.46 Nm
- ⑧ Brake option increases weight by 1.3 kg (2.9 lb)

*Complete AKMA series model nomenclature can be found on page 9.

AKMA4x Dimensional Data

AKMA 4 2 C - AN D N CA 1 K*
 Motor Series Frame Size Winding Stack Length Mount/Shaft Connection Brake Feedback Thermal Sensor Seal

AKMA4x Frame

Flange Mount

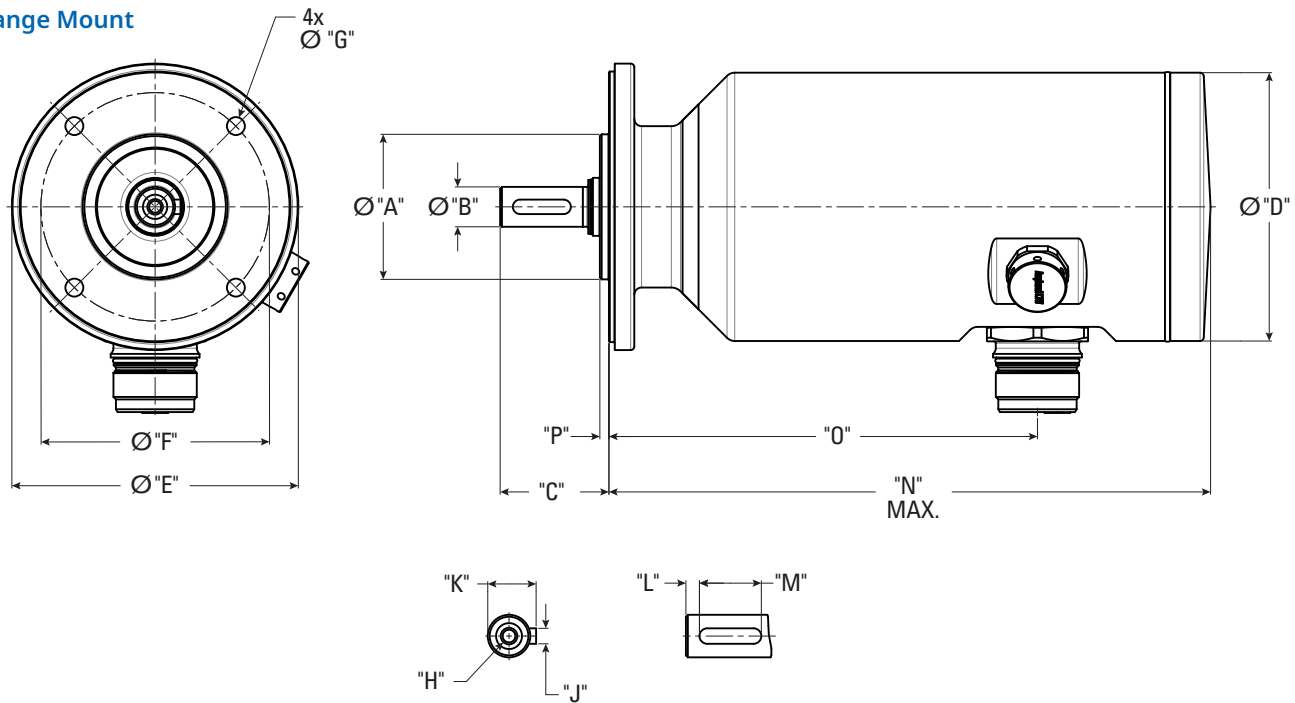

AKMA4x Dimension Data

Code	Shaft	Pilot Dia. "A"	Shaft Dia. "B"	Shaft Length "C"	Motor Body Dia. "D"	Flange Dia. "E"	Bolt Circle Dia. "F"	Bolt Hole Dia. "G"
AC	Keyway	Ø80j6	Ø19k6	40	113	117	100	7 +0.3/-0.0
AN	Smooth	Ø80j6	Ø19k6	40	113	117	100	7 +0.3/-0.0

Code	"H"	Key Height "J"	Key Width "K"	"L"	Key Length "M"	Pilot Height "P"
AC	M6 DIN332	21.5 +0/-0.13	6N9	4	25+0/-0.3	3.0
AN	M6 DIN332	-	-	-	-	3.0

MODEL	Connector Position "O"		Motor Length "N"	
	W/O Brake	W/ Brake	W/O Brake	W/ Brake
AKMA41	122.7	165.9	171.4	214.5
AKMA42	151.7	194.9	200.4	243.5
AKMA43	180.7	223.9	229.4	272.5
AKMA44	209.7	252.9	258.4	301.5

Dimensions are in mm.

*Complete AKMA series model nomenclature can be found on page 9.

Notes

AKMA | **4** | **2** | **C** | **-** | **AN** | **D** | **N** | **CA** | **1** | **K***
Motor Series | Frame Size | Stack Length | Winding | Mount/Shaft | Connection | Brake | Feedback | Thermal Sensor | Seal

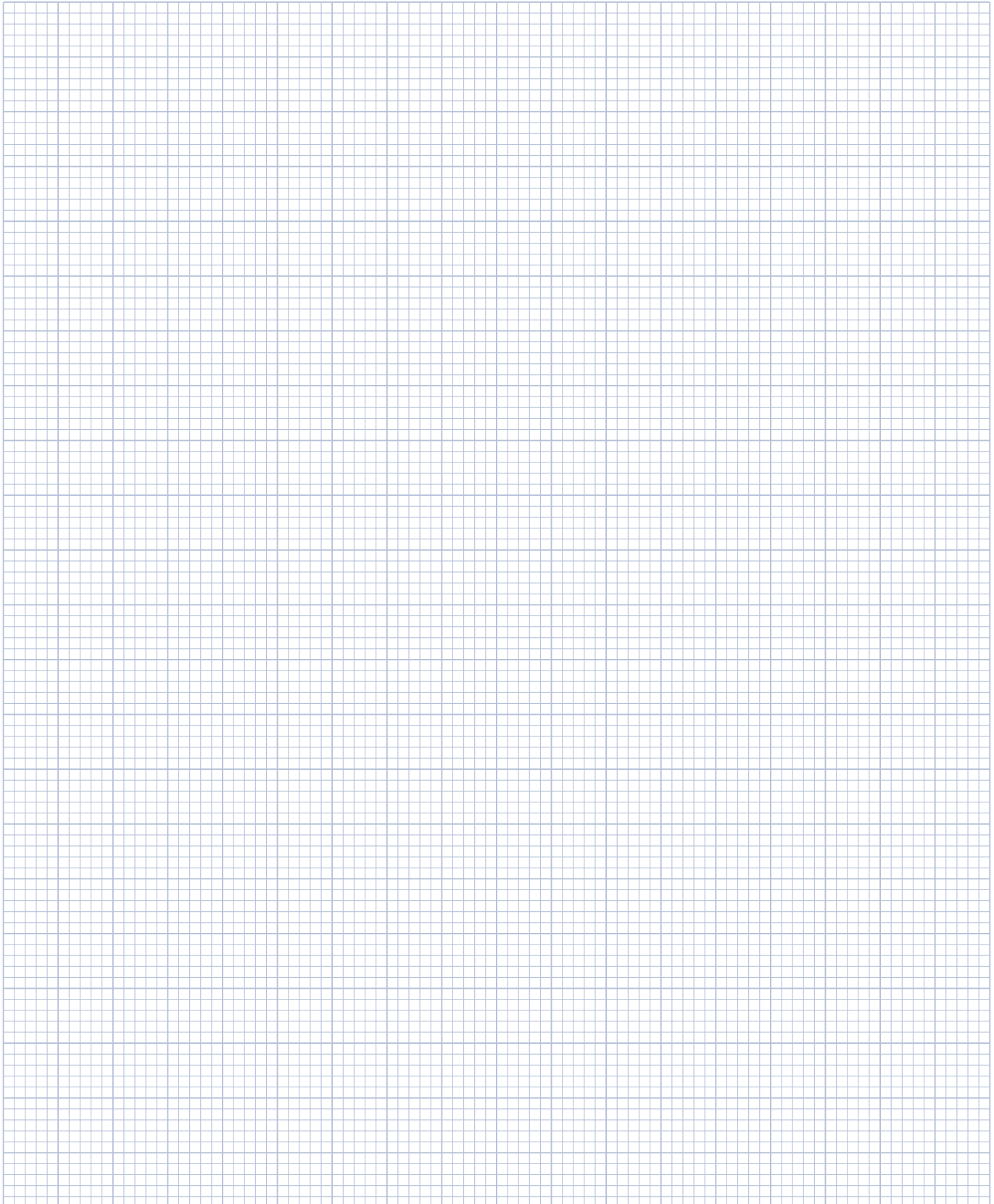

2 mm divisions

*Complete AKMA series model nomenclature can be found on page 9.

AKMA5x Performance Data

AKMA5x Performance Data – Up to 640 Vdc

Parameters	Tol	Symbol	Units	AKMA51					AKMA52				
				E	G	H	K	L	E	G	H	L	M
Max Rated Voltage	Max	V _{bus}	V _{AC}	480	480	480	240	240	480	480	480	480	240
			V _{DC}	640	640	640	320	320	640	640	640	640	320
Continuous Torque (Stall) for ΔT winding = 100°C ①②④⑦	Nom	T _{CS}	Nm	4.42	4.47	4.51	4.62	4.61	7.87	7.96	8.01	8.20	8.13
			lb-in	39.1	39.6	39.9	40.9	40.8	69.6	70.4	70.9	72.6	72.0
Continuous Current (Stall) for ΔT winding = 100°C ①②④⑦	Nom	I _{CS}	A _{rms}	2.67	4.68	5.85	9.17	11.53	2.89	4.54	5.68	11.16	12.60
Continuous Torque (Stall) for ΔT winding = 60°C ②④⑦	Nom	T _{CS}	Nm	3.42	3.46	3.49	3.58	3.57	6.10	6.17	6.20	6.35	6.30
			lb-in	30.3	30.6	30.9	31.7	31.6	54.0	54.6	54.9	56.2	55.7
Max Mechanical Speed ⑤	Nom	N _{max}	rpm	6000	6000	6000	6000	6000	6000	6000	6000	6000	6000
Peak Torque ①②	Nom	T _p	Nm	11.60	11.70	11.70	11.90	12.00	21.30	21.50	21.60	22.00	21.90
			lb-in	102.7	103.5	103.5	105.3	106.2	188.5	190.3	191.2	194.7	193.8
Peak Current	Nom	I _p	A _{rms}	8.2	14.5	18.0	28.2	35.7	9.0	14.2	17.7	34.8	39.4
Rated Torque (speed) ①②④⑦		T _{rtd}	Nm	-	-	4.18	3.87	3.67	-	-	-	7.42	-
			lb-in	-	-	37.0	34.2	32.5	-	-	-	65.7	-
Rated Speed		N _{rtd}	rpm	-	-	1200	2500	3000	-	-	-	2500	-
Rated Power (speed) ①②④⑦		P _{rtd}	kW	-	-	0.53	1.01	1.15	-	-	-	1.94	-
			Hp	-	-	0.70	1.36	1.55	-	-	-	2.60	-
Rated Torque (speed) ①②④⑦		T _{rtd}	Nm	4.13	3.74	3.59	2.07	1.72	-	7.22	7.06	5.93	4.73
			lb-in	36.6	33.1	31.8	18.3	15.2	-	63.9	62.5	52.5	41.9
Rated Speed		N _{rtd}	rpm	1200	2500	3000	5500	6000	-	1500	1800	3500	4500
Rated Power (speed) ①②④⑦		P _{rtd}	kW	0.52	0.98	1.13	1.19	1.08	-	1.13	1.33	2.17	2.23
			Hp	0.70	1.31	1.51	1.60	1.45	-	1.52	1.78	2.91	2.99
Rated Torque (speed) ①②④⑦		T _{rtd}	Nm	3.70	2.34	1.69	-	-	7.14	6.59	5.79	2.80	-
			lb-in	32.7	20.7	15.0	-	-	63.2	58.3	51.2	24.8	-
Rated Speed		N _{rtd}	rpm	2500	5000	6000	-	-	1500	2500	3500	6000	-
Rated Power (speed) ①②④⑦		P _{rtd}	kW	0.97	1.23	1.06	-	-	1.12	1.73	2.12	1.76	-
			Hp	1.30	1.64	1.42	-	-	1.50	2.31	2.85	2.36	-
Rated Torque (speed) ①②④⑦		T _{rtd}	Nm	3.52	1.66	1.69	-	-	6.81	6.19	5.30	2.80	-
			lb-in	31.2	14.7	15.0	-	-	60.3	54.8	46.9	24.8	-
Rated Speed		N _{rtd}	rpm	3000	6000	6000	-	-	2000	3000	4000	6000	-
Rated Power (speed) ①②④⑦		P _{rtd}	kW	1.11	1.04	1.06	-	-	1.43	1.94	2.22	1.76	-
			Hp	1.48	1.40	1.42	-	-	1.91	2.61	2.98	2.36	-

See following page for notes.

AKMA5x Performance Data – Up to 640 Vdc (Continued)

Parameters	Tol	Symbol	Units	AKM51					AKMA52				
				E	G	H	K	L	E	G	H	L	M
Torque Constant ①②	±10%	K_t	Nm/A _{rms}	1.71	0.99	0.80	0.52	0.41	2.79	1.79	1.44	0.75	0.66
			lb-in/A _{rms}	15.2	8.7	7.1	4.6	3.7	24.7	15.8	12.7	6.6	5.8
Back EMF Constant ③	±10%	K_e	V _{rms} /krpm	110.4	63.6	51.3	33.5	26.6	179.4	115.3	92.7	48.3	42.4
Motor Constant ①	Nom	K_m	N-m/√W	0.47	0.48	0.46	0.48	0.48	0.76	0.76	0.76	0.78	0.76
			lb-in/√W	4.13	4.21	4.05	4.29	4.22	6.73	6.73	6.71	6.86	6.72
Resistance (line-line) ④	±10%	R_m	ohm	8.98	2.87	1.97	0.75	0.49	8.96	3.70	2.35	0.61	0.49
Inductance (line-line)		L	mH	36.6	12.1	7.9	3.4	2.1	44.7	18.5	11.9	3.2	2.5
Inertia (includes feedback) ⑤	±10%	J_m	kg-cm ²	3.40					6.20				
			lb-in-s ²	3.0E-03					5.5E-03				
Optional Brake Inertia (additional)	±10%	J_m	kg-cm ²	0.166					0.166				
			lb-in-s ²	1.5E-04					1.5E-04				
Weight ⑥		W	kg	6.4					8.2				
			lb	14.1					18.1				
Static Friction ①		T_f	Nm	0.152					0.170				
			lb-in	1.35					1.50				
Viscous Damping ①		K_{dv}	Nm/krpm	0.03					0.04				
			lb-in/krpm	0.29					0.37				
Thermal Time Constant		TCT	minutes	20					24				
Thermal Resistance		R_{thw-a}	°C/W	0.68					0.56				
Pole Pairs				5					5				
Heat Sink Size				12"x12"x0.5" Aluminum Plate					12"x12"x0.5" Aluminum Plate				

Notes:

- ① Motor winding temperature rise, ΔT=100°C, at 40 °C ambient.
- ② All data referenced to sinusoidal commutation.
- ③ Add holding brake if applicable for total inertia.
- ④ Motor with 125 °C rated feedback and standard heat sink.
- ⑤ May be limited at some values of V_{bus}.
- ⑥ Measured at 25°C.
- ⑦ Brake option reduces continuous torque rating by:
AKMA51 = 0.24 Nm AKMA52 = 0.42 Nm AKMA53 = 0.55 Nm AKMA54 = 0.69 Nm
- ⑧ Brake option increases weight by 2.0 kg (4.4 lb)

*Complete AKMA series model nomenclature can be found on page 9.

AKMA5x Performance Data

AKMA5x Performance Data – Up to 640 Vdc

Parameters	Tol	Symbol	Units	AKMA53					AKMA54				
				H	K	L	M	P	H	K	L	N	P
Max Rated Voltage	Max	V _{bus}	V _{AC}	480	480	480	240	240	480	480	400	240	240
			V _{DC}	640	640	640	320	320	640	640	560	320	320
Continuous Torque (Stall) for ΔT winding = 100°C ①②④⑦	Nom	T _{CS}	Nm	10.79	10.89	10.89	10.69	10.69	13.21	13.41	13.11	13.11	13.41
			lb-in	95.5	96.4	96.4	94.6	94.6	116.9	118.7	116.0	116.0	118.7
Continuous Current (Stall) for ΔT winding = 100°C ①②④⑦	Nom	I _{CS}	A _{rms}	6.29	8.94	11.22	12.80	18.24	5.22	9.08	11.76	16.72	18.53
Continuous Torque (Stall) for ΔT winding = 60°C ②④⑦	Nom	T _{CS}	Nm	8.36	8.44	8.44	8.28	8.28	10.23	10.39	10.15	10.15	10.39
			lb-in	74.0	74.7	74.7	73.3	73.3	90.6	91.9	89.9	89.9	91.9
Max Mechanical Speed ⑤	Nom	N _{max}	rpm	6000	6000	6000	6000	6000	6000	6000	6000	6000	6000
Peak Torque ①②	Nom	T _p	Nm	30.00	30.30	30.30	29.70	29.80	37.50	38.50	37.50	37.60	38.00
			lb-in	265.5	268.2	268.2	262.8	263.7	331.9	340.7	331.9	332.8	336.3
Peak Current	Nom	I _p	A _{rms}	19.8	28.2	35.4	40.7	57.4	16.5	29.2	37.5	53.4	58.8
Rated Torque (speed) ①②④⑦		T _{rtd}	Nm	-	-	9.99	-	-	-	-	-	-	-
			lb-in	-	-	88.4	-	-	-	-	-	-	-
Rated Speed		N _{rtd}	rpm	-	-	1200	-	-	-	-	-	-	-
Rated Power (speed) ①②④⑦		P _{rtd}	kW	-	-	1.26	-	-	-	-	-	-	-
			Hp	-	-	1.68	-	-	-	-	-	-	-
Rated Torque (speed) ①②④⑦		T _{rtd}	Nm	9.79	9.39	8.88	8.01	5.17	12.41	11.71	10.51	8.86	8.24
			lb-in	86.6	83.1	78.6	70.9	45.8	109.8	103.6	93.0	78.4	72.9
Rated Speed		N _{rtd}	rpm	1500	2000	2500	3000	5000	1000	1800	2500	3500	4000
Rated Power (speed) ①②④⑦		P _{rtd}	kW	1.54	1.97	2.32	2.52	2.71	1.30	2.21	2.75	3.25	3.45
			Hp	2.06	2.64	3.12	3.37	3.63	1.74	2.96	3.69	4.35	4.63
Rated Torque (speed) ①②④⑦		T _{rtd}	Nm	8.12	6.94	5.29	-	-	11.61	9.06	7.14	-	-
			lb-in	71.9	61.4	46.8	-	-	102.7	80.2	63.2	-	-
Rated Speed		N _{rtd}	rpm	3000	4000	5000	-	-	1800	3500	4500	-	-
Rated Power (speed) ①②④⑦		P _{rtd}	kW	2.55	2.91	2.77	-	-	2.19	3.32	3.36	-	-
			Hp	3.42	3.90	3.71	-	-	2.93	4.45	4.51	-	-
Rated Torque (speed) ①②④⑦		T _{rtd}	Nm	8.11	6.14	3.34	-	-	11.21	8.26	-	-	-
			lb-in	71.8	54.3	29.6	-	-	99.2	73.1	-	-	-
Rated Speed		N _{rtd}	rpm	3000	4500	6000	-	-	2000	4000	-	-	-
Rated Power (speed) ①②④⑦		P _{rtd}	kW	2.55	2.89	2.10	-	-	2.35	3.46	-	-	-
			Hp	3.42	3.88	2.81	-	-	3.15	4.64	-	-	-

See following page for notes.

AKMA5x Performance Data – Up to 640 Vdc (Continued)

Parameters	Tol	Symbol	Units	AKM53					AKMA54				
				H	K	L	M	P	H	K	L	N	P
Torque Constant ①②	±10%	K_t	Nm/A _{rms}	1.75	1.24	0.99	0.85	0.60	2.57	1.50	1.13	0.80	0.74
			lb-in/A _{rms}	15.4	11.0	8.7	7.5	5.3	22.8	13.3	10.0	7.1	6.5
Back EMF Constant ③	±10%	K_e	V _{rms} /krpm	112.4	79.8	63.6	54.7	38.4	165.6	96.6	72.9	51.3	47.3
Motor Constant ①	Nom	K_m	N-m/√W	0.98	0.98	0.96	0.96	0.93	1.17	1.18	1.13	1.12	1.14
			lb-in/√W	8.70	8.70	8.49	8.50	8.20	10.39	10.43	10.03	9.91	10.10
Resistance (line-line) ④	±10%	R_m	ohm	2.10	1.06	0.69	0.51	0.27	3.20	1.08	0.65	0.33	0.27
Inductance (line-line)		L	mH	11.4	5.7	3.6	2.7	1.3	18.3	6.2	3.5	1.8	1.5
Inertia (includes feedback) ⑤	±10%	J_m	kg-cm ²	9.10					12.00				
			lb-in-s ²	8.1E-03					1.1E-02				
Optional Brake Inertia (additional)	±10%	J_m	kg-cm ²	0.166					0.166				
			lb-in-s ²	1.5E-04					1.5E-04				
Weight ⑥		W	kg	10.0					11.8				
			lb	22.0					26.0				
Static Friction ①		T_f	Nm	0.19					0.21				
			lb-in	1.66					1.83				
Viscous Damping ①		K_{dv}	Nm/krpm	0.052					0.061				
			lb-in/krpm	0.46					0.54				
Thermal Time Constant		TCT	minutes	28					31				
Thermal Resistance		R_{thw-a}	°C/W	0.50					0.45				
Pole Pairs				5					5				
Heat Sink Size				12"x12"x0.5" Aluminum Plate					12"x12"x0.5" Aluminum Plate				

Notes:

- ① Motor winding temperature rise, ΔT=100°C, at 40 °C ambient.
- ② All data referenced to sinusoidal commutation.
- ③ Add holding brake if applicable for total inertia.
- ④ Motor with 125 °C rated feedback and standard heat sink.
- ⑤ May be limited at some values of V_{bus}.
- ⑥ Measured at 25°C.
- ⑦ Brake option reduces continuous torque rating by:
 AKMA51 = 0.24 Nm AKMA52 = 0.42 Nm AKMA53 = 0.55 Nm AKMA54 = 0.69 Nm
- ⑧ Brake option increases weight by 2.0 kg (4.4 lb)

*Complete AKMA series model nomenclature can be found on page 9.

AKMA5x Dimensional Data

AKMA 5 2 C - GN D N CA 1 K*
 Motor Series Frame Size Stack Length Winding Mount/Shaft Connection Brake Feedback Thermal Sensor Seal

AKMA5x Frame

Flange Mount

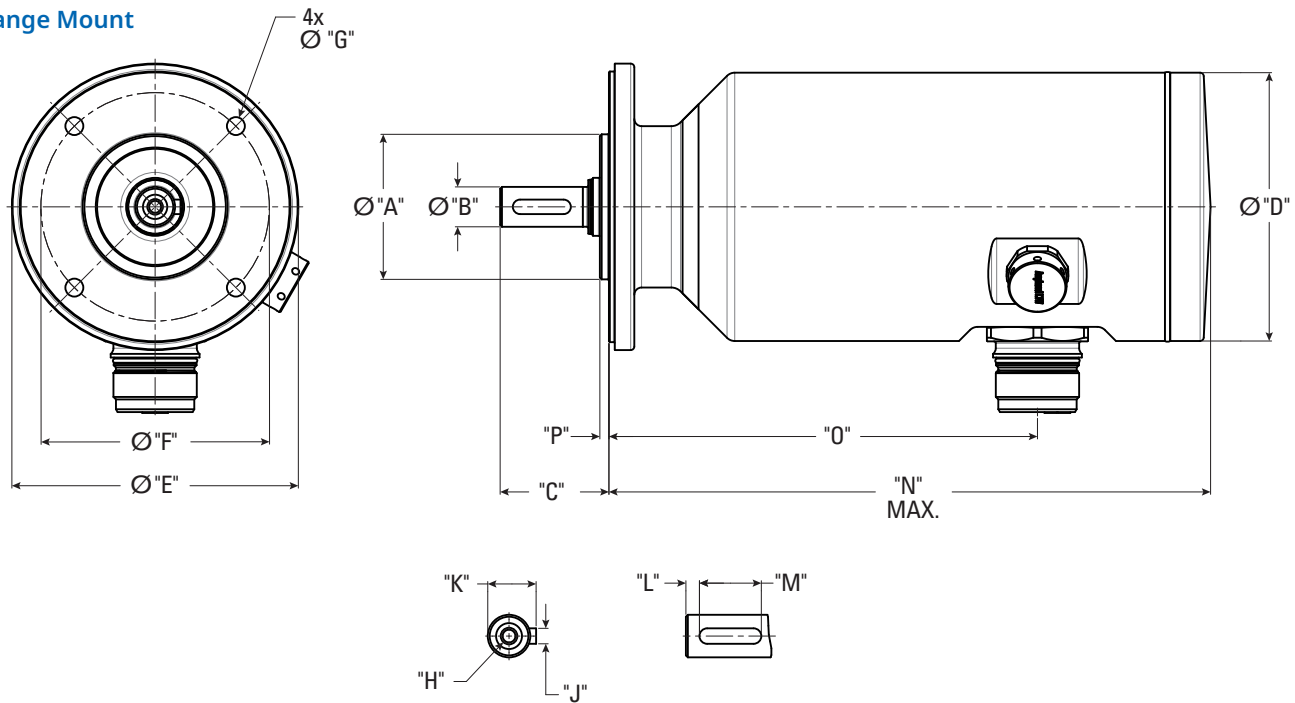

AKMA5x Dimension Data

Code	Shaft	Pilot Dia. "A"	Shaft Dia. "B"	Shaft Length "C"	Motor Body Dia. "D"	Flange Dia. "E"	Bolt Circle Dia. "F"	Bolt Hole Dia. "G"
GC	Keyway	Ø95j6	Ø24k6	50	132	137	115	9+0.36/-0.0
GN	Smooth	Ø95j6	Ø24k6	50	132	137	115	9+0.36/-0.0

Code	"H"	Key Height "J"	Key Width "K"	"L"	Key Length "M"	Pilot Height "P"
GC	M8 DIN332	27 +0/-0.13	8N9	4	36 +0/-0.30	3.0
GN	M8 DIN332	-	-	-	-	3.0

MODEL	Connector Position "O"		Motor Length "N"	
	W/O Brake	W/ Brake	W/O Brake	W/ Brake
AKMA51	138.1	188.3	186.3	236.9
AKMA52	169.1	219.3	217.3	267.9
AKMA53	200.1	250.3	248.3	298.9
AKMA54	231.1	281.3	279.3	329.9

Dimensions are in mm.

*Complete AKMA series model nomenclature can be found on page 9.

Notes

AKMA 5 2 E - GN D N CA 1 K*
Motor Series Frame Size Stack Length Winding Mount/Shaft Connection Brake Feedback Thermal Sensor Seal

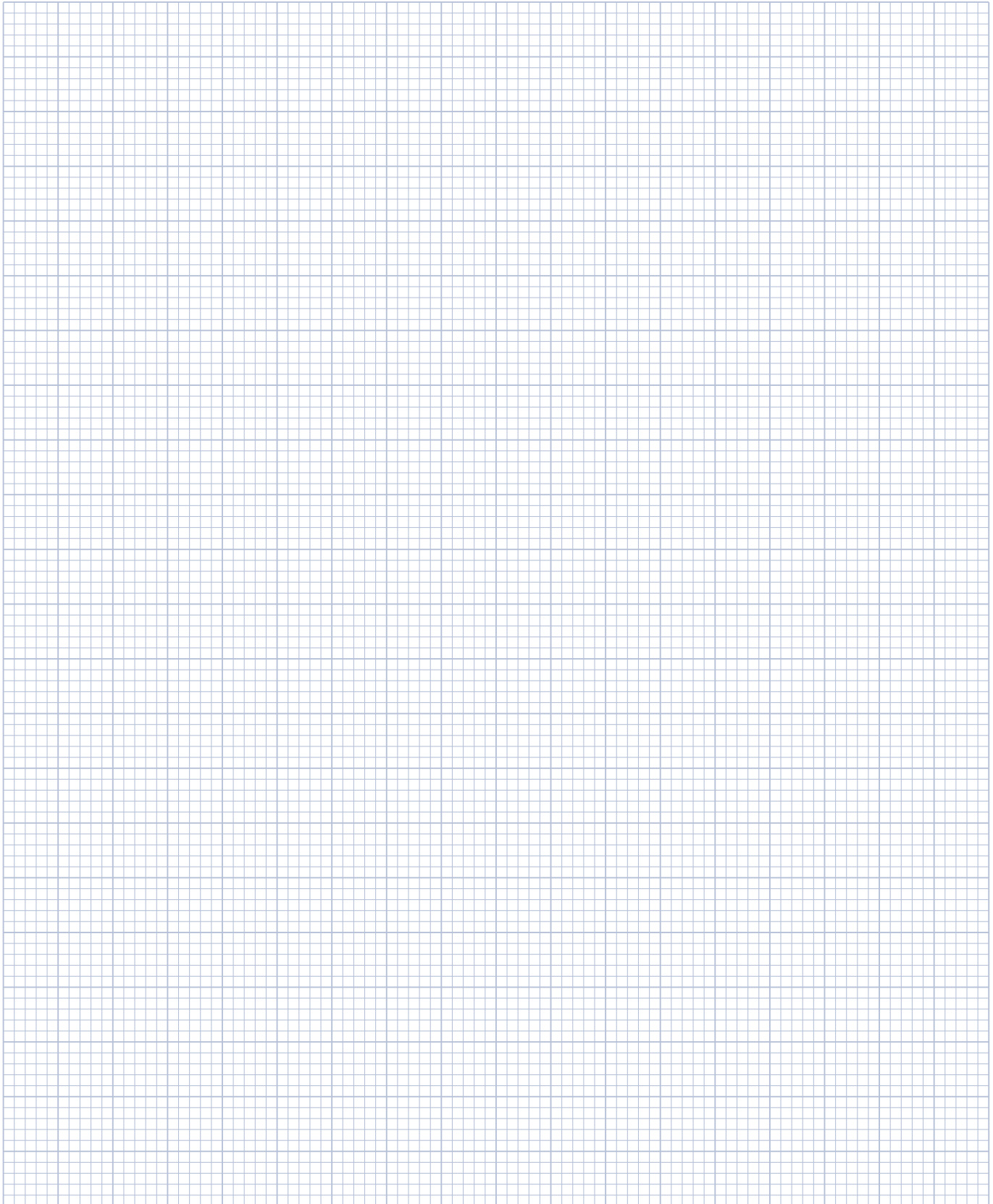

2 mm divisions

*Complete AKMA series model nomenclature can be found on page 9.

Brake & Feedback Options

Holding Brake

The holding brake is designed to provide motor shaft static holding torque with the brake coil de-energized. The brake must first be released (coil energized) prior to commanding motion as determined by its drop-out time. The optional brake is intended for stationary motor holding, or “parking,” and is NOT intended for dynamic braking (i.e. There should be absolutely no intended rotor motion when power is removed from the brake coil to physically engage brake.)

AKMA Motor Brake Specifications

Motor	Minimum Static Torque @120°C		Power Consumption @24V, 20°C	Current @24V, 20°C	Inertia		Closing Time (engage)	Opening Time (release)	Backlash	
	Nm	lb-in			kg-cm ²	lb-in-sec ²			Maximum	Typical
			Watts ±7%	ADC			msec	msec	deg.	deg.
AKMA2	1.42	12.6	8.4	0.35	0.0128	1.81E-04	36	35	1.01	0.46
AKMA3	2.5	22.1	10.1	0.42	0.0135	1.91E-04	20	50	1.01	0.46
AKMA4	5.3	46.9	12.8	0.53	0.0579	8.20E-04	30	75	0.81	0.37
AKMA5	14.5	128	19.5	0.82	0.1658	2.35E-03	30	115	0.71	0.31

Note 1: Operating Voltage: 24 Vdc ± 10%.

Note 2: Maximum backlash is calculated using worst-case tolerancing, and typical backlash is calculated using statistical tolerancing.

Feedback Options

The AKMA motor is available with one of the three following feedback options and utilizes hybrid (power+brake+feedback) single-cable drive connectivity. A thermal sensor is connected to the encoder and temperature information is transferred over the communication protocol.

AKMA Feedback Option Specifications

Feedback	Description	Feedback Model	Technology	Single-turn resolution	Multi-turn resolution	Accuracy ±arc-min
CA	Smart Feedback Device	SFD3	Resolver	24 bits	---	8
GU	Hiperface DSL encoder	EEM37	Capacitive	17 bits	12 bits (4096)	4
LD	EnDat 2.2 inductive encoder	EQI1131 (AKMA2-5)	Inductive	19 bits	12 bits (4096)	2

AKMA Motor Connector Pinouts

AKMAxx D- Connector Pinout

D- with SFD3 (CA)

AKMA x x x - xx **D 2 CA** x x
 |
 Connection
 |
 Brake
 |
 Feedback

Power ± Brake + SFD3/DSL

Function	AKMA M23
Phase U	U
Phase V	V
Phase W	W
PE	⊕
Brake +	A
N/C	B
N/C	C
Brake -	D
SFD3/DSL+	1
SFD3/DSL-	2

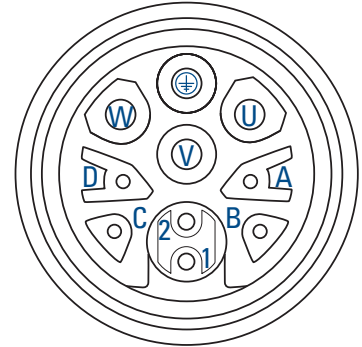

D- with HIPERFACE DSL (GU)

AKMA x x x - xx **D 2 GU** x x

Power ± Brake + EnDAT 2.2

Function	AKMA M23
Phase U	U
Phase V	V
Phase W	W
PE	⊕
Brake +	A
N/C	B
N/C	C
Brake -	D
S+ Up	1
S- 0 V	2
Data+	3
Data-	4
Clock+	5
Clock-	6

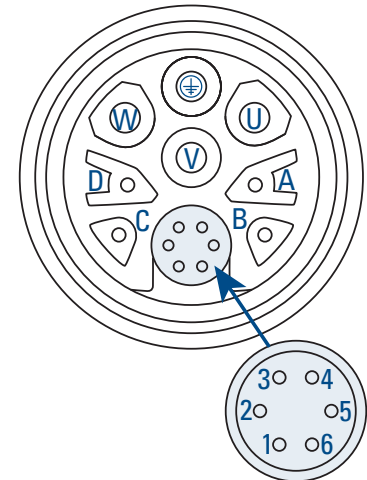

AKMA Motor Cables

H2 - 21 - 015 - W1 - 00 - XXXX00
 Cable Version Drive Connector Wire X-section Motor Mating Connector Customization Length

AKMA Cable Properties

Test voltage	3kVAC
Operating voltage	1000 VAC
Temperature range	-40°C/+90°C static/dynamic/storage
Minimum bending radius - static	5xDia
Minimum bending radius - dynamic	8xDia
Max. speed	300m/min
Max. acceleration	50m/s ²
Max. torsion	30°/m
Max. number of cycles	5,000,000
Flame resistance	EN50265-1-2/IEC60332-1-2/UL VW-1/ CSA FT1
Halogen free	EN50267-2-1/IEC60754-1
Hydrocarbons and oil resistance	UL1581/VDE0472 part 803 A/B

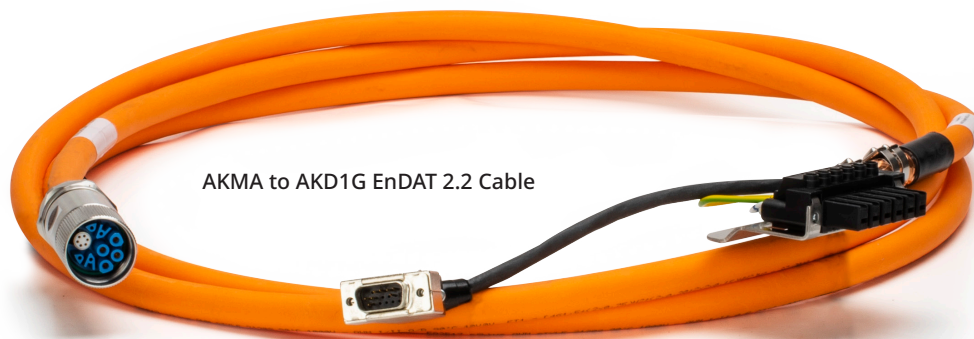

H2 - 21 - 015 - W1 - 00 - XXXX00

Cable Version
 Drive Connector
 Wire X-section
 Motor Mating Connector
 Customization
 Length

AKMAxx Motor to AKD®2G Servo Drive Cables

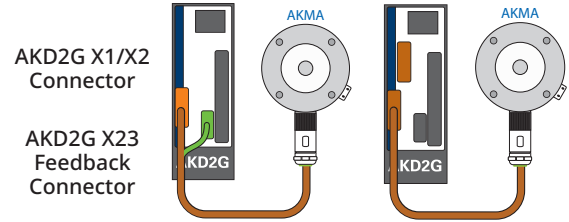

Voltage (V _{AC})	Drive	Motor Feedback	Motor Connector	Current Rating* (A)	Hybrid Cable
120-240	AKD2G-SPx-6V03x	SFD3 (CA) HIPERFACE DSL (GU)	Single straight IP69K	Rms < 11	H2-21-010-W1-00-XXXX00
	AKD2G-SPx-6V06x			Rms < 15	H2-21-015-W1-00-XXXX00
	AKD2G-SPx-6V12x				
AKD2G-SPx-7V03x					
AKD2G-SPx-7V06x					
240-480	AKD2G-SPx-7V12x			Rms < 20	H2-21-025-W1-00-XXXX00
	AKD2G-SPx-7V24x	Rms < 27	Contact Kollmorgen Support		
	AKD2G-SPx-6V03x	EnDat 2.2 (LD)	Single straight IP69K	Rms < 15	H2-21-015-W6-00-XXXX00
AKD2G-SPx-6V06x					
AKD2G-SPx-6V12x					
120-240	AKD2G-SPx-7V03x			Rms < 20	H2-21-025-W6-00-XXXX00
	AKD2G-SPx-7V06x				
	AKD2G-SPx-7V12x				
240-480	AKD2G-SPx-7V24x	Rms < 27	Contact Kollmorgen Support		

* Current ratings used on a IEC 60364-5-52 standard

AKD®2G Servo Drive Cable Pinouts

Power ± Brake + SFD3/DSL

AKD2G X1/X2	Function	AKMA M23
1	Phase U	U
2	Phase V	V
3	Phase W	W
Retention Latch, Shield Screw		
5	PE	⊕
B+	Brake +	A
B-	Brake -	D
F+	SFD3/DSL+	1
F-	SFD3/DSL-	2

Power ± Brake

AKD2G X1/X2	Function	AKMA M23
1	Phase U	U
2	Phase V	V
3	Phase W	W
Retention Latch, Shield Screw		
5	PE	⊕
B+	Brake +	A
B-	Brake -	D
F+	-	-
F-	-	-

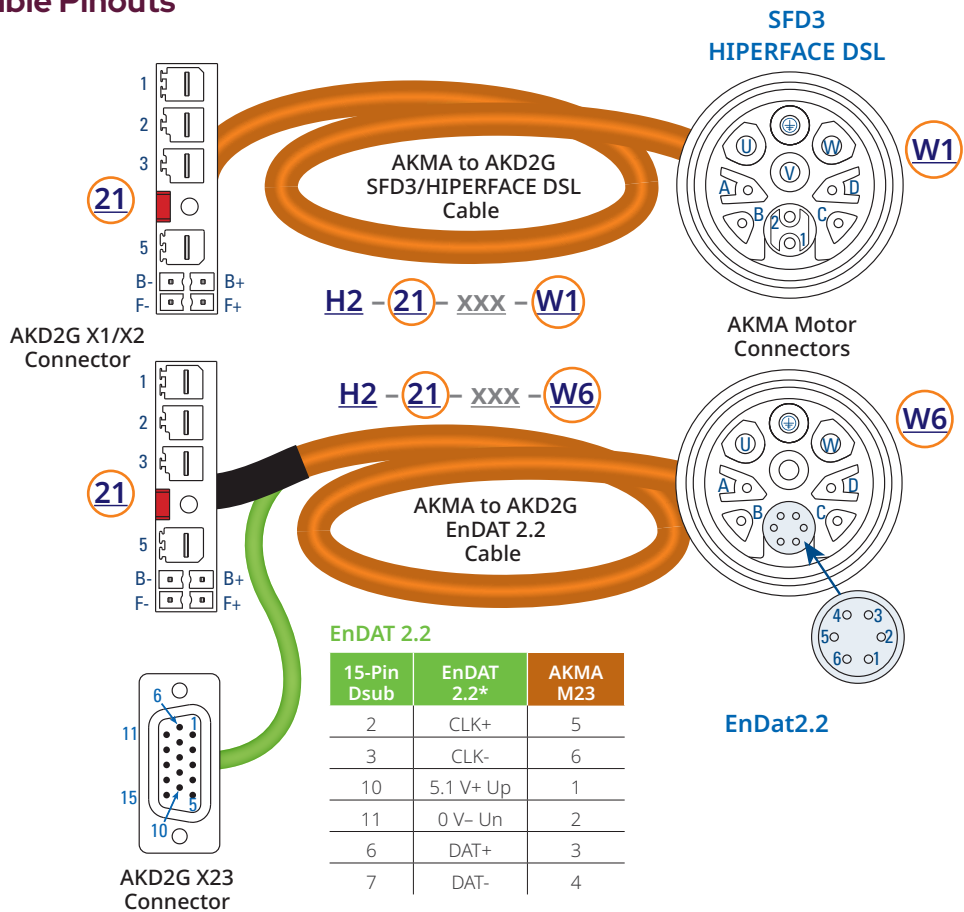

AKMA Motor Cables

H2 - 21 - 015 - W1 - 00 - XXXX00
 Cable Version Drive Connector Wire X-section Motor Mating Connector Customization Length

AKMAxx Motor to AKD® Servo Drive Cables

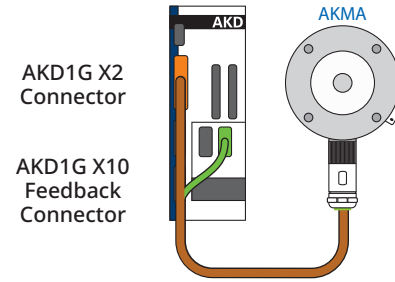

Voltage (V _{AC})	Drive	Motor Feedback	Motor Connector	Current Rating ¹ (A)	Hybrid Cable
120-240	AKD-x00306 AKD-x00606 AKD-x01206 AKD-x02406	SFD3 (CA) HIPERFACE DSL (GU)	Single straight IP69K	Rms < 11	H2-11-010-W1-00-XXXX00
				Rms < 15	H2-11-015-W1-00-XXXX00
				Rms < 15	H2-12-015-W1-00-XXXX00
				Rms < 20	H2-12-025-W1-00-XXXX00
				Rms < 27	H2-12-040-W1-00-XXXX00
240-480	AKD-x00307 AKD-x01207 AKD-x02407			Rms < 15	H2-12-015-W1-00-XXXX00
				Rms < 20	H2-12-025-W1-00-XXXX00
				Rms < 27	H2-12-040-W1-00-XXXX00
120-240	AKD-x00306 AKD-x00606 AKD-x01206 AKD-x02406	EnDAT 2.2 (LD)	Single straight IP69K	Rms < 15	H2-14-015-W6-00-XXXX00
				Rms < 15	H2-15-015-W6-00-XXXX00
				Rms < 20	H2-15-025-W6-00-XXXX00
				Rms < 27	H2-15-040-W6-00-XXXX00
				Rms < 15	H2-15-015-W6-00-XXXX00
240-480	AKD-x00307 AKD-x01207 AKD-x02407			Rms < 15	H2-15-015-W6-00-XXXX00
				Rms < 20	H2-15-025-W6-00-XXXX00
				Rms < 27	H2-15-040-W6-00-XXXX00

AKD® Servo Drive Cable Pinouts

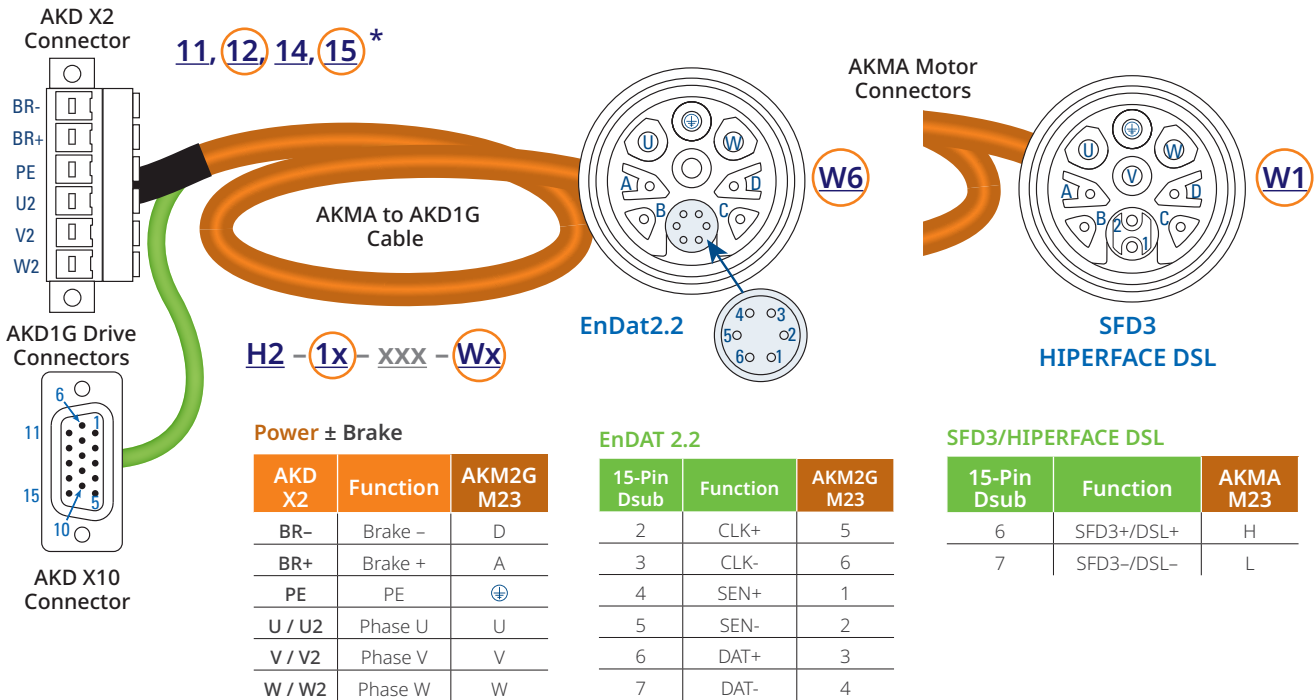

* Connector designation depends on the drive model. Please refer to the cable nomenclature on the following page for more information.

Kollmorgen 2G Cable Nomenclature

H2 - 12 - 015 - A1 - 00 - XXXX00

Cable Version

Cable Jacket Material - PUR

- F1 Mid-flex Feedback Cable PUR
- H2 Mid-flex Hybrid PUR with brake
- P1 Power Cable PUR
- P2 Power Cable PUR with brake

Cable Jacket Material - PVC

- F5 Mid-flex Feedback Cable PVC
- H6 Mid-flex Hybrid PVC with brake
- P5 Mid-flex Power Cable PVC
- P6 Mid-flex Power Cable PVC with brake

Connector Type

If Feedback, connector type [connector type and pinout]

- 10 AKD, AKD2G, 15 Pin D-Sub, 45° angle, Resolver
- 12 AKD, AKD2G, 15 Pin D-Sub, 45 degree angle, EnDat[®] 2.1, BiSS B
- 14 AKD, AKD2G, 15 Pin D-sub, 45 degree angle, HIPERFACE[®]
- 18 AKD, AKD2G, 15 Pin D-sub, 45 degree angle, SFDG2
- 20 AKD, AKD2G, 15 Pin D-sub, 45 degree angle, Comcoder, Sine Enc. w/ Halls
- 41 S300/S700 Resolver 9 pin D-sub
- 42 S300/S700 Encoder 15 pin D-sub (EnDat[®] 2.2, Biss C)
- 43 S300/S700 Encoder 15 pin D-sub (Sine Encoder w Halls)
- 91 Flying leads, Resolver
- 92 Flying leads, EnDat, Biss
- 93 Flying leads, HIPERFACE
- 94 Flying leads, SFD2G
- 95 Flying leads, Comcoder

If Power or Hybrid drive connector type

- 11 AKD-x00306, -x00606 (Power and Hybrids with HDSL, SFD3)
- 12 AKD-x01206, -x02406 (Power and Hybrids with HDSL, SFD3)
- AKD-x00307, -x00607, -x01207, -x02407 (Power and Hybrids with HDSL, SFD3)
- 13 AKD-x04807 (Power and Hybrids with HDSL, SFD3)
- 14 AKD-x00306, -x00606 (Hybrids with EnDat 2.2)
- 15 AKD-x01206, -x02406 (Hybrids with EnDat 2.2)
- AKD-x00307, -x00607, -x01207, -x02407 (Hybrids with EnDat 2.2)
- 21 AKD2G-x00306, -x00606, -x01206
- AKD2G-x00307, -x00607, -x01207, -x02406, -x02407
- 33 AKD-N DB (Hybrid cable)
- 34 AKD-N DF/DS (Power cable)
- 41 S300 MV (Power or Hybrid w/ SFDG3, DSL)
- 42 S300 HV (Power or Hybrid w/ SFDG3, DSL)
- 43 S300 MV (Hybrid with EnDat 2.2-22)
- 44 S300 HV (Hybrid with EnDat 2.2-22)
- 46 S701-S724 connector (Power or Hybrid w/ SFDG3, HDSL)
- 47 S701-S724 connector (Hybrid with EnDat 2.2-22)
- 48 S748/S772 flying leads
- 01 Unterminated flying leads
- SP Special

Length (no less than 100 mm increments)

xxxx00 Length in mm
Standard lengths: 1 - 25 m
Example:
6 m cable = 006000
25 m cable = 025000

Options

- 00 Standard Option Set
- VL Value Line
- XX Specials (excluding standard option set)

Motor Mating Connector Type

Hybrid / Power Connectors (#Pins)

- A1 AKM2G, M23 SpeedTec[®] (9)
- A4 AKM2G, M40 SpeedTec (9)
- A5 AKM1G, M23 SpeedTec (8)
- A6 AKM1G, M23 Screw-type (8)
- A7 AKM1G, M40 SpeedTec (6)
- B1 AKM2G, M23 htec (9) (standard keying, DSL)
- B2 AKM2G, M23 htec (13) (rotated keying, EnDat 2.2)
- B3 AKM2G, M40 htec (11) (standard keying, DSL)
- C1 AKM/AKM2G, M15 ytec[®] (9)
- C4 AKM, M15 itec (9) (SFD3)
- UB Unterminated (Blunt Cut)
- UF Unterminated (Flying leads)
- W1 AKMA, M23 SS Screw-type Washdown (8) (SFD3/DSL)
- W5 AKM, M23 Hummel Washdown (8)
- W6 AKMA, M23 SS Screw-type Washdown (12) (EnDat 2.2)

Feedback Connectors

- A2 AKM/AKM2G, M23 SpeedTec (12)
- A3 AKM/AKM2G, M23 SpeedTec (17)
- C2 AKM/AKM2G, M15 ytec (12)
- C3 AKM/AKM2G, M15 ytec (15)
- UB Unterminated (Blunt cut)
- UF Unterminated (flying leads)
- W2 AKM, M23 Hummel Washdown (12)

Cable Type

If Feedback, type [cable construction, not pinout]

- FB1 4 Conductor
- FB2 8 Conductor
- FB3 6 Conductor
- FB4 16 Conductor
- FB5 14 Conductor
- FB6 10 Conductor
- FB7 12 Conductor

If Power or Hybrid drive connector type

- 010 1.0 mm²
- 015 1.5 mm²
- 025 2.5 mm²
- 040 4.0 mm²
- 060 6.0 mm²
- 100 10.0 mm²

I. General Technical Data

Ambient Temperature: 0...+25° C for site altitude up to 1000 m amsl (at rated values). It is vital to consult our applications department for ambient temperatures above 40° C and/or any enclosed environment.

Power De-rating (currents and torques): 1% / °C in range 40° C...50° C up to 1000 m amsl for site altitude above 1000 m amsl and 40° C

- » 6% up to 2000 m amsl
- » 17% up to 3000 m amsl
- » 30% up to 4000 m amsl
- » 55% up to 5000 m amsl

For site altitudes above 1000 m amsl, no de-rating with temperature reduction of 10° C / 1000 m

Temperature De-rating: If the application requires de-rating due to lower motor surface temperature, please contact our applications department.

Ball-bearing Life: ≥ 20,000 operating hours

II. L10 Bearing Fatigue

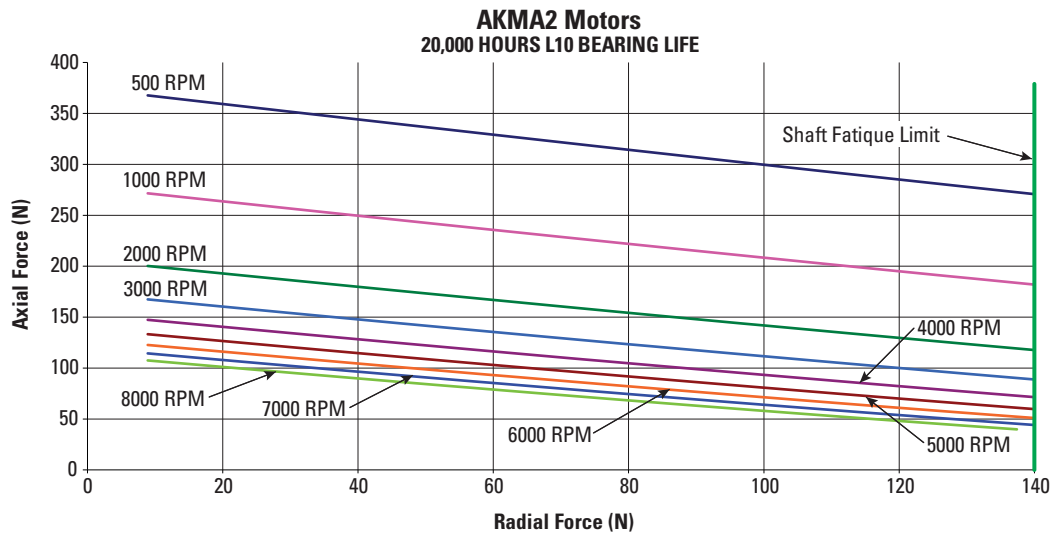

Continued on next page.

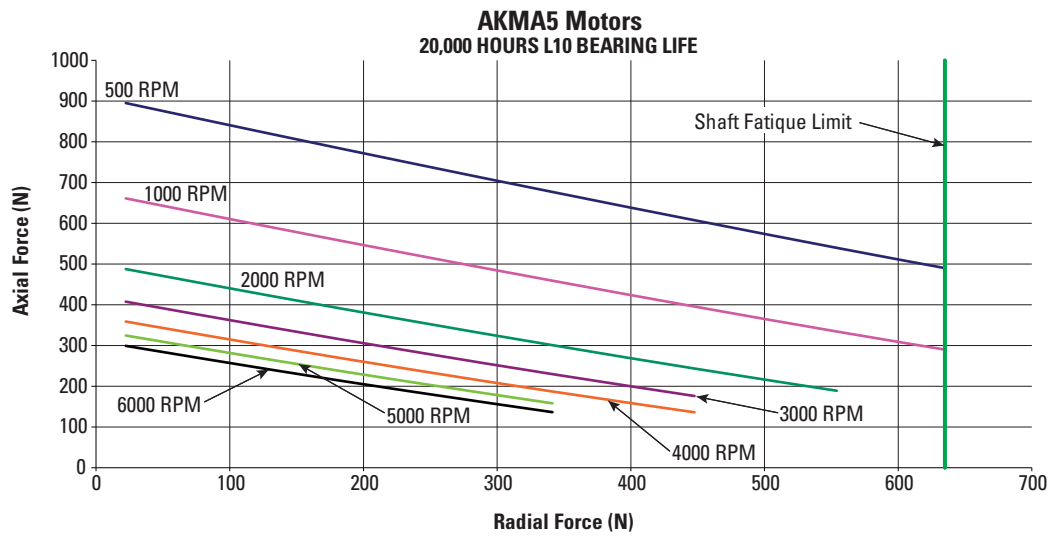
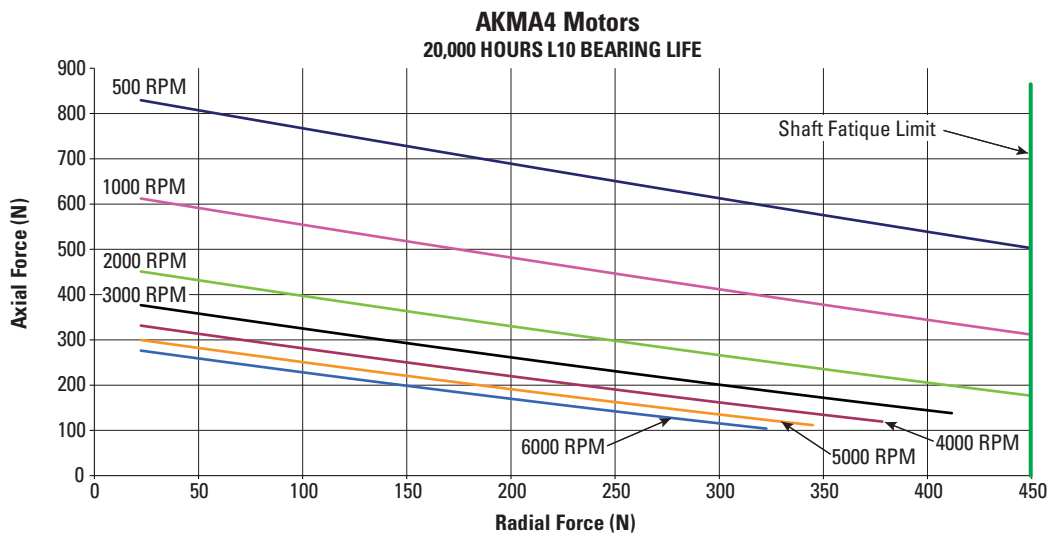
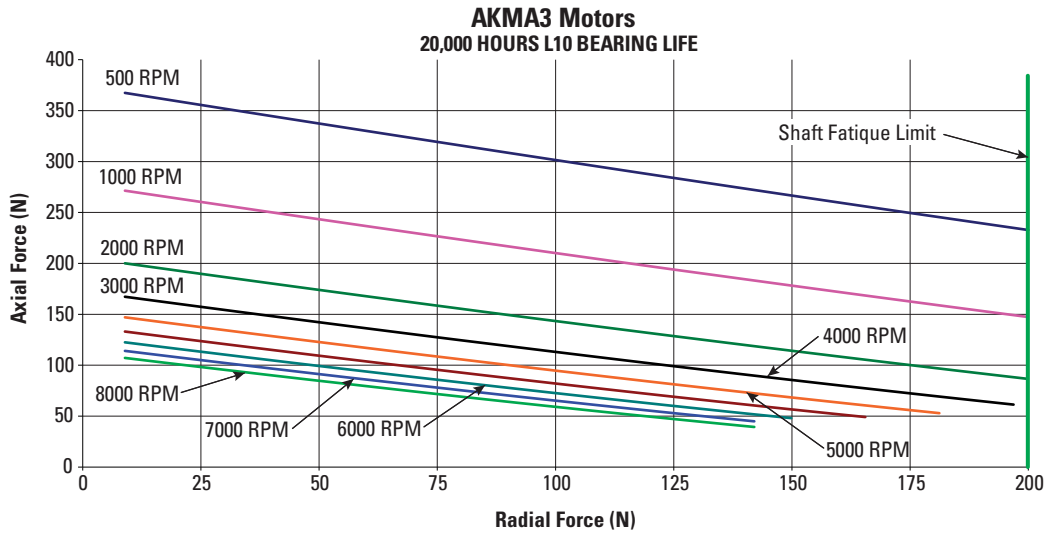

III. Shaft Loading

Motor	Max. Radial Force (N)	Max. Axial Force (N)
AKMA2xy-A	140	600
AKMA3xy-A	200	600
AKMA4xy-A	450	1400
AKMA5xy-G	635	1740

The maximum radial load ratings reflect the following assumptions:

1. Motors are operated with peak torque of the longest stack length of the frame size.
2. Constant radial load on the end of the shaft for the smallest OD and longest standard shaft extension.
3. Infinite life with 99% reliability.
4. Safety factor = 2.

IV. Phasing Diagram - All Motors

- When the motor is rotated C.W. (viewed from drive shaft end), the following BEMF voltage waveforms result:
- Voltage phase-U, leads Voltage phase-V, by 120-degrees
- Voltage phase-V, leads Voltage phase-W, by 120-degrees
- Voltage phase-W, leads Voltage phase-U, by 120-degrees

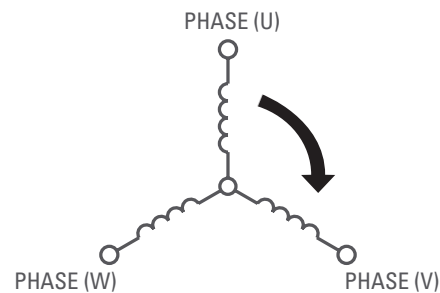

Motor Winding Configuration

V. Protection Class

Shaft Seal	Flange Sealing	Protection Class
PTFE	O-Ring: EPDM (K) or Viton (V)	IP69K

Protection class IP69K has been created for high pressure and high temperature cleaning according to DIN 40050-9. Code "6" (Dust tight. No ingress of dust.) defines the protection against solids. Code "9K" (Protected against close-range high pressure, high temperature spray downs.) defines the protection against liquids.

IP69K protection class is for static use only. This rating does not account for water present while the shaft is rotating. For applications that require sealing during rotation, please contact Kollmorgen Customer Support.

VI. Insulation Material

AKMA motors are insulation class F according to IEC 60085 (UL1446 class F).

VII. Surface

The AKMA motor housing is made from anodized 6082 aluminum.

IX. Protective Device

AKMA motors are fitted with an electrically isolated temperature sensor (rated temperature $155^{\circ}\text{C} \pm 5\%$) and integrate into the motor temperature monitoring system (e.g. Kollmorgen's AKD). The standard motor option is equipped with a PT1000 thermal sensor; with a threshold limit setting of 1592 Ohms.

The standard sensor option is defined by following diagram:

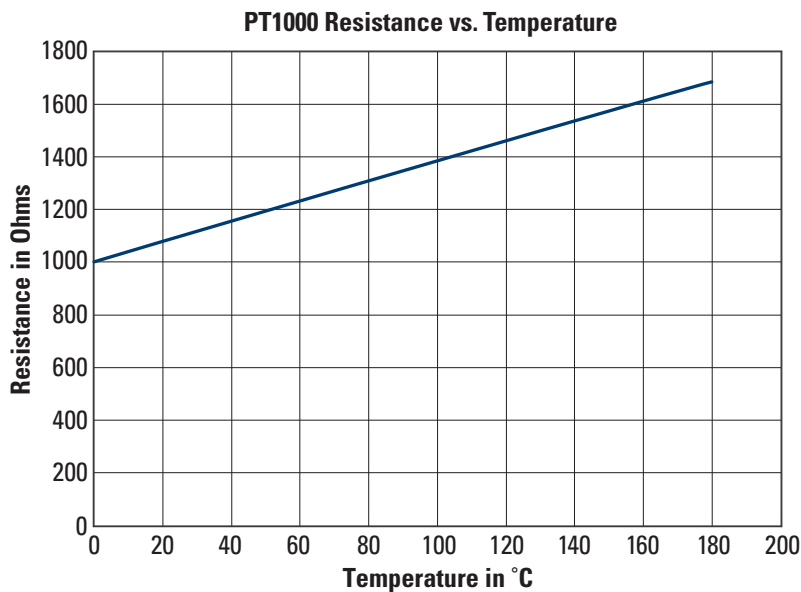

Please note, these protection devices are for monitoring and protecting the motor during normal operation and when attempting to maximize operation—they should not be expected to provide protection against a short or other overload event.

IX. Vibration Class

Velocity [rpm]	Max. Rel. Vibration Displacement [μm]	Max. Run-out [μm]
≤ 1800	90	23
> 1800	65	16

AKMA motors are designed and manufactured to meet vibration class A (EN 60034-14). Hence, a defined speed range of 600 to 3600 rpm, with a frame size between 56 and 132 mm, means the permitted vibration is 1.6 mm/s.

AKMA™ Hygienic Design Guide

I. Hygienic Design

The Food and Drug Administration (FDA) is an agency of the United States Department of Health and Human Services. The FDA is responsible for protecting and promoting public health through the regulation and supervision of food safety, vaccines, biopharmaceuticals, blood transfusions, medical devices and other products.

The “European Hygienic Engineering and Design Group” (EHEDG) is a European-based non-government organization devoted to the advancement of hygienic design and food engineering. European legislation requires that handling, preparation, processing, packaging, etc. of food is done hygienically, with hygienic machinery in hygienic premises (the food hygiene directive, the machine directive and the food contact materials directive).

Certifications: UL, CE, RoHs, UKCA

Surface: 6082 Aluminum Anodized; satin gray

Immunity: Against tested industrial cleaning agent, corrosion-proof

Degree of Protection: IP69K

Mounting Screw*: Stainless steel 316L/1.4404, sealant FDA 21 CFR 175.300

O-Ring: EPDM or Viton, FDA 21 CFR 177.2600

Shaft: Stainless steel 316L/1.4404

Rotary Shaft Seal: Mineral filled PTFE, single lip, mineral: FDA 21 CFR 175.300, PTFE: FDA 21 CFR 177.1500

Bearing Grease: Food-grade as per FDA 21 CFR 178.3570

Connector with Viton Seal: Stainless steel 1.4404, Silicone seal FDA 21 CFR 177.2600

Name Plate: Laser marked in housing

Size: AKMA2 to AKMA5

*Optional, included in the mounting kit

Universal Drive Solutions for Food, Beverage, and Pharmaceutical Industries

Motors from Kollmorgen provide the perfect mix of performance and hygiene

The Kollmorgen modular system includes a wide range of motors with carefully graduated performance data, a variety of connection options, and feedback devices. With more than 500,000 standard motor designs, you will definitely find a suitable motor to meet your requirements. Meeting the strict legal regulations and the customers' requests for innovative yet cost-effective drive solutions always poses a challenge to the mechanical engineer. Drive solutions from Kollmorgen provide the perfect mix of hygiene and performance data for applications in normal and difficult operating environments, as well as for hygienic drives. Kollmorgen has invested more than 50 years of experience in the AKM2G, AKM, AKM Washdown, AKM Washdown Food and AKMH stainless steel motor ranges that prove themselves on a daily basis in the testing conditions of the food, beverage, and pharmaceutical industries.



	AKM	AKM Washdown	AKM Food Grade	AKMA	AKMH
Housing Material & Coating	Square-frame A380 Aluminum polyester powder coating; matte black	Square-frame A380 Aluminum 2K epoxy paint; gray	Square-frame A380 Aluminum 2K epoxy FDA-compliant paint; white	Round-frame 6082 Aluminum Anodized; satin gray	Round-frame 1.4404/316 Stainless steel; Surface roughness < 0.8 µm per EHEDG requirement
Mounting Style	Flange	Flange	Flange	Flange	Flange or Face
Ingress Protection (IP)	IP65 (static); w/shaft seal	IP67 (static)	IP67 (static)	IP69K (static)	IP69K (static)
IP Rating Definition	6 = Dust-tight				
	5 = Water jets (7 is possible w/ straight conn.)	7 = Immersion up to 1m, for 30 min.		9K = High-pressure/High-temp	
Shaft Seal	1 = Teflon shaft seal	0W = includes Teflon shaft seal	0F = includes IP67 Food-Grade PTFE shaft seal	IP69K Food-Grade PTFE shaft seal	IP69K Food-Grade PTFE shaft seal
Typical Connectors	Nickel-plated TE/ Interconnect Connectors	SS Hummel Connectors (unpainted)	SS Hummel Connectors (unpainted)	IP69K SS Motor-mounted Hummel Connectors	IP69K integrated motor cable; optional IP69K SS Motor-mounted Hummel Connectors
Application Examples	<ul style="list-style-type: none"> General factory automation where exposure to contaminants (i.e. fluids, oil, dust) is possible 	<ul style="list-style-type: none"> Food and beverage Packaging (i.e. transport axes with no direct contact to food) General factory automation (i.e. similar applications to AKM with added protection and longevity) 	<ul style="list-style-type: none"> Food and beverage Packaging Cutting Packing and filling where direct contact to food is possible (motor positioned laterally or below food) 	<ul style="list-style-type: none"> Food and beverage (i.e. meat slicing, proportioning, dispensing applications where direct contact to food is likely) Pharmaceutical production Medical laboratories Radar stations Harsh outdoor applications 	<ul style="list-style-type: none"> Food and beverage (including food contact and splash zones) Packaging Machine applications requiring heavy sanitization or exclusive use of stainless components (i.e. use of highly acidic, caustic chemicals) Pharmaceutical production Medical laboratories
Relative Price	\$	\$+	\$++	\$\$	\$\$\$

AKMA™ Co-Engineered Solutions

With modified and custom AKMA solutions, you can rely on decades of Kollmorgen expertise to solve your motion challenges and help your machine stand out from the crowd.



Modified Standard

Because our application expertise runs deep and our product portfolio is so broad, we can take any standard product and modify to different degrees to suit your specific needs – without significant sacrifice of lead time or cost. This approach ensures quality, performance and reliability by leveraging our proven track record.

Kollmorgen application engineers have a great deal of experience helping OEM engineers achieve their objectives. Typical motor modifications include: shaft, housing, winding, feedback type, mounting and connectors.

Project Management

We follow a structured development process from initial concept to volume production. This enables us to provide a complete solution from design to implementation.

Our skilled engineering team is assigned to each project and ensures a high quality product designed and delivered on time, successfully taking the prototype to full production.

- Dedicated Resources & Equipment
- Real Time Customer Collaboration
- Validation of Performance, Cost & Manufacturability Before Volume Production

Customer Visibility Throughout the Entire Process

A communicative and proactive approach keeps you updated and aware of what is required throughout, what it will cost, and what to expect for design testing.

This not only puts you in charge of approving any modifications before installation, but ensures the product is up and running quickly, with minimal development time and maximum value.

Engineering Excellence

What really sets us apart is our engineering expertise. With over 50 years of successfully designing custom motors, we are able to quickly assess, design and implement a solution that meets your needs.

Our engineering team has decades of experience in motor design, which means they have designed solutions for almost every unique and challenging situation. Their insightfulness and expertise will guide you through the development and implementation of an optimized motor solution.

We rely on the most advanced simulation tools to deliver the best products, designed to withstand the most unique and challenging environments.

Why You Should Partner with Kollmorgen

- Experienced application engineers help define a customer's needs and identify the optimal Kollmorgen products and technologies
- Products optimized or developed by cross-functional teams to meet customer needs
- Rapid prototyping
- Smooth transition from prototype designs to sustainable and cost effective manufacturing
- Industry-proven quality, performance, and delivery
- Proven technology building blocks mitigate risks of customization

Contact Kollmorgen Customer Support today to discuss our design capabilities for a modified and co-engineered AKMA solution to meet your specific needs.

Complete Motion and Automation Solutions

The highest performance and the right fit for any application.



Online Design Tools

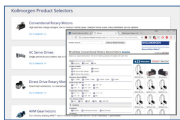

Product Selector
Quickly choose the ideal products for your application needs.



Motioneering®
Size your motion system based on application requirements and motion profiles.

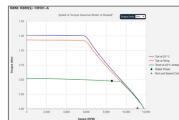

Performance Curve Generator
Optimize housed and frameless motor windings based on power and environmental factors.



3D Models
Visualize products in 3D and download CAD files for use in your design.

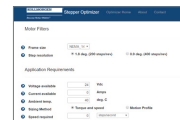

Stepper Optimizer
Interactively choose the most efficient stepper solution for your application.



AKD2G Safe Dynamic Brake Calculator
Specify and size the right braking components while saving development time.



Learn more and try our design tools now.

More Expertise for a More Successful Machine

Our global engineering, service and support network provides deep knowledge of all the major industries that rely on advanced motion control and automation technology. We offer world-class engineering expertise, self-service design tools, personalized field service, and easy access to our design, application and manufacturing centers in strategic locations across the globe.

About Kollmorgen

Kollmorgen, a Regal Rexnord brand, has more than 100 years of motion experience, proven in the industry's highest-performing, most reliable motors, drives, linear actuators, AGV (Automated Guided Vehicle) control solutions, and automation control platforms. We deliver breakthrough solutions that combine exceptional performance, reliability and ease of use, giving machine builders an irrefutable marketplace advantage.

KOLLMORGEN

A REGAL REXNORD BRAND

www.kollmorgen.com

Specifications are subject to change without notice. It is the responsibility of the product user to determine the suitability of this product for a specific application. All trademarks are the property of their respective owners

© 2023 Kollmorgen Corporation. All rights reserved