

Kollmorgen Stepper Motor

Selection Guide

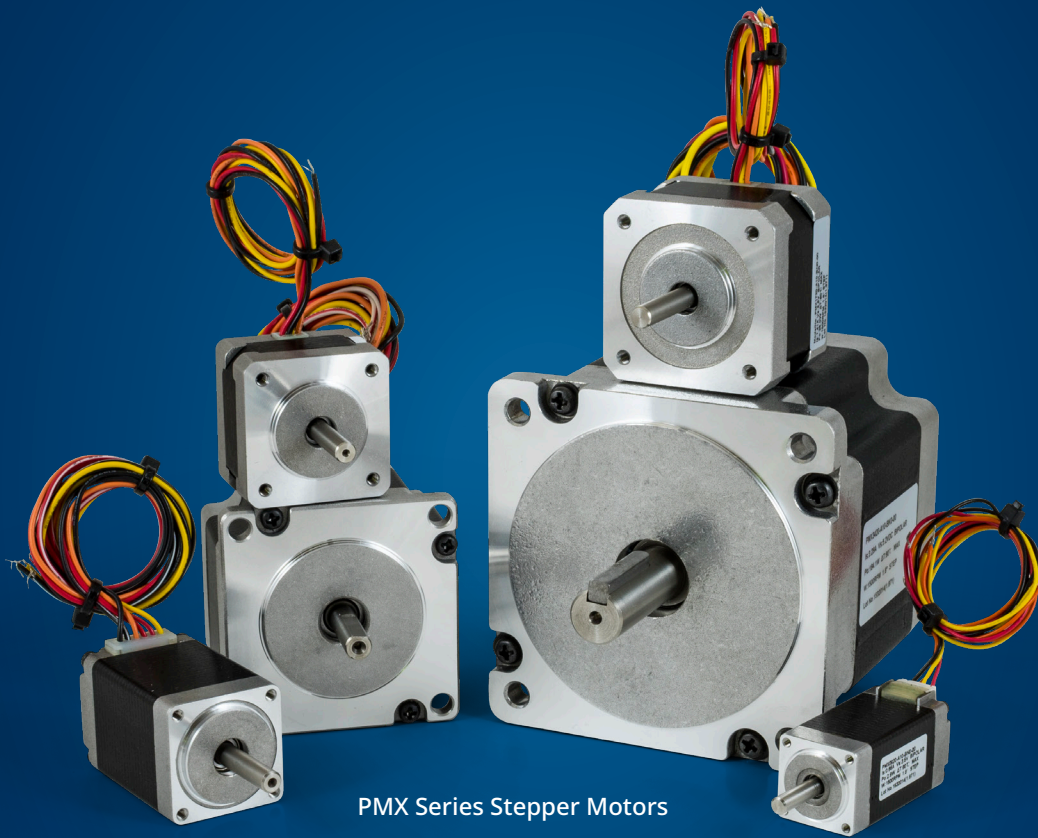

PMX Series Stepper Motors

KOLLMORGEN

A REGAL REXNORD BRAND

Kollmorgen: Your Partner, In Motion.

Every solution comes from a real understanding of the challenges facing machine designers and users.

Innovators consistently rate Kollmorgen as one of their best motion systems manufacturing partners. Whether you are looking for classic servo motors, direct-drive servo motors, stepper motors, drives & amplifiers, gearing, actuation, or multi-axis motion controllers, Kollmorgen is one of the few companies in the world that actually designs and manufactures all of these products.

Our customers are leaders in many industries such as Aerospace & Defense, Printing, Packaging & Converting, Food & Beverage Processing, Medical Imaging, In Vitro Diagnostics & Laboratory Automation, Pharmaceutical Manufacturing, Material Forming and Cutting, Oil & Gas, and Robotics. Kollmorgen is also a leader in Warehouse Automation, including complete AGV systems, software, awareness and autonomy.

Our Automation Solutions can be found on Mars and in space, ships and submarines, O&G drilling and metrology, surgical robots and laser eye surgery, even inside artificial hearts. These are just a few applications that demand high-performance and high-quality while satisfying their specific needs.

Because motion matters, it's our focus: Motion can distinctly differentiate a specific machine and deliver a marketplace advantage by increasing its performance and dramatically improving Overall Equipment Effectiveness (OEE).

High-performance motion can make your customer's machine more reliable and energy-efficient, enhance accuracy and improve operator safety. Motion also represents endless possibilities for innovation.

We've always understood this potential, and thus have kept motion at our core and in our Vision, Mission & Values, relentlessly developing products that offer precise control of torque, velocity and position accuracy in machines that rely on complex motion.

Table of Contents

▶ Stepper Motors	4	▶ POWERMAX II® M/P Series Stepper Motors	74
Hybrid Stepper Motor Technology	6	M/P Series General Specifications	75
Basic Stepper Motor Operation and Holding Torque	7	M2/P2 Series Motor Connection Information	76
Kollmorgen Stepper Motor Overview	8	M/P Series “X” Integrated Connector Option	77
▶ PMX™ Series Stepper Motor	10	M2/P2 Series Motor Nomenclature	78
PMX Modifications and Special Features	12	M2/P2 Series Motor Outline Drawings	79
PMX Series Technical Overview	13	M2/P2 Series Motor Performance Data & Curves	80
PMX Series Nomenclature	16	▶ POWERPAC® K/N Series Stepper Motors	86
PMX08 Series Options, Specifications & Dimensions	18	K/N Series General Specifications	88
PMX08 Series Performance Data and Curves	19	K/N Series Motor Nomenclature	89
PMX11 Series Options, Specifications & Dimensions	20	K/N Series Motor Connection Information	90
PMX11 Series Performance Data and Curves	21	K3/N3 Series Motor Outline Drawings	92
PMX14 Series Options, Specifications & Dimensions	24	K3/N3 Series Motor Performance Data & Curves	96
PMX14 Series Performance Data and Curves	25	K4/N4 Series Motor Outline Drawings	104
PMX17 Series Options, Specifications & Dimensions	28	K4/N4 Series Motor Performance Data & Curves	106
PMX17 Series Performance Data and Curves	29	K/N Series Motor Encoder Options	112
PMX23 Series Options, Specifications & Dimensions	36	▶ E/H Series Stepper Motors	114
PMX23 Series Performance Data and Curves	37	E/H Series General Specifications	115
PMX34 Series Options, Specifications & Dimensions	46	E/H Series Motor Connection Information	116
PMX34 Series Performance Data and Curves	47	E/H Series Motor Nomenclature	118
▶ CT Series Stepper Motors	52	E3/H3 Series Motor Outline Drawings	119
CT Series Motor Connection Information	54	E4/H4 Series Motor Outline Drawings	123
CT Series Stepper Motor Nomenclature	55	E3/H3 Series Motor Performance Data	124
CTP1 General Specifications & Dimensions	56	E4/H4 Series Motor Performance Data	128
CTP1 Performance Data and Curves	57	E/H Series Motor Encoder Options	130
CT(P/M)2 General Specifications & Dimensions	60	▶ MX Series Hazardous Duty Stepper Motors	132
CT(P/M)2 Performance Data and Curves	61	MX Series General Specifications	133
▶ T2 Series Stepper Motors	66	MX Series Motor Connection Information	134
T2 Series General Specifications	67	MX Series Motor Nomenclature	135
T2 Series Motor Connection Information	68	MX9 Specifications, Dimensions and Performance Data and Curves	136
T2 Series Stepper Motor Nomenclature	69	MX11 Specifications, Dimensions and Performance Data and Curves	138
T2 Outline Drawings, Performance Date and Curves	70	▶ Stepper Motor Application Worksheet	140
T2 Encoder Option	73		

Trademarks

AKD is a registered trademark of Kollmorgen Corporation
 AKM is a registered trademark of Kollmorgen Corporation
 Cartridge DDR is a registered trademark of Kollmorgen Corporation
 EnDat is a registered trademark of Dr. Johannes Heidenhain GmbH
 EtherCAT is a registered trademark and patented technology, licensed by Beckhoff Automation GmbH
 Ethernet/IP is a registered trademark of ODVA, Inc.
 Ethernet/IP Communication Stack copyright (c) 2009, Rockwell Automation
 sercos® is a registered trademark of sercos® international e.V.
 HIPERFACE and HIPERFACE DSL are registered trademarks of Max Stegmann GmbH
 PROFIBUS and PROFIBUS are registered trademarks of PROFIBUS and PROFIBUS International (PI)
 SIMATIC is a registered trademark of SIEMENS AG
 SpeedTec, ytec, itec and htec are registered trademarks of TE Connectivity Ltd.
 Windows is a registered trademark of Microsoft Corporation

► Stepper Motors

Kollmorgen's stepper motors are designed with versatility, ease-of-use, and cost-effectiveness in mind. They provide high torque in a small package and come in a wide range of standard sizes, constructions, windings and options.

Our high-performance, brushless, maintenance-free stepper motors provide very precise, extremely cost-effective motion control. These 2 phase stepper motors inherently move in small, very precise, 1.8° increments (200 steps/revolution). This stepping action is simple to control and does not require complicated, expensive feedback devices.

They are available with custom leads, shafts and connectors are routinely provided to effectively solve your application needs. Several models feature the addition of our innovative SIGMAX® technology for higher torque and acceleration rates.



K/N Series Stepper Motors



The Benefits of Stepper Motors

Our stepper motors provide high torque in a small package. They offer a wide range of standard sizes, constructions, windings and options. Custom leads, shafts and connectors are routinely provided to effectively solve your application needs.

- » 7 series in 5 frame sizes: NEMA 17, 23, 34, 42, 66
- » Models available with SIGMAX technology and high torque construction for maximum torque in the smallest package size
- » Holding torques from 33 - 6130 oz-in (0.23 - 43.3 Nm) to accommodate a wide range of applications
- » Speeds to 3,000 rpm to meet all low and medium speed applications
- » Choice of standard connection methods and IP ratings to meet environmental conditions of the application including:
 - integral connector
 - leads
 - terminal box
- » All models are CE compliant
- » Special modifications readily available: shafts, leads, connectors, etc.

Stepper Motors

Hybrid Stepper Motor Technology

Kollmorgen motors utilize high torque magnetic designs that feature a large rotor diameter, small air gap, high energy rotor magnets and windings. This provides maximum torque in the smallest package.

- Lower Energy Usage
- Faster Machines
- Lower System Cost
- More Compact Machines

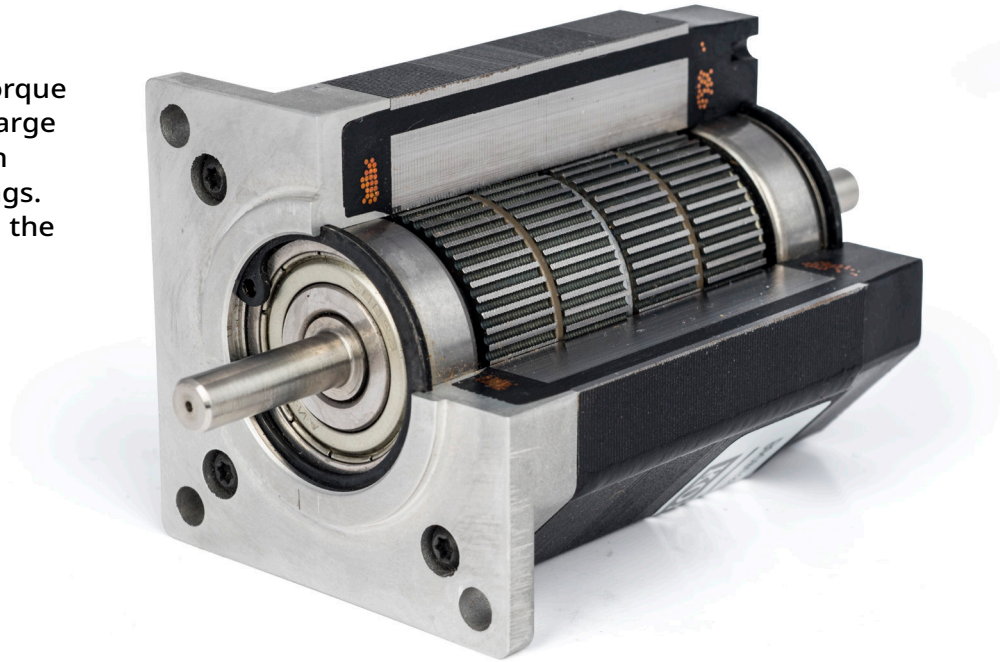

Kollmorgen Hybrid Stepper Motor

High Voltage Insulation

Inset molded insulation system encases the stator, eliminating joints and gaps that can fail. Reliability and voltage ratings are increased. Kollmorgen motors can be used with all standard drives, as well as high voltage high performance drives.

- » Faster design cycles knowing Kollmorgen motors work with all drives.
- » Higher reliability

Large Bearing System

To accommodate high thrust loads and high side loading, many motors feature large bearings.

- » Lower machine costs. Loads can be directly mounted on motor shaft eliminating couplings and load support bearings.
- » Excellent for leadscrew applications
- » Longer life

Basic Stepper Motor Operation

Kollmorgen Hybrid stepper motors have two windings (two phases) that are energized with DC current. When the current in one winding is reversed, the motor shaft moves one step, or 1.8°. By reversing the current in each winding the position and speed of the motor is easily and precisely controlled, making these motors extremely useful for many different motion control applications.

For even finer resolution and smoother operation, micro-stepping drives divide each step into many increments by controlling the magnitude of the current in each winding.

The performance of hybrid stepper motors is highly dependent on the current and voltage supplied by a drive. Kollmorgen stepper motors are available with a variety of windings so they can be used with drives that have a broad range of voltage and current ratings. Performance curves are included in this catalog for many common motor drive combinations.

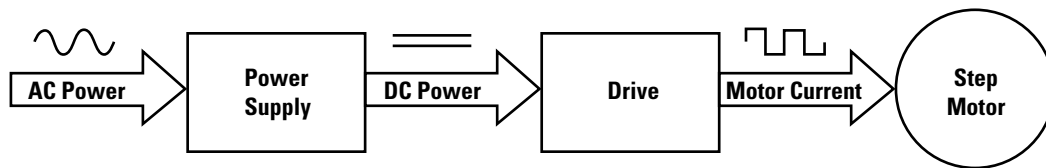

Holding Torque

Because motor performance at speed varies greatly with the drive, holding torque is used to rate hybrid stepper motors. Holding torque specifies the maximum torque that can be applied to a motor shaft and not cause the shaft to rotate. It is measured with the motor at standstill and energized with rated DC current. Since the motor is energized with pure DC current, holding torque is not dependent on specific drive characteristics.

SIGMAX® Technology

- Smaller drives = Lower system cost
- More torque = Smaller, faster machines
- Higher efficiency = Lower operating costs

Through the use of enhancing technology, Kollmorgen stepper motors provide the maximum performance available. This patented technology boosts torque an additional 25% across the entire speed range and allows machines to be designed that are smaller and move faster.

Initial system costs are often less with enhanced motors because the additional torque is produced without the need for larger drives or power supplies. The additional output power is produced through higher efficiency. The higher efficiency reduces energy usage by 25% and lowers operating costs.

SIGMAX® motors use additional magnets inserted between each stator tooth. These magnets block the magnet fields from flowing around the stator teeth. This forces more of the magnetic field to flow through each tooth where it produces torque.

Standard Stepper Motor

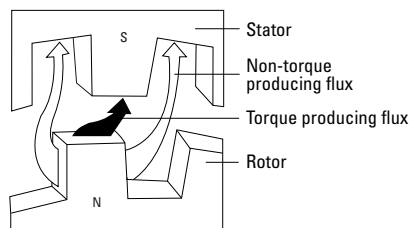

Typical paths of flux transfer in an energized conventional hybrid stepper motor. Some flux leakage occurs in normal operation.

Enhanced Stepper Motor

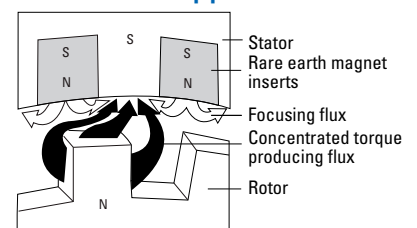

Patented enhancing technology redirects magnetic flux to inhibit leakage and optimize torque production.

Kollmorgen Stepper Motor Overview

Kollmorgen offers a comprehensive range of stepper motor products including continuous torque, high torque and hybrid options to meet a wide range of application requirements. For other Kollmorgen stepper products or information not included in this catalog go to www.kollmorgen.com.

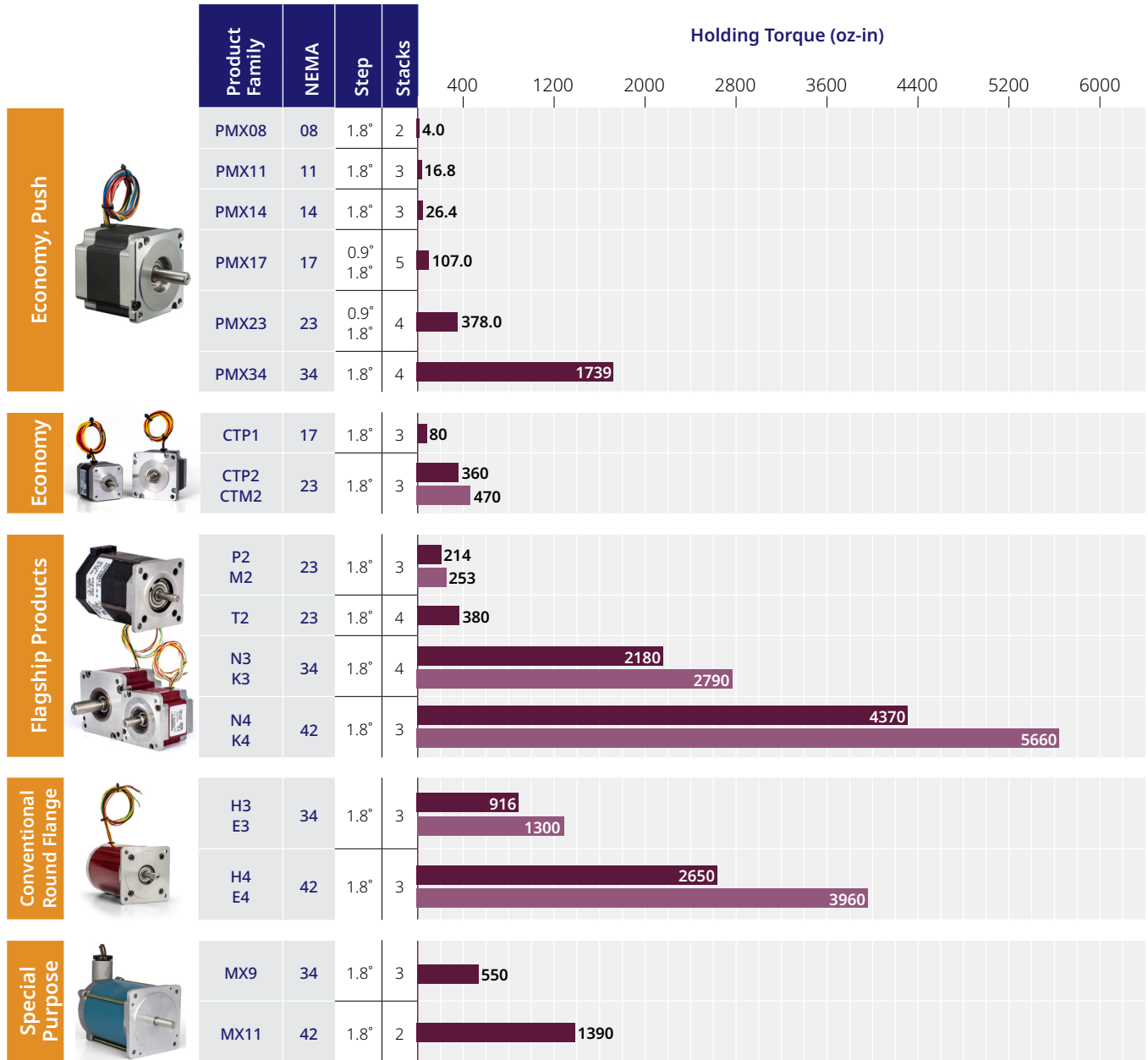

Standard Stepper Motor Construction
 Step motor utilizing SIGMAX® Technology

Product Family	NEMA	Features				Standard Options ◦ = available option											Family Features				
		UL Recognized	CE Mark	RoHS	SIGMAX® Technology	Integral Connectoin	Leadwire	4-Lead Bipolar	6-Lead Unipolar	8-Lead	Terminal Box	MS Connector	IP Sealing	Encoders	Front Shaft			Rear Shaft	Low Inertia		
PMX08	08		•	•			•	•						30		◦	•		•		<ul style="list-style-type: none"> » NEMA Sizes 8, 11, 14, 17, 23, 34 » CE, RoHS, and REACH Compliant » Unipolar or Bipolar windings » Options: shaft flats, rear shaft with encoder mounting holes, IP Sealing » Special Options readily available: spur and planetary gearboxes, encoders, special shafts
PMX11	11		•	•			•	•						30		◦	•		•		
PMX14	14		•	•			•	•						30		◦	•		•		
PMX17	17		•	•		•	•	•	◦					30		◦	•		•		
PMX23	23		•	•		•	•	•	◦					30		◦	•		•		
PMX34	34		•	•		•	•							30		◦	•	◦	•		
CTP1	17		•	•			•	•	•					40		•			•		<ul style="list-style-type: none"> » High torque standard CTP models » Enhanced CTM SIGMAX models produce up to 25% more torque in same package » Large bearings provide high thrust and radial loads
CTP2 CTM2	23		•	•	•		•	•	•					40		•	◦		•		
P2 M2	23	•	•	•	•	•	•			•				40 40	•	•	◦		•	•	<ul style="list-style-type: none"> » High torque standard hybrid stepper motor » Enhanced M and K SIGMAX models provide up to 25% more torque in same package » Low detent torque for smoother microstepping » Bipolar and unipolar winding » Large array of options
T2	23		•				•	•	•		•	•		40	•	•	◦		•		
K3 N3	34	•	•			•	•	•	•	•	•	•	•	65 ¹ 65 ¹	•			•	•		
K4 N4	42	•	•		•	•	•	•	•	•	•	•	•	65 ¹ 65 ¹	•			•	•		
H3 E3	34	•	•		•		•	•	•	•		•		65 ¹ 65 ¹	•	•	◦		•		<ul style="list-style-type: none"> » High efficiency, low loss hybrid designs in a conventional round frame » Enhanced E SIGMAX models provide up to 25% more torque in the same package » Torque produced over a wide speed range » Large array of options » E2, H2 offer high axial loading
H4 E4	42	•	•		•		•	•	•	•		•		65 ² 65 ²	•			•	•		
MX9	34	•												40		•			•		<ul style="list-style-type: none"> » Standard hybrid stepper motor » Meets Explosion proof UL Class 1, Division 1 Group D requirements » Up to 150% rated torque reserve capacity (MX9) and 200% for (MX11)
MX11	42	•												40			•		•		

Notes: 1. Requires shaft seal and connection option other than leaded (Meets IP40 otherwise)
2. Requires shaft seal option (Meets IP40 otherwise)

▶ PMX™ Series Stepper Motor

Kollmorgen's stepper motors are designed with versatility, ease-of-use, and cost-effectiveness in mind. They provide high torque in a small package and come in a wide range of standard sizes, constructions, windings and options.

Our high-performance, brushless, maintenance-free stepper motors provide very precise, extremely cost-effective motion control. These hybrid stepper motors inherently move in small, very precise, 0.9°, or 1.8° increments (400 or 200 steps/revolution). This stepping action is simple to control and does not require complicated, expensive feedback devices.

PMX Series motors are commonly built with special modification and value-added features. Custom leads, shafts, and connectors are routinely provided to effectively solve your application needs.

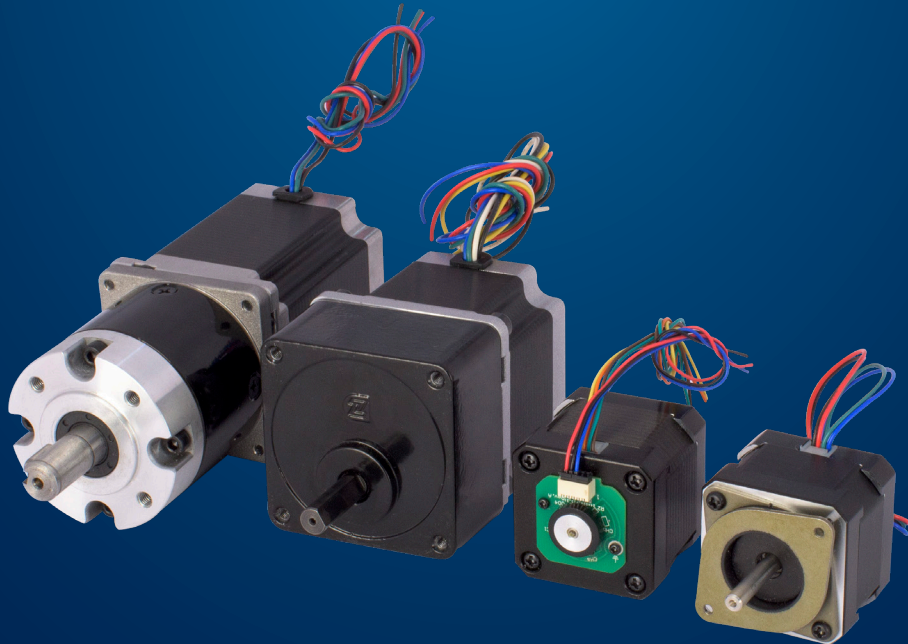

Kollmorgen's PMX™ stepper motor line delivers breadth and design flexibility at competitive lead times.

Kollmorgen is excited to continue its winning heritage in hybrid stepper motors with the PMX family. Leveraging the best practices from customer preferred products in the POWERMAX and POWERPAC families, the PMX lines will deliver breadth and design flexibility at a very competitive lead time. Look no further for that hybrid stepper motor family with local support that gives you the flexibility you need to succeed.

PMX Series motors include smaller Nema 08, 11, and 14 frame sizes in addition to the traditional Nema 17, 23, and 34 frame sizes. Each frame size is built with high quality construction in an affordable, market competitive solution. Numerous co-engineering options are also available including: customizing shafts, encoders, and mounted spur and planetary gearboxes.

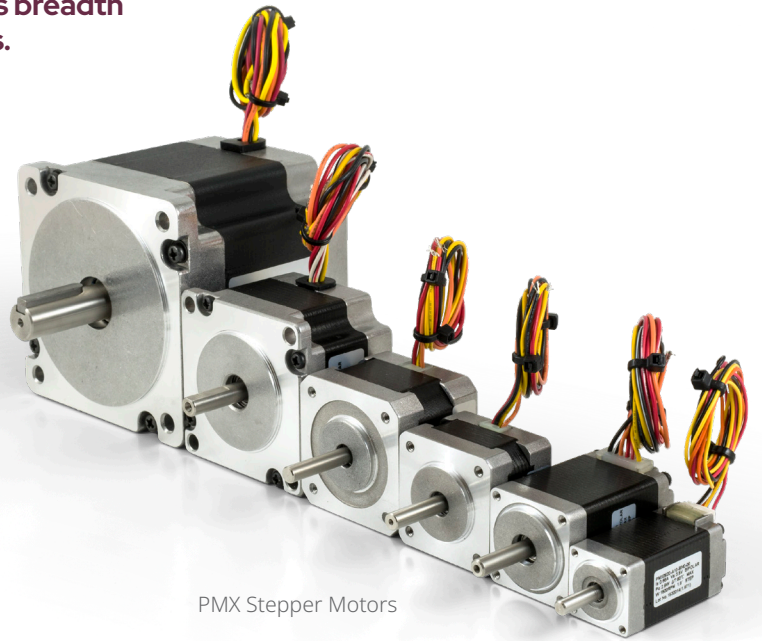

PMX Stepper Motors

- » **Increased Design Flexibility** – six frame sizes (08, 11, 14, 17, 23, 34) each with several stack length and winding options available
- » **Minimal Drive Adjustments** – options for 1.8 and 0.9 degree step angles
- » **Lower Unit Cost** – PMX motors are priced competitively in today's current stepper market and are the lowest of all Kollmorgen stepper products
- » **Quality Construction** translates to reliability in the field and a long service life
- » **Localized Support** gives you the delivery terms and immediate technical support you need, meaning quicker time to market and less downtime
- » **Flexible Manufacturing** enables Kollmorgen to immediately evaluate modifications and co-engineered solutions for rapid prototyping
- » **Easy to Apply Worldwide** – CE, RoHS, REACH

Many Applications

PMX motors allow Kollmorgen customers to fulfill their automation needs at an affordable cost, enabling higher throughput in a wide variety of equipment. In addition, leveraging Kollmorgen's technical expertise and flexible engineering, the PMX is ready for seamless special and co-engineering options, allowing for swifter and easier integration into both new and existing applications.



Chemical Analyzers

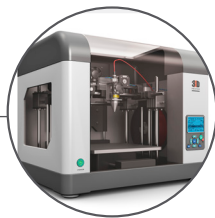

3-D Printers

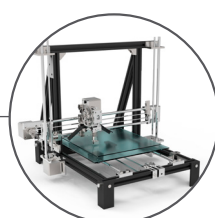

Tabletop Equipment

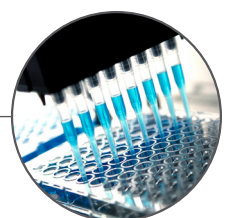

Metering Pumps

PMX™ Modifications and Special Features

Kollmorgen's flexible manufacturing is shifting the viewpoint on custom motor capabilities.

Kollmorgen offers extensive experience in stepper motor enhancements and value-added stepper motor assemblies. Localized support provides technical solutions, leading to swifter prototype evaluation and time-to-market. Kollmorgen's ability to co-engineer – customize shafts, lead wires, connectors, encoders, gearboxes, etc – provides real flexibility to optimize each motor, making it easier to drop into existing applications with minimal adjustments.

Shaft Modifications

A variety of motor output shaft modifications can be supplied, allowing swifter integration into drive mechanism.

- » Special shaft diameters and shaft lengths
- » Special shaft details including: flats, dual flats, slots, and thru holes
- » Spline shafts, helical gears, fixed acme lead screws

Electrical Modifications

Kollmorgen can swiftly evaluate special winding considerations and attempt to match current, resistance, or inductance requirements for swifter control integration.

Connectors and Cabling

Motors can be supplied with customer-specified connectors for swifter incorporation into existing cabling. Non-standard lead lengths and cable options can also be ordered.

Encoders

Kollmorgen can supply and mount customer-specified encoders. This includes different encoder types (i.e. incremental, absolute) and line counts.

Gearboxes

Kollmorgen can provide spur and planetary gearbox customized solutions. These can extend the torque range of the motors and ship pre-mounted from the factory for your convenience.

Complete Sub-Assemblies



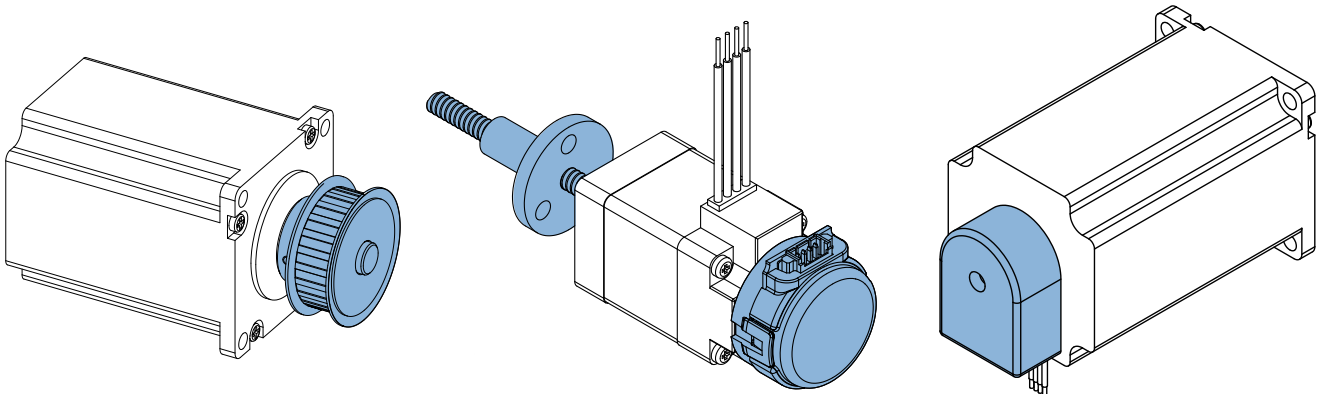

Partnering with Kollmorgen for full co-engineering design adds significant value in motion selection. Complete sub-assembly solutions mean less integration and engineering to perform. Sub-assemblies can ship directly from the factory allowing for reduced machine SKU count and swifter production readiness.



To review non-standard capabilities, contact Kollmorgen today at www.kollmorgen.com

PMX™ Series Technical Overview

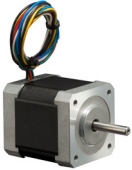
PMX Stepper Motor General Specifications

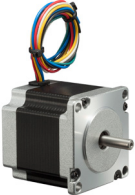
	Series	Stacks	Holding Torque (Motor Mounted)		Length		Features
			Bipolar		in	mm	
			oz-in	Nm			
Size 08 PMX Series 	2 Phase, 1.8° Step Motors. Frame size: 0.8 inch, 20 mm						
	PMX081	1	2.50	0.018	1.18	30.0	<ul style="list-style-type: none"> • Front shaft flat option • Rear shaft option
	PMX082	2	4.00	0.028	1.65	42.0	
Size 11 PMX Series 	2 Phase, 1.8° Step Motors. Frame size: 1.1 inch, 28 mm						
	PMX111	1	10.1	0.071	1.26	32.0	<ul style="list-style-type: none"> • Front shaft flat option • Rear shaft option • Integral connector option
	PMX112	2	16.1	0.114	1.77	45.0	
PMX113	3	16.8	0.119	2.01	51.0		
Size 14 PMX Series 	2 Phase, 1.8° Step Motors. Frame size: 1.4 inch, 35 mm						
	PMX141	1	14.7	0.104	1.02	26.0	<ul style="list-style-type: none"> • Front shaft flat option • Rear shaft option • Rear encoder mounting holes
	PMX142	2	20.1	0.142	1.10	28.0	
PMX143	3	26.4	0.186	1.42	36.0		
Size 17 PMX Series 	2 Phase, 0.9° or 1.8° Step Motors. Frame size: 1.7 inch, 42 mm						
	PMX171 (1.8)	1	28.4	0.201	1.02	26.0	<ul style="list-style-type: none"> • Front shaft flat option • Rear shaft option • Integral connector option • Bipolar or Unipolar winding available • Rear encoder mounting holes
	PMX172 (1.8)	2	40	0.281	1.32	33.5	
	PMX173 (1.8)	3	61	0.427	1.56	39.5	
	PMX174 (1.8)	4	78	0.551	1.87	47.5	
PMX171 (1.8)	5	107	0.756	2.36	60.0		
Size 23 PMX Series 	2 Phase, 0.9° or 1.8° Step Motors. Frame size: 2.2 inch, 57 mm						
	PMX231 (1.8)	1	102	0.722	1.61	41.0	<ul style="list-style-type: none"> • Front shaft flat option • Bipolar or Unipolar winding available • Rear shaft option • Integral connector option • Rear encoder mounting holes
	PMX232 (1.8)	2	208	1.47	2.20	56.0	
	PMX233 (1.8)	3	337	2.38	2.99	76.0	
PMX234 (1.8)	4	378	2.67	3.35	85.0		
Size 34 PMX Series 	2 Phase, 1.8° Step Motors. Frame size: 3.4 inch, 86 mm						
	PMX341	1	490	3.46	2.56	65.0	<ul style="list-style-type: none"> • Front shaft flat option • Rear shaft option
	PMX342	2	704	4.97	3.15	80.0	
	PMX343	3	1285	9.07	4.65	118.0	
PMX344	4	1739	12.28	6.14	156.0		

PMX™ Series Technical Overview

PMX™ Common Ratings and Characteristics

	PMX08	PMX11	PMX14	PMX17	PMX23	PMX34
Phases	2					
Full Steps Per Revolution	200	200	200	200	400	200
Step Size Angle	1.8°	1.8°	1.8°	1.8°	0.9°	1.8°
Step Angle Accuracy	+/- 5.0%					
Maximum Case Temperature	130° C					
Insulation Class	NEMA Class B, 130° C					
Insulation Resistance	100 Megaohms @ 500 Vdc					
Ambient Temperature	-20.0 to + 40.0 °C					
Dielectric Strength	500 Vac, 1 minute					

PMX Shaft Loading

Motor Frame Size	Max Radial Force at Distance "D" from Mounting Face lb [N]	Dimension "D" inches [mm]	Max Axial Force lb [N]
PMX08	3.4 [15]	0.787 [20.0]	1.4 [6]
PMX11	6.3 [28]		2.3 [10]
PMX14	6.3 [28]		2.3 [10]
PMX17	6.3 [28]		2.3 [10]
PMX23	16.9 [75]		3.4 [15]
PMX34	49.5 [220]		16.5 [60]

Notes:

PMX motors do not include captured front bearings. They may be operated up to the maximum radial and axial loads and achieve an L10 life > 10,000 hours at speeds up to 3000 RPM. For applications with high radial/axial loading, it is recommended that an alternative Kollmorgen stepper series, with heavy duty, long-life bearings, be evaluated.

PMX Agency Approval



CE, Compliance with Directive 2014/30/EU

PMX08 – PMX17
EN 61000-6-3:2007/
A1:2011
EN 61000-6-2:2005
EN 55014-2:1997/
A2:2008

PMX23 – PMX34
EN 61000-6-3:2007/
A1:2011
EN 61000-6-2:2005
EN 55014-2:1997/
A2:2008
EN 60034-1:2010



RoHS, Compliance with Directive 2011/65/EU

PMX08 – PMX34



PMX08 – PMX34

PMX™ Connection Information

6-Lead Configuration

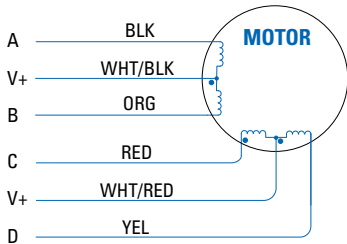

6-Lead Unipolar Connection

Driver Connection	Lead Color
A	Black (Blk)
B	Orange (Org)
C	Red
D	Yellow (Yel)
V+	Wht/Blk
V+	Wht/Red

Unipolar Full Step Phase Sequence

STEP	A	B	C	D
1	GND	0	GND	0
2	0	GND	GND	0
3	0	GND	0	GND
4	GND	0	0	GND
1	GND	0	GND	0

CCW ↓ ↑ CW

4-Lead Configuration

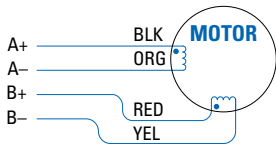

4-Lead Bipolar Connection

Driver Connection	Lead Color
A	Black
\bar{A}	Orange
B	Red
\bar{B}	Yellow

Bipolar Full Step Phase Sequence

STEP	A	\bar{A}	B	\bar{B}
1	+	-	-	+
2	-	+	-	+
3	-	+	+	-
4	+	-	+	-
1	+	-	-	+

CCW ↓ ↑ CW

Notes:

1. Indicated direction when viewed from the motor drive shaft end.
2. Because PMX series does not include any 8-lead configurations, Kollmorgen does not differentiate between Bipolar *Parallel* or *Series* within PMX series nomenclature. All 4-lead are simply stated as Bipolar. All Bipolar winding specifications in this guide represent simple 4-lead connection shown above.

Integral Connector Configurations

PMX17 Cable Assembly

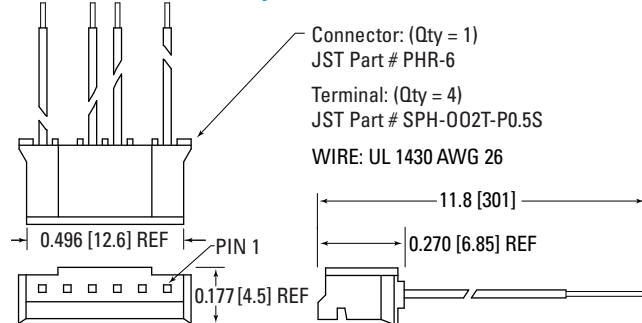

PMX23 Cable Assembly

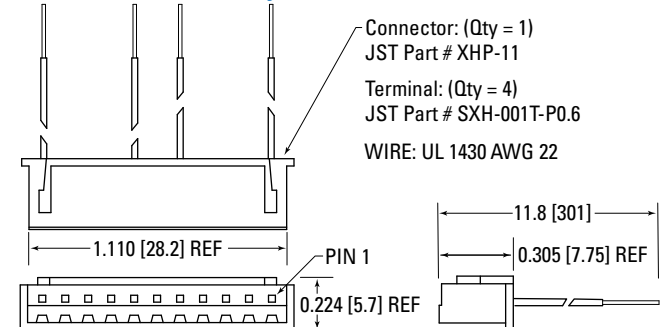

Notes:

1. A 4-lead Bipolar, 12 inch (300 mm) mating cable assembly is included for all motors ordered with Integral Connector option. The leadwires exiting this cable assembly should be connected same as 4-lead Bipolar shown above.
2. Upon special request, 6-lead Unipolar mating cables are available for Unipolar windings only. Please contact Kollmorgen Customer Support for more information.

PMX Series Nomenclature

PMX Series Stepper Motor Nomenclature

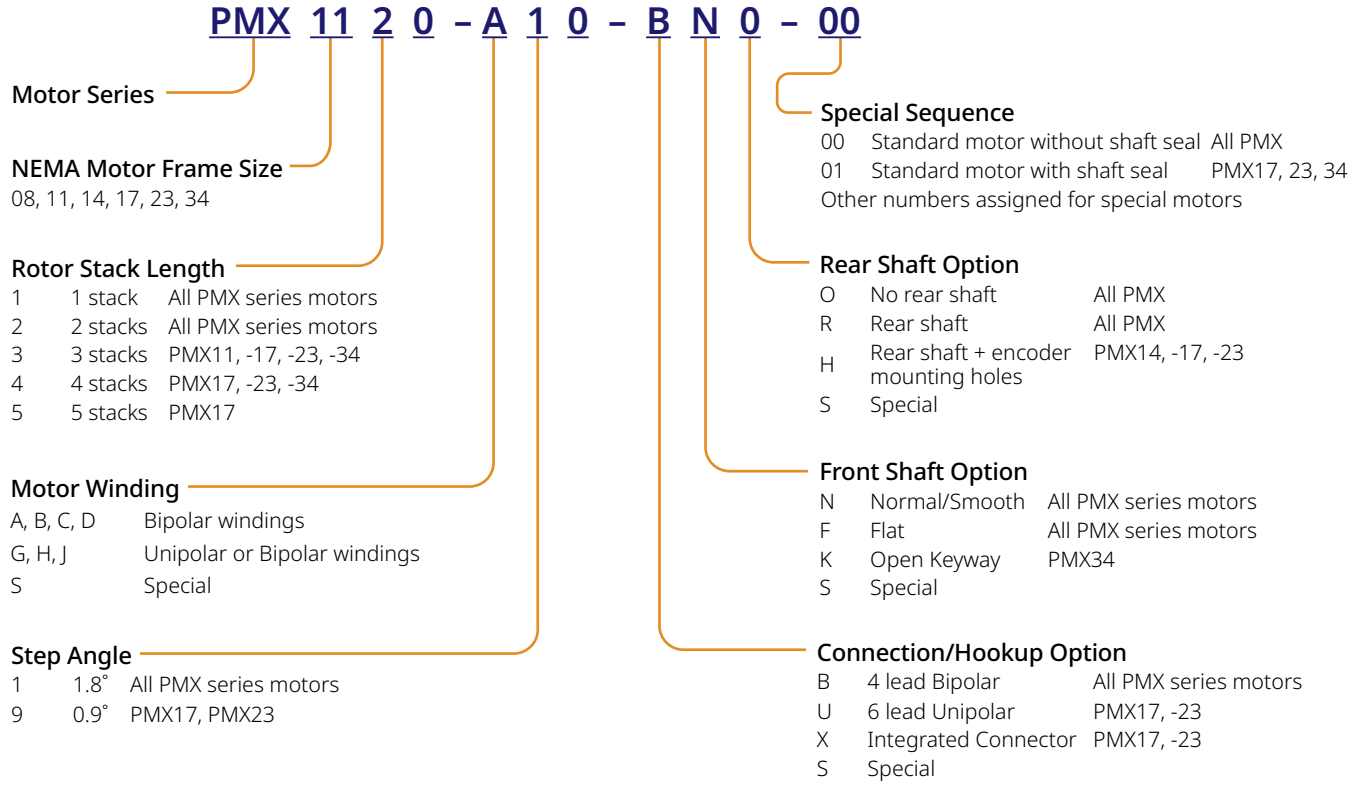

Notes

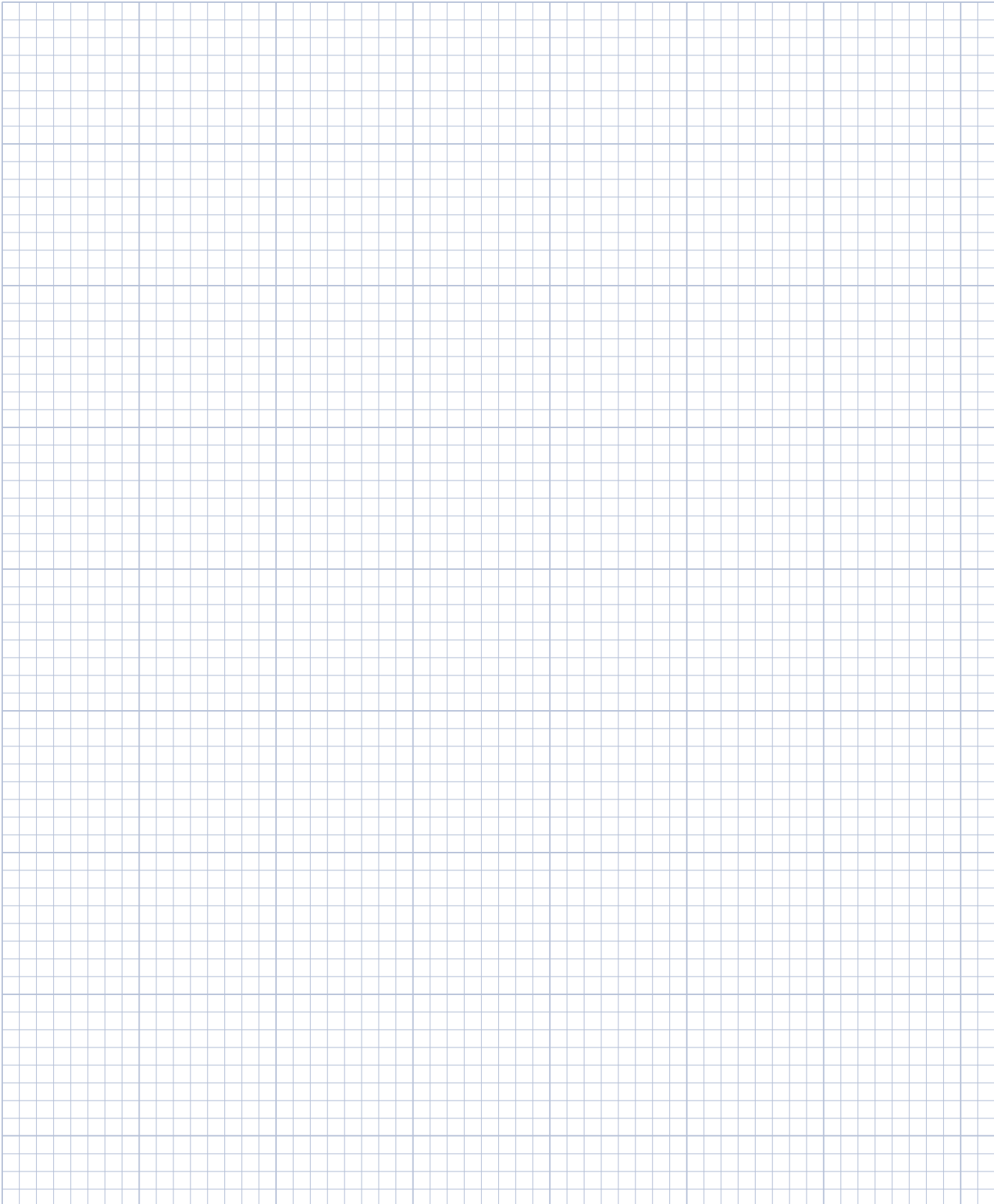

0.125 inch divisions

PMX08 Series Stepper Motors

PMX08 Standard Options and Specifications

- NEMA Size 08
- Smooth or Flat front shaft flat option
- Single or Rear shaft option
- Bipolar windings

Phases	2
Full Steps Per Revolution	200
Step Size Angle	1.8°
Step Angle Accuracy %	+/- 5.0
Maximum Case Temperature	130° C
Insulation Class	NEMA Class B, 130° C
Insulation Resistance	100 Megaohms @ 500 Vdc
Ambient Temperature	-20.0 to + 40.0° C
Dielectric Strength	500 Vac, 1 minute
Certifications:	CE, RoHS, REACH compliant



PMX08 Dimensions

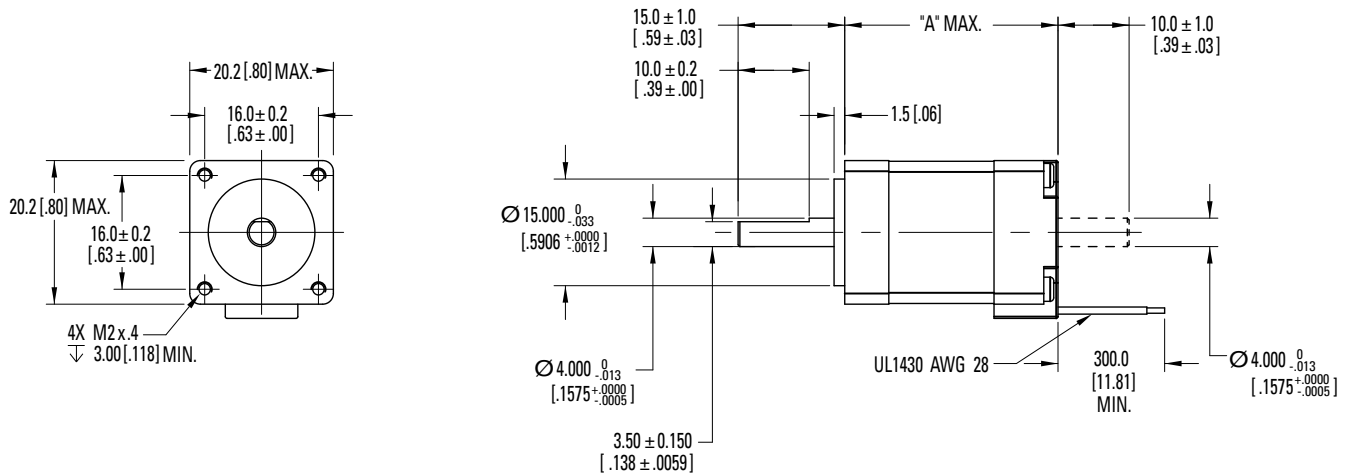

Model	"A" MAX
PMX081	30 [1.18]
PMX082	42 [1.65]

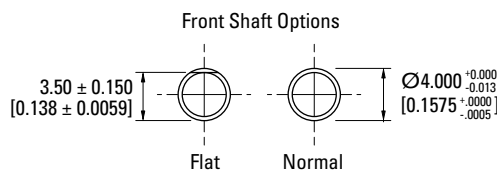

Dimensions in mm [inches]

PMX08 (1.8° Step) Performance Data

PMX08			Configuration		Holding Torque (2 phases on) oz-in [Nm] +/-12%	Rated Current/Phase Amps DC	Phase Resistance Ohms +/-10%	Phase Inductance mH Typical	Thermal Resistance Mounted °C/Watt	Rotor Inertia oz-in-s ² [kg-m ²]	Weight lb [kg]	Shaft Loading	
Stack	Winding	Step	Bipolar	Unipolar								Radial Force lb [N]	Axial Force lb [N]
1	A	1	•		2.5 [0.018]	0.53	6.70	2.00	15.85	2.84E-05 [2.01E-07]	0.1 [0.06]	4.50 [20.0]	0.45 [2.0]
2	A	1	•		4.0 [0.028]	0.66	5.28	1.64	12.99	5.11E-05 [3.61E-07]	0.2 [0.08]	4.50 [20.0]	0.45 [2.0]

Notes:

1. All ratings typical and at 40° C unless otherwise noted.
2. Rated current is $\Delta T = 80^\circ C$, ON-PLATE; motor mounted to square aluminum plate heatsink, 2.5X motor diameter, 5mm thick.
3. Small signal inductance as measured with impedance bridge @ 1 KHz, 1 amp.

PMX08 Series (Bipolar - 1.8° Step) Performance Curves

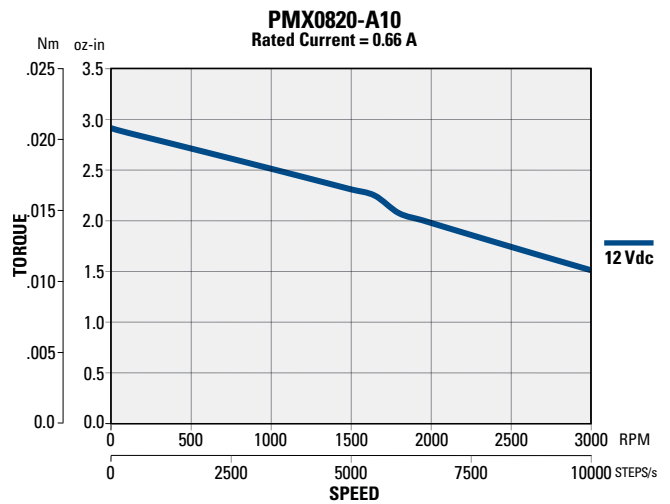
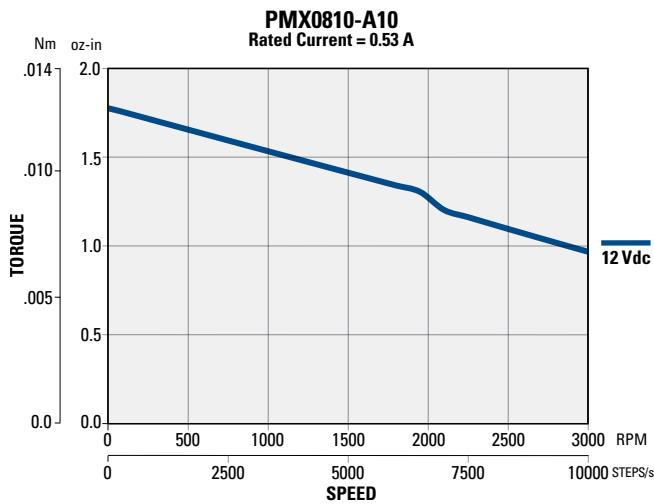

PMX11 Series Stepper Motors

PMX11 Standard Options and Specifications

- NEMA Size 11
- Front shaft flat option
- Rear shaft option
- Integral connector option
- Bipolar windings

Phases	2
Full Steps Per Revolution	200
Step Size Angle	1.8°
Step Angle Accuracy %	+/- 5.0
Maximum Case Temperature	130° C
Insulation Class	NEMA Class B, 130 °C
Insulation Resistance	100 Megaohms @ 500 Vdc
Ambient Temperature	-20.0 to + 40.0 °C
Dielectric Strength	500 Vac, 1 minute
Certifications:	CE, RoHS, REACH compliant

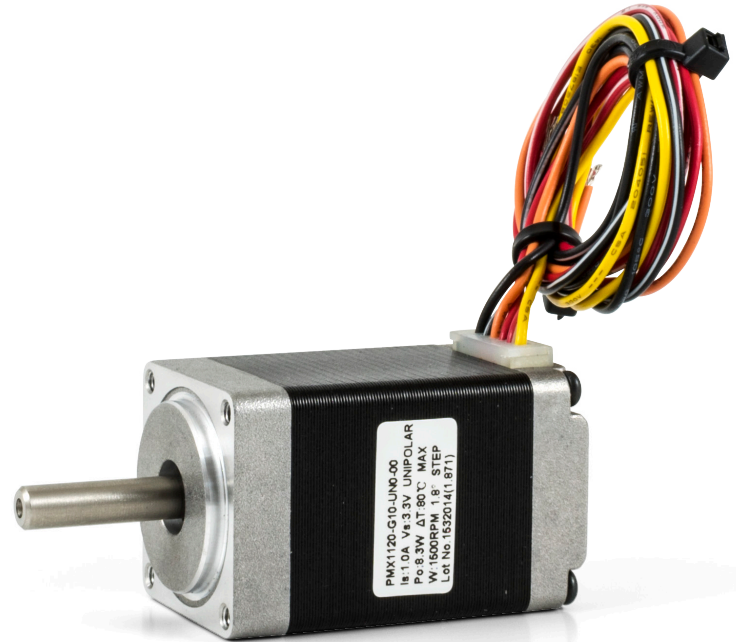

PMX11 Dimensions

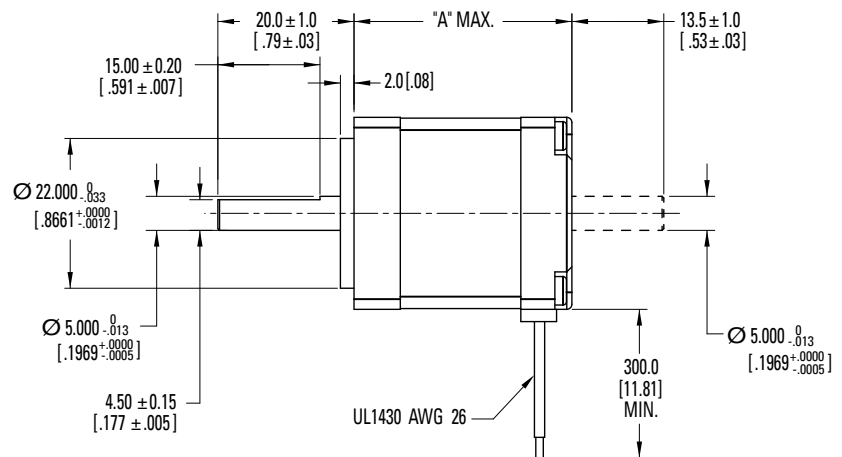
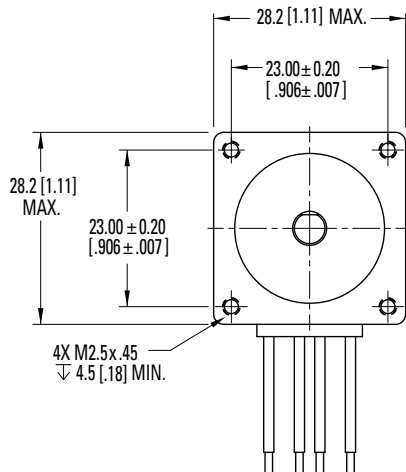

Model	"A" MAX
PMX111	32 [1.26]
PMX112	45 [1.77]
PMX113	51 [2.01]

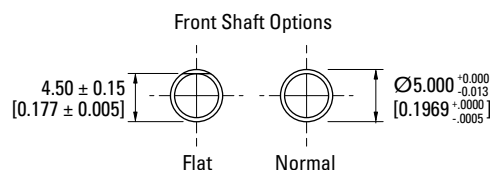

Dimensions in mm [inches]

PMX11 (1.8° Step) Performance Data

PMX11			Configuration		Holding Torque (2 phases on) oz-in [Nm] +/-12%	Rated Current/Phase Amps DC	Phase Resistance Ohms +/-10%	Phase Inductance mH Typical	Thermal Resistance Mounted °C/Watt	Rotor Inertia oz-in-s ² [kg-m ²]	Weight lb [kg]	Shaft Loading	
Stack	Winding	Step	Bipolar	Unipolar								Radial Force lb [N]	Axial Force lb [N]
1	A	1	•		9.9 [0.070]	1.38	1.50	0.89	11.17	1.28E-04 [9.00E-07]	0.2 [0.11]	6.30 [28.0]	2.25 [10.0]
1	B	1	•		10.1 [0.071]	0.70	5.41	3.57					
2	A	1	•		16.1 [0.114]	1.61	1.38	0.93	8.94	1.70E-04 [1.20E-06]	0.3 [0.14]	6.30 [28.0]	2.25 [10.0]
2	B	1	•		16.1 [0.114]	0.71	6.56	4.78					
3	A	1	•		16.8 [0.119]	1.53	1.61	1.20	8.35	2.56E-04 [1.81E-06]	0.4 [0.20]	6.30 [28.0]	2.25 [10.0]
3	B	1	•		16.7 [0.118]	0.63	9.07	7.01					

Notes:

1. All ratings typical and at 40° C unless otherwise noted.
2. Rated current is T = 80° C, ON-PLATE; motor mounted to square aluminum plate heatsink, 2.5X motor diameter, 5mm thick.
3. Small signal inductance as measured with impedance bridge @ 1 KHz, 1 amp.

PMX11 Series Stepper Motors

PMX11 Series (Bipolar - 1.8° Step) Performance Curves

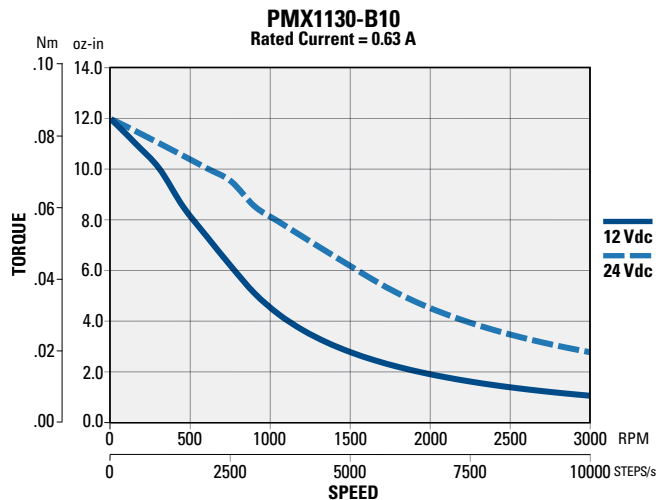
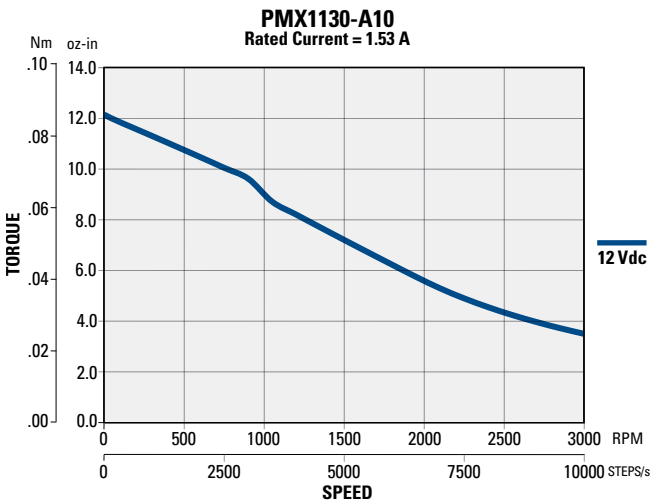
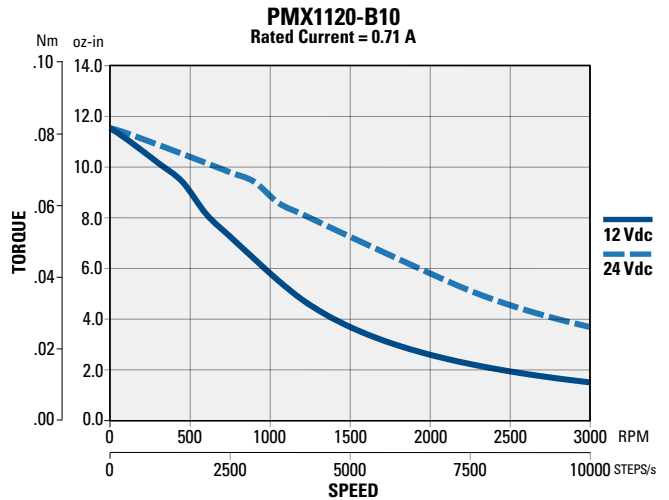
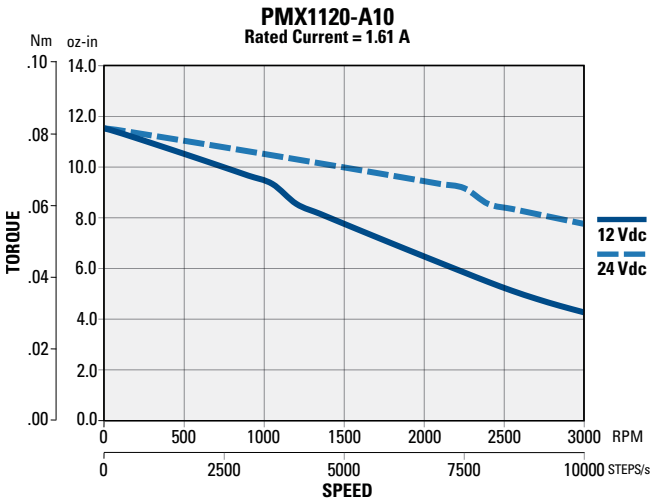
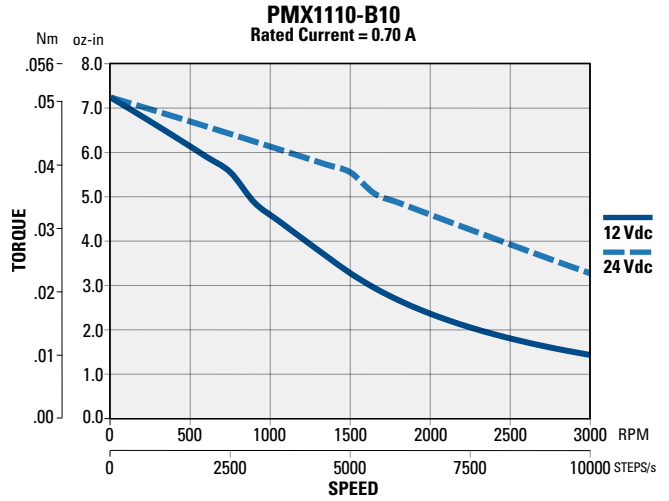
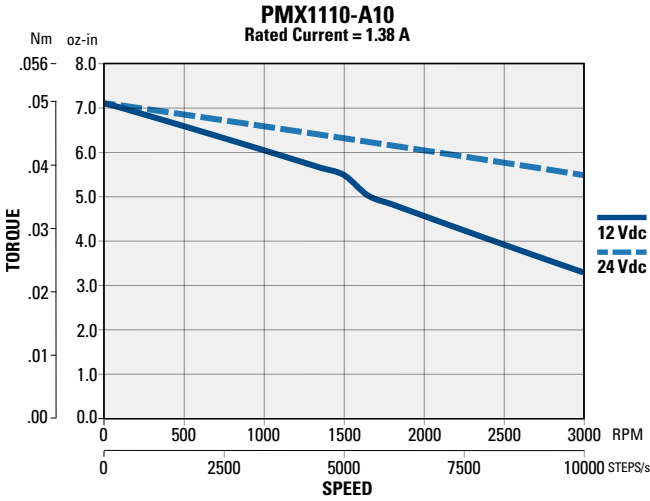

Notes

PMX | **11** | **2** | **0** | **-** | **G** | **1** | **0** | **-** | **B** | **N** | **0** | **-** | **00**
Motor Series | Frame Size | Stack Length | Winding | Step Angle | Connection | Front Shaft Opt. | Rear Shaft Opt.

0.125 inch divisions

PMX14 Series Stepper Motors

PMX14 Standard Options and Specifications

- NEMA Size 14
- Front shaft flat option
- Single, rear shaft, or rear shaft + encoder holes option
- Bipolar windings

Phases	2
Full Steps Per Revolution	200
Step Size Angle	1.8°
Step Angle Accuracy %	+/- 5.0
Maximum Case Temperature	130° C
Insulation Class	NEMA Class B, 130 °C
Insulation Resistance	100 Megaohms @ 500 Vdc
Ambient Temperature	-20.0 to + 40.0 °C
Dielectric Strength	500 Vac, 1 minute
Certifications:	CE, RoHS, REACH compliant

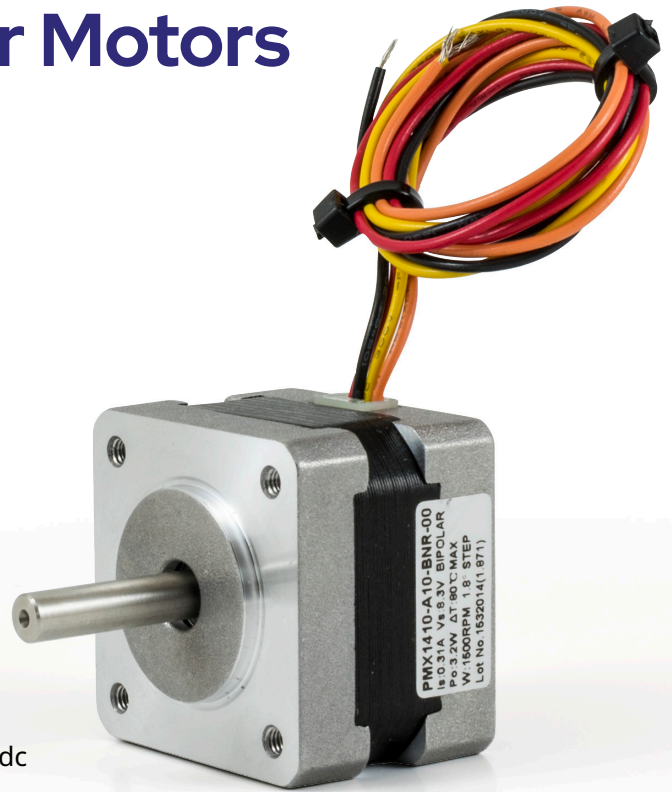

PMX14 Dimensions

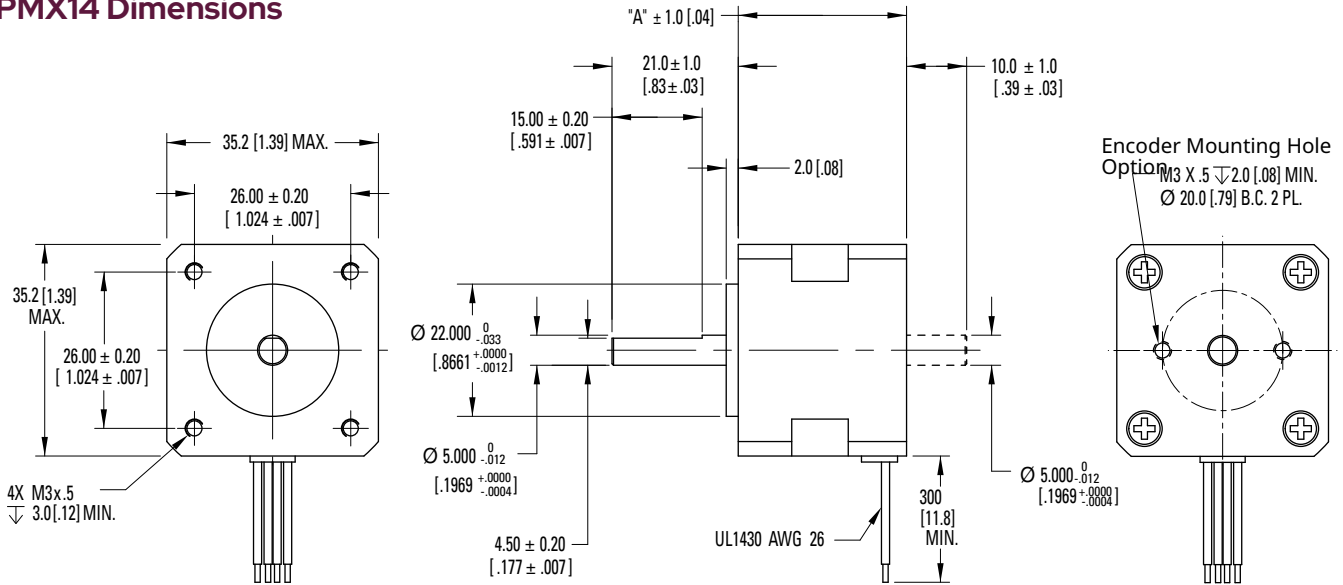

Model	"A" MAX
PMX141	26 [1.02]
PMX142	28 [1.10]
PMX143	36 [1.42]

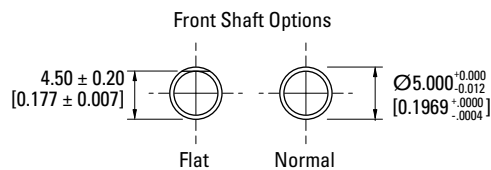

Dimensions in mm [inches]

PMX14 (1.8° Step) Performance Data

PMX14			Configuration		Holding Torque (2 phases on) oz-in [Nm] +/-12%	Rated Current/Phase Amps DC	Phase Resistance Ohms +/-10%	Phase Inductance mH Typical	Thermal Resistance Mounted °C/Watt	Rotor Inertia oz-in-s ² [kg-m ²]	Weight lb [kg]	Shaft Loading	
Stack	Winding	Step	Bipolar	Unipolar								Radial Force lb [N]	Axial Force lb [N]
1	A	1	•		13.5 [0.095]	0.31	28.61	30.62	10.81	1.420E-04 [1.00E-06]	0.3 [0.13]	6.30 [28.0]	2.25 [10.0]
1	B	1	•		14.7 [0.104]	0.70	5.69	7.75					
2	A	1	•		15.8 [0.112]	0.36	22.23	14.63	10.11	1.560E-04 [1.10E-06]	0.3 [0.14]	6.30 [28.0]	2.25 [10.0]
2	B	1	•		19.8 [0.140]	0.74	5.43	6.56					
2	C	1	•		20.1 [0.142]	1.41	1.54	1.86					
3	A	1	•		26.3 [0.186]	1.21	2.57	4.39	8.00	1.990E-04 [1.41E-06]	0.4 [0.18]	6.30 [28.0]	2.25 [10.0]
3	B	1	•		26.1 [0.184]	0.82	5.49	9.30					
3	C	1	•		26.4 [0.186]	1.60	1.51	2.54					

Notes:

1. All ratings typical and at 40° C unless otherwise noted.
2. Rated current is T = 80° C, ON-PLATE; motor mounted to square aluminum plate heatsink, 2.5X motor diameter, 5mm thick.
3. Small signal inductance as measured with impedance bridge @ 1 KHz, 1 amp.

PMX14 Series Stepper Motors

PMX14 Series (Bipolar - 1.8° Step) Performance Curves

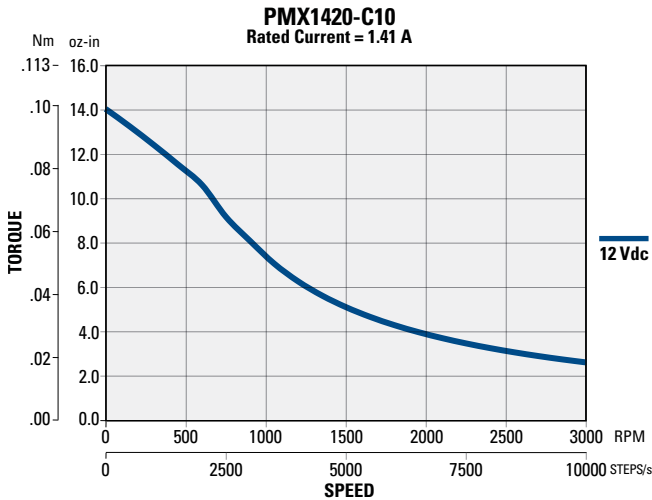
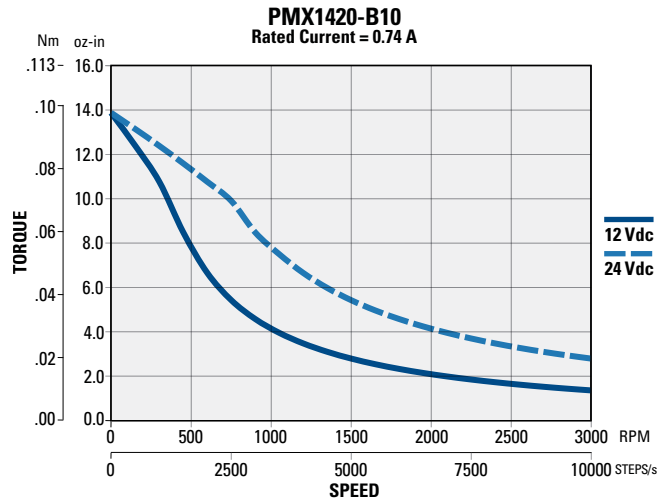
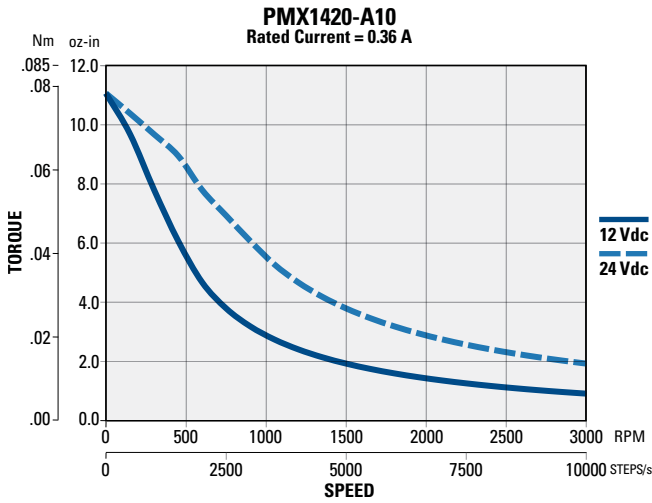
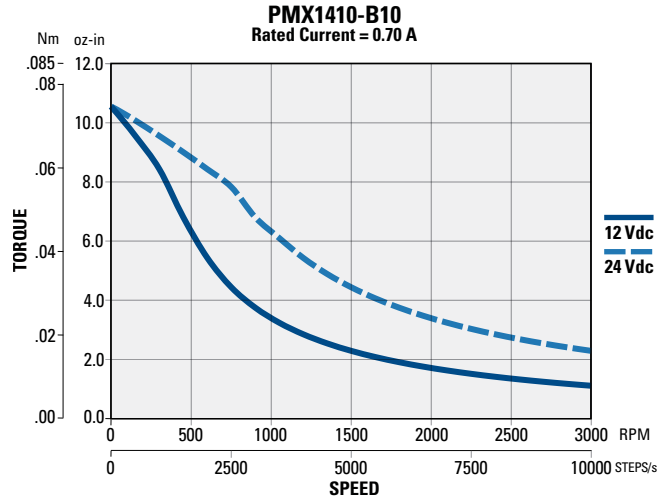
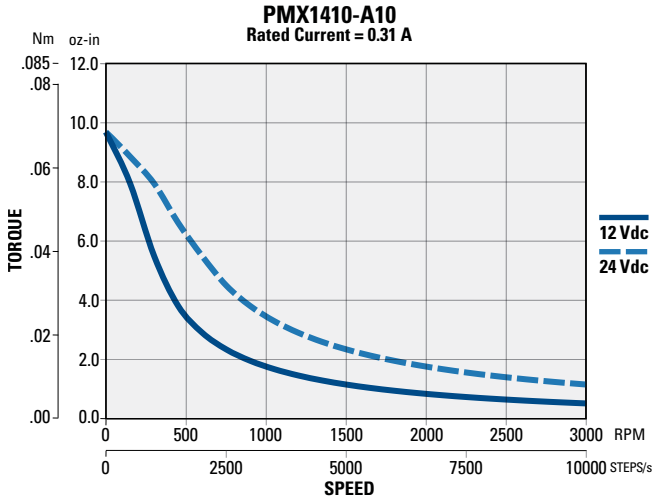

PMX | **14** | **2** | **0** - **A** | **1** | **0** - **B** | **N** | **0** - **00**
 Motor Series | Frame Size | Stack Length | Winding | Step Angle | Connection | Front Shaft Opt. | Rear Shaft Opt.

PMX14 Series (Bipolar - 1.8° Step) Performance Curves

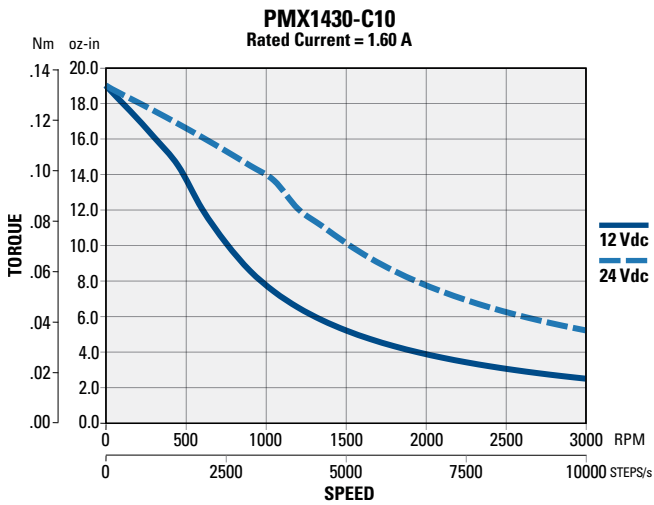
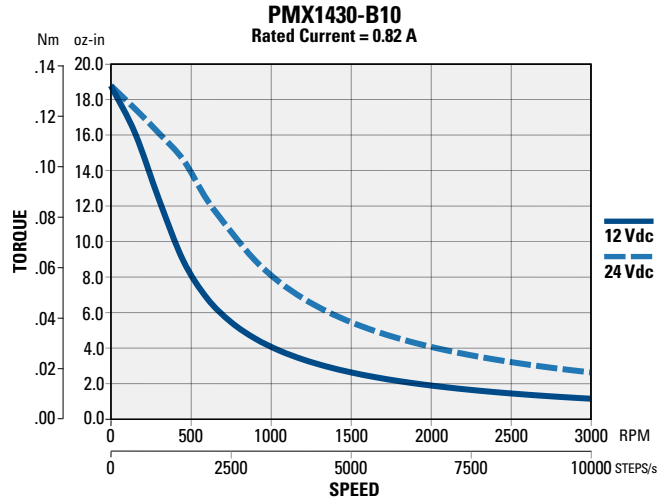
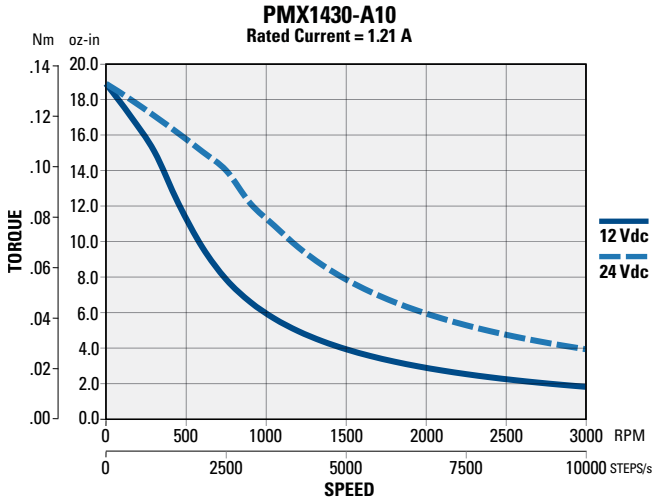

PMX17 Series Stepper Motors

PMX17 Standard Options and Specifications

- NEMA Size 17
- Front shaft flat option
- Rear shaft option
- Integral connector option
- Rear encoder mounting holes
- Bipolar and Unipolar windings

Phases	2
Full Steps Per Revolution	200
Step Size Angle	1.8°, 0.9°
Step Angle Accuracy %	+/- 5.0
Maximum Case Temperature	130° C
Insulation Class	NEMA Class B, 130 °C
Insulation Resistance	100 Megaohms @ 500 Vdc
Ambient Temperature	-20.0 to + 40.0 °C
Dielectric Strength	500 Vac, 1 minute
Certifications:	CE, RoHS, REACH compliant

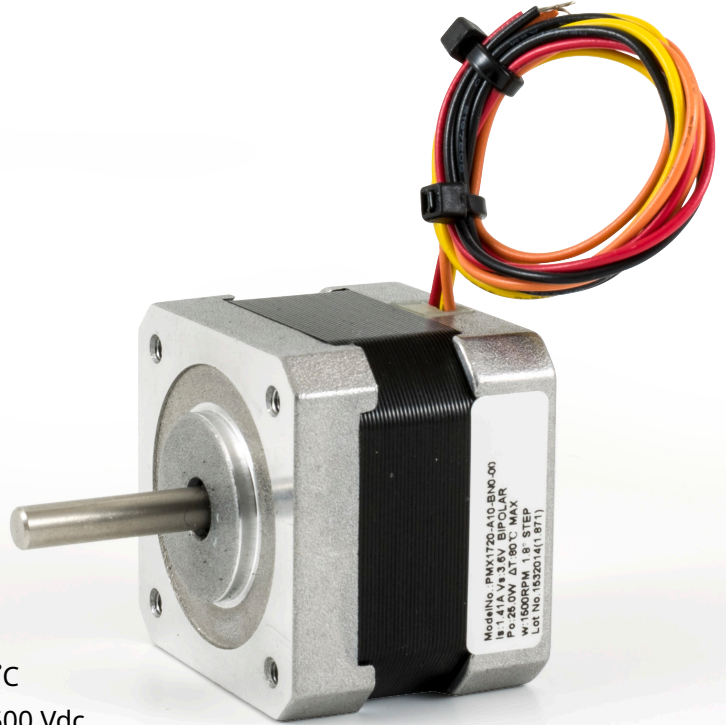

PMX17 Dimensions

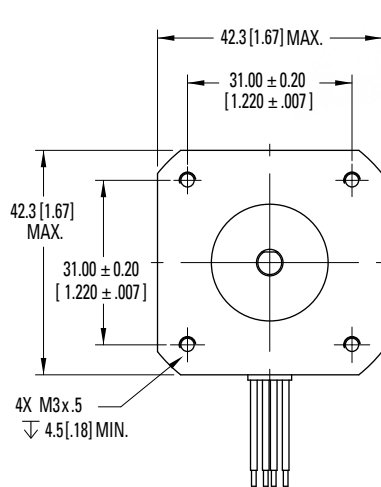

Dimensions in mm [inches]

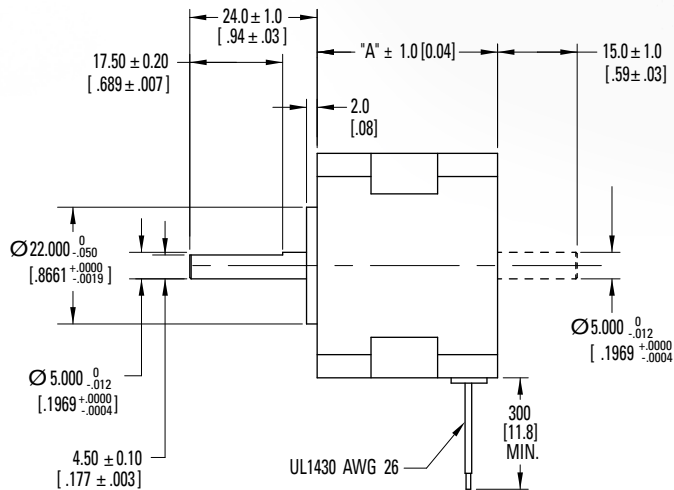

Encoder Mounting Hole Option

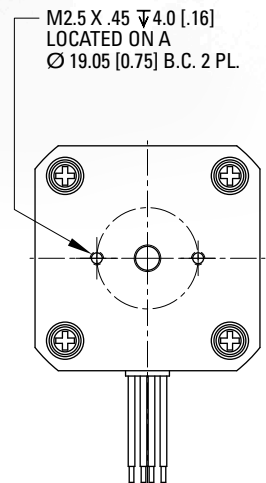

Integral Connector Option

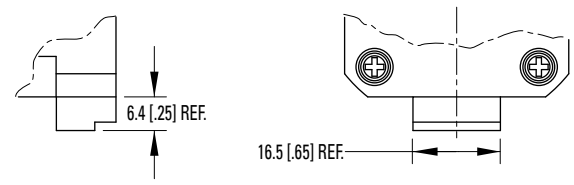

A 4-lead Bipolar, 12 inch (300 mm) mating cable assembly is included for all motors ordered with Integral Connector option.

Model	"A" MAX
PMX171	26 [1.02]
PMX172	33.5 [1.32]
PMX173	39.5 [1.56]
PMX174	47.5 [1.87]
PMX175	60 [2.36]

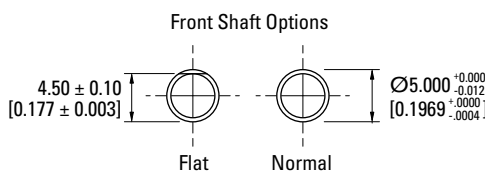

PMX17 (1.8° Step) Performance Data

PMX17			Configuration		Holding Torque (2 phases on) oz-in [Nm] +/-12%	Rated Current/ Phase Amps DC	Phase Resistance Ohms +/-10%	Phase Inductance mH Typical	Thermal Resistance Mounted °C/Watt	Rotor Inertia oz-in-s ² [kg-m ²]	Weight lb [kg]	Shaft Loading	
Stack	Winding	Step	Bipolar	Unipolar								Radial Force lb [N]	Axial Force lb [N]
1	A	1	•		28.4 [0.201]	0.39	24.80	31.09	7.98	2.84E-04 [2.01E-06]	0.3 [0.15]	6.30 [28.0]	2.25 [10.0]
1	B	1	•		27.0 [0.191]	0.69	7.74	8.35					
2	A	1	•		39.2 [0.277]	1.48	2.00	2.56	7.00	4.97E-04 [3.51E-06]	0.5 [0.22]	6.30 [28.0]	2.25 [10.0]
2	B	1	•		38.0 [0.268]	1.00	4.25	5.13					
2	H	1	•		39.5 [0.279]	0.31	44.78	60.73					
2	H	1		•	27.9 [0.197]	0.43	22.37	15.18					
2	J	1	•		39.8 [0.281]	0.74	7.76	10.65					
2	J	1		•	28.1 [0.199]	1.04	3.86	2.66					
3	A	1	•		60.2 [0.425]	1.60	1.74	3.16	6.92	7.67E-04 [5.42E-06]	0.6 [0.28]	6.30 [28.0]	2.25 [10.0]
3	B	1	•		60.1 [0.424]	1.52	1.92	3.48					
3	G	1	•		58.4 [0.412]	0.26	62.75	109.85					
3	G	1		•	41.3 [0.292]	0.37	31.35	27.46					
3	H	1	•		58.8 [0.415]	0.55	13.92	24.74					
3	H	1		•	41.6 [0.294]	0.78	6.94	6.19					
3	J	1	•		60.5 [0.427]	0.80	6.64	12.62					
3	J	1		•	42.8 [0.302]	1.14	3.30	3.16					
4	A	1	•		76.0 [0.537]	1.71	1.82	2.98	5.77	9.66E-04 [6.82E-06]	0.8 [0.35]	6.30 [28.0]	2.25 [10.0]
4	B	1	•		75.7 [0.535]	2.17	1.16	1.83					
4	G	1	•		78.1 [0.552]	0.30	57.16	105.47					
4	G	1		•	55.2 [0.390]	0.42	28.56	26.37					
4	H	1	•		70.7 [0.499]	0.57	15.91	22.67					
4	H	1		•	50.0 [0.353]	0.80	7.93	5.67					
4	J	1	•		70.9 [0.501]	0.85	7.08	10.08					
4	J	1		•	50.1 [0.354]	1.20	3.52	2.52					
5	A	1	•		102.2 [0.722]	1.02	5.87	12.28	4.78	1.45E-03 [1.02E-05]	1.1 [0.50]	6.30 [28.0]	2.25 [10.0]
5	B	1	•		103.2 [0.729]	1.76	2.02	4.26					
5	G	1	•		107.1 [0.756]	0.73	11.67	27.62					
5	G	1		•	75.7 [0.535]	1.03	5.81	6.90					

Notes:

1. All ratings typical and at 40° C unless otherwise noted.
2. Rated current is T = 80° C, ON-PLATE; motor mounted to square aluminum plate heatsink, 2.5X motor diameter, 5mm thick.
3. Small signal inductance as measured with impedance bridge @ 1 KHz, 1 amp.

PMX17 Series Stepper Motors

PMX17 (0.9° Step) Performance Data

PMX17			Configuration		Holding Torque (2 phases on)	Rated Current/ Phase	Phase Resistance	Phase Inductance	Thermal Resistance	Rotor Inertia	Weight	Shaft Loading	
Stack	Winding	Step	Bipolar	Unipolar								Radial Force	Axial Force
					oz-in [Nm] +/-12%	Amps DC	Ohms +/-10%	mH Typical	Mounted °C/Watt	oz-in-s ² [kg-m ²]	lb [kg]	lb [N]	lb [N]
2	A	9	•		38.1 [0.269]	1.41	2.20	5.69	7.00	4.97E-04 [3.51E-06]	0.5 [0.22]	6.30 [28.0]	2.25 [10.0]
2	B	9	•		36.0 [0.254]	1.00	4.25	9.02					
2	H	9	•		36.4 [0.257]	0.44	21.49	48.70					
2	H	9		•	25.7 [0.182]	0.62	10.73	12.18					
3	A	9	•		55.9 [0.395]	1.60	1.74	4.50	6.92	7.67E-04 [5.42E-06]	0.6 [0.28]	6.30 [28.0]	2.25 [10.0]
3	B	9	•		55.8 [0.394]	1.52	1.92	4.96					
3	H	9	•		56.8 [0.401]	0.52	15.65	44.61					
3	H	9		•	40.2 [0.284]	0.74	7.81	11.15					
4	A	9	•		68.6 [0.484]	1.67	1.91	5.99	5.77	9.66E-04 [6.82E-06]	0.8 [0.35]	6.30 [28.0]	2.25 [10.0]
4	B	9	•		67.5 [0.477]	2.17	1.16	3.31					
4	G	9	•		70.2 [0.496]	0.29	61.31	177.65					
4	G	9		•	49.2 [0.348]	0.41	30.64	44.41					

Notes:

1. All ratings typical and at 40° C unless otherwise noted.
2. Rated current is T = 90° C, ON-PLATE; motor mounted to square aluminum plate heatsink, 2.5X motor diameter, 5mm thick.
3. Small signal inductance as measured with impedance bridge @ 1 KHz, 1 amp.
4. Complete PMX series model nomenclature can be found on page 52.

PMX17 Series (Bipolar - 1.8° Step) Performance Curves

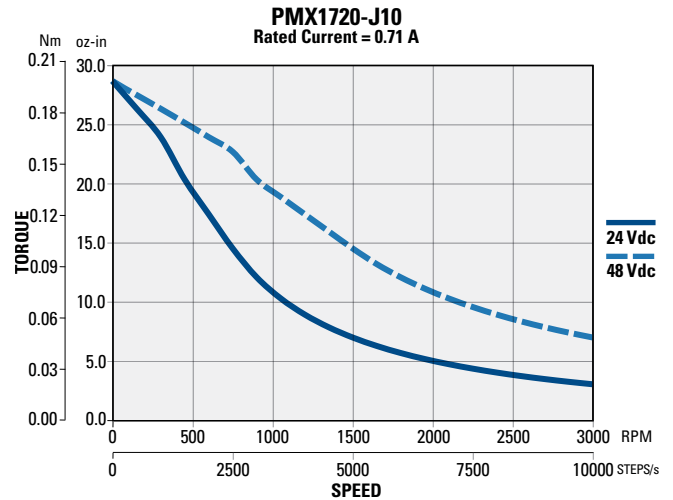
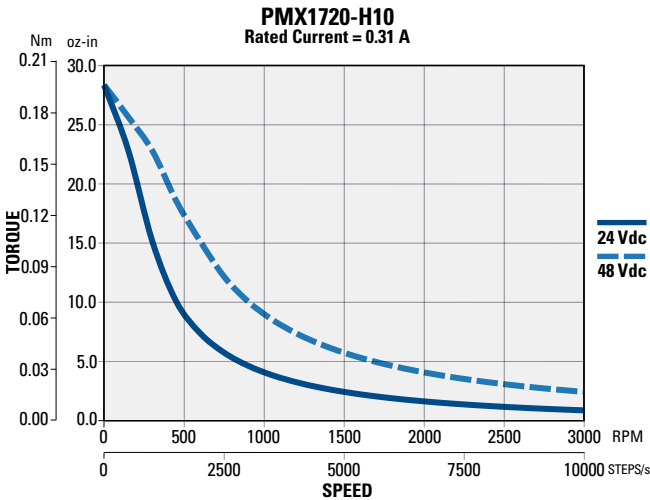
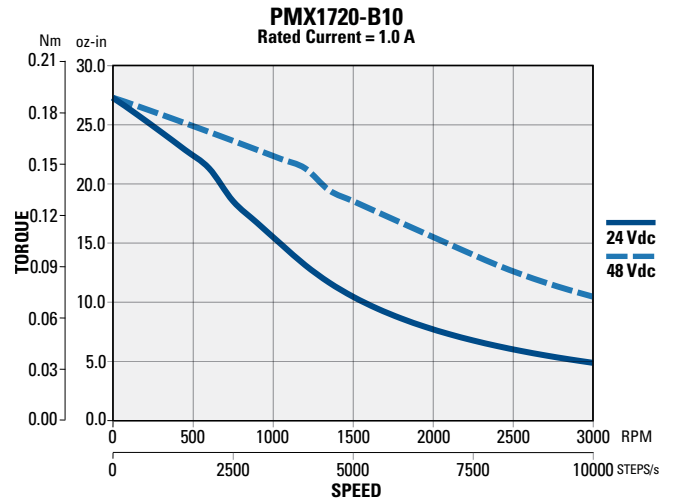
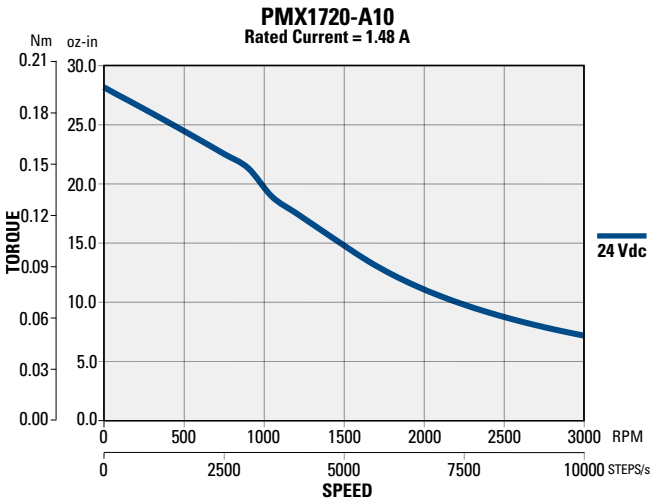
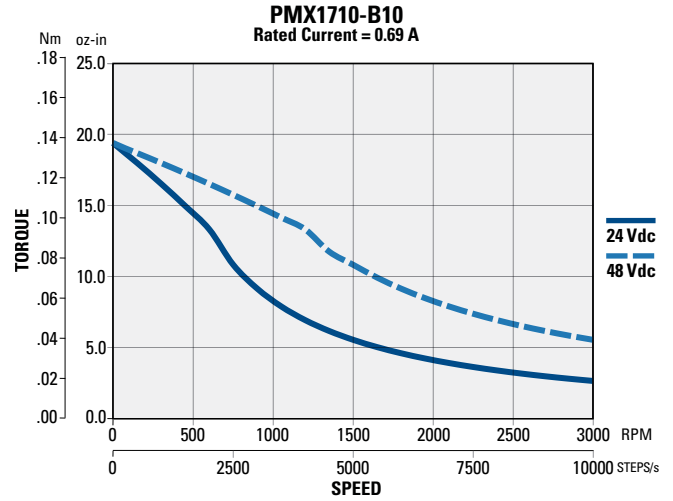
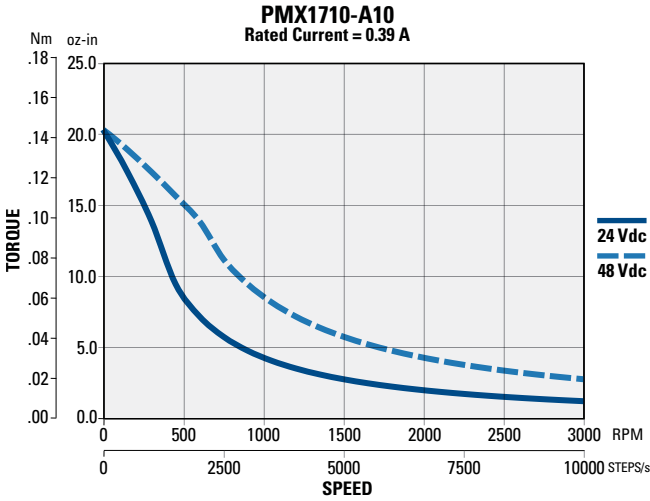

PMX17 Series Stepper Motors

PMX17 Series (Bipolar - 1.8° Step) Performance Curves

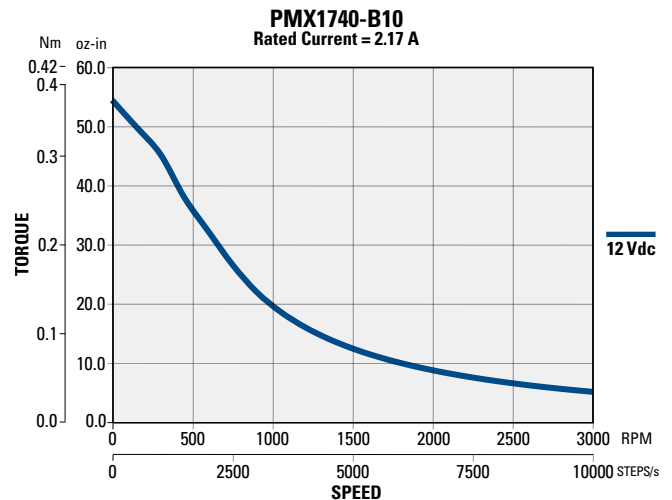
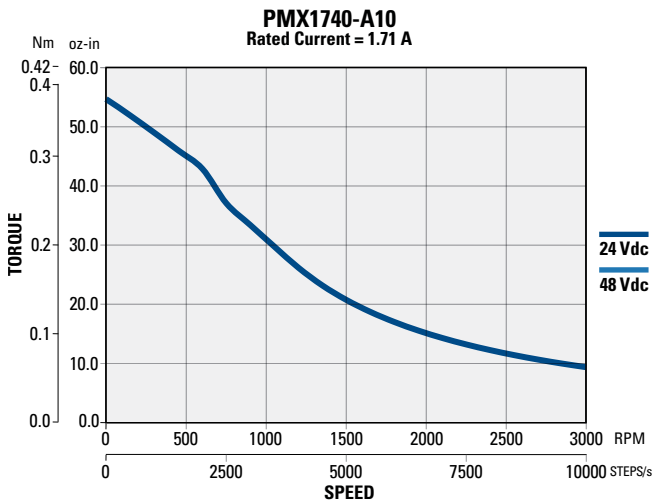
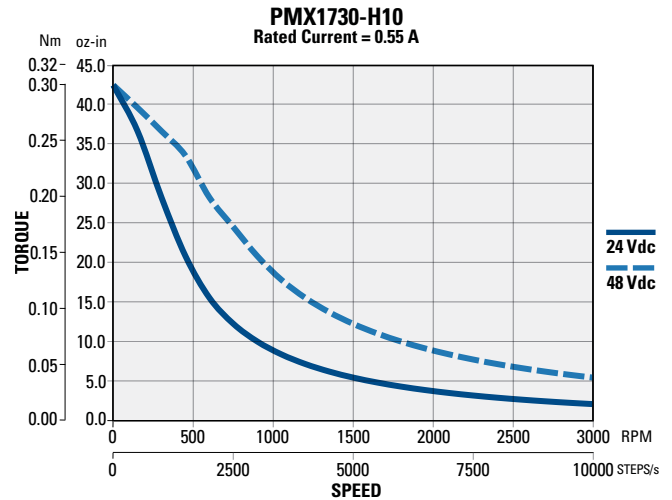
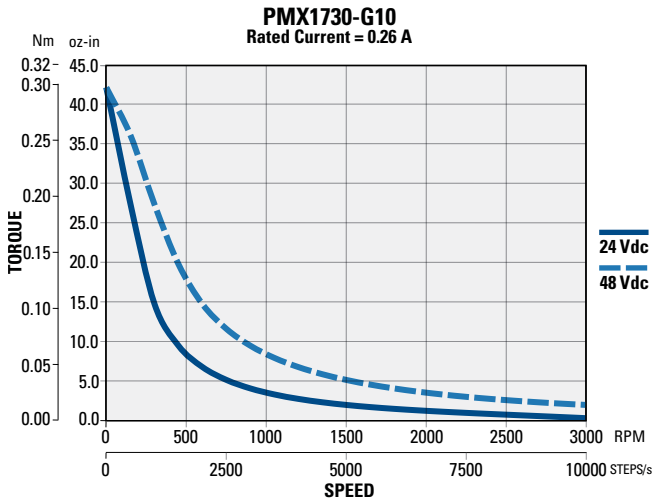
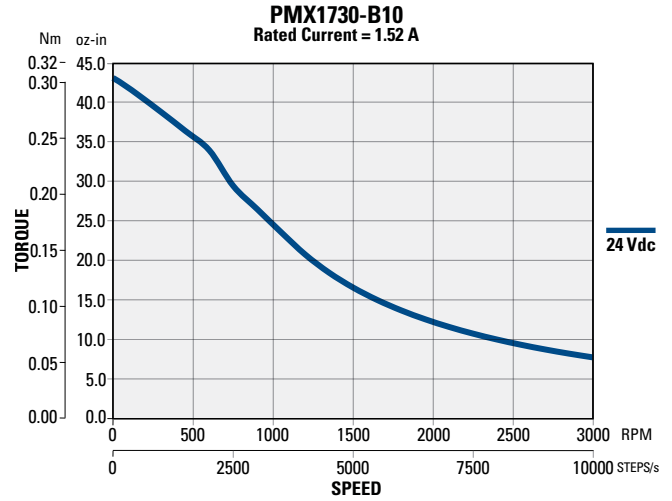
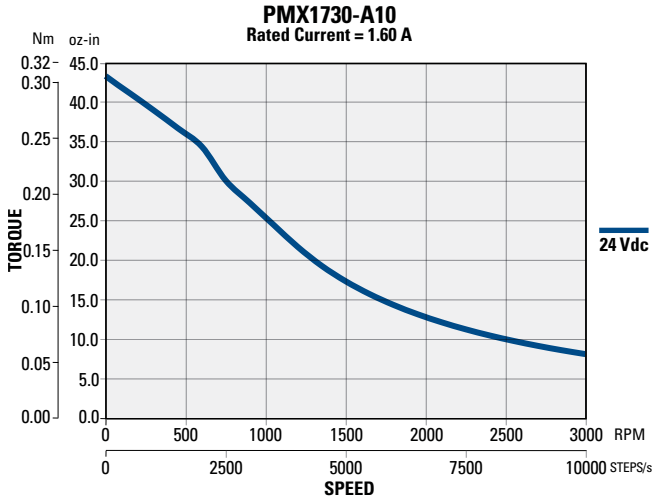

PMX17 Series (Bipolar - 1.8° Step) Performance Curves

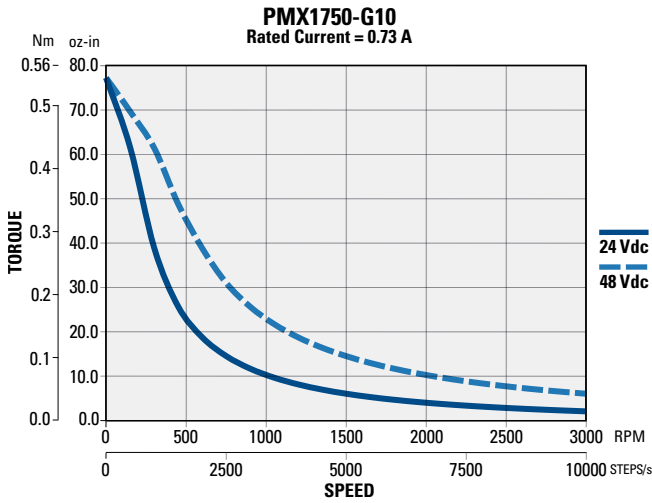
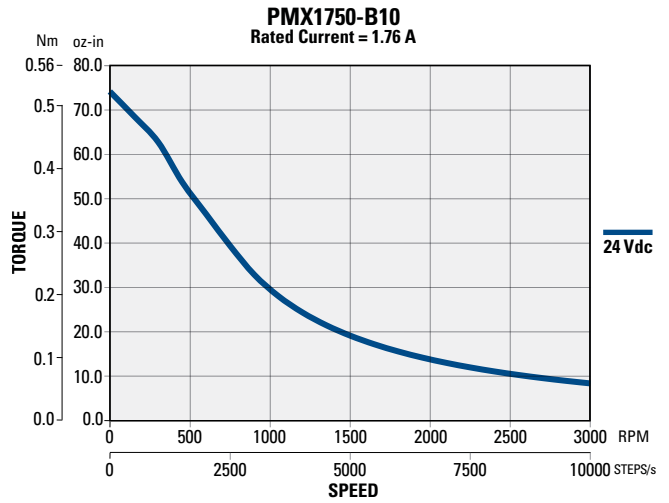
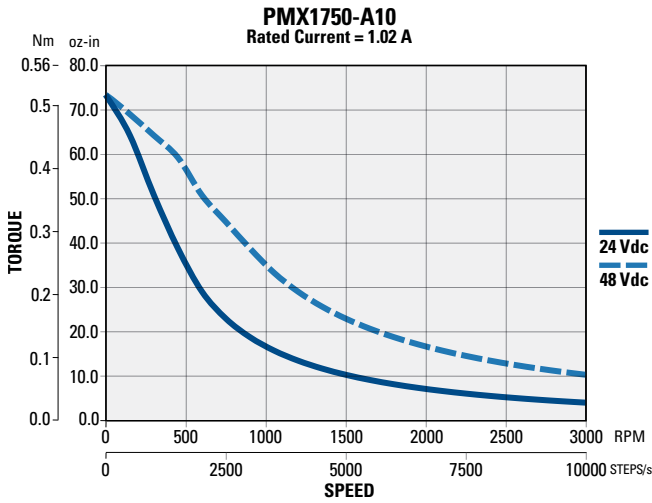
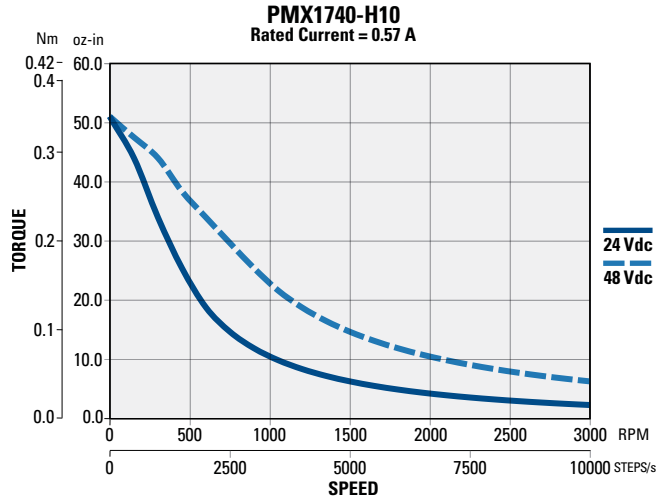
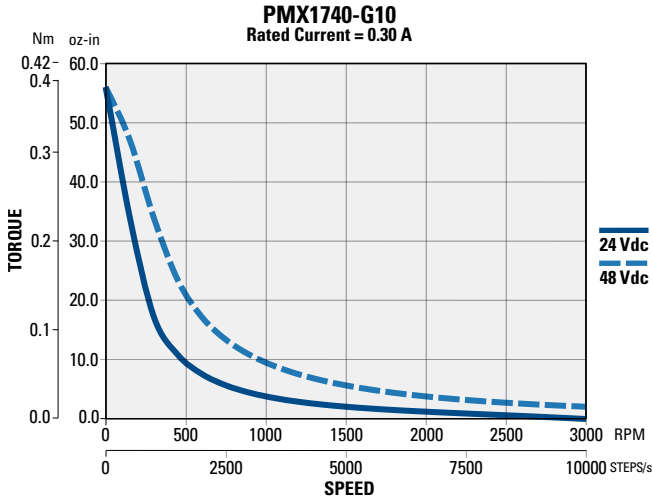

PMX17 Series Stepper Motors

PMX17 Series (Bipolar - 0.9° Step) Performance Curves

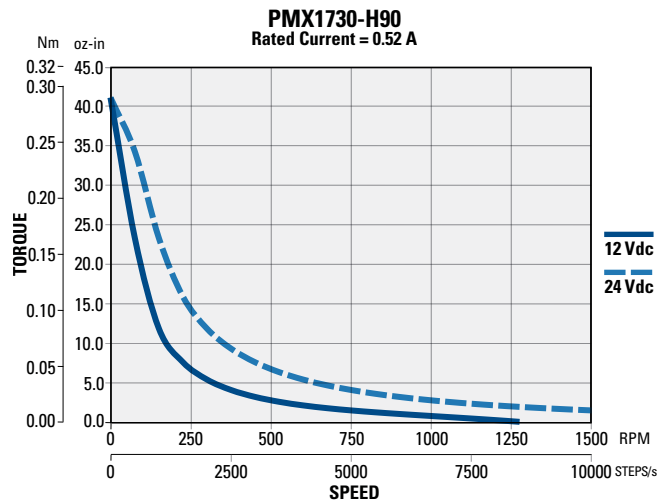
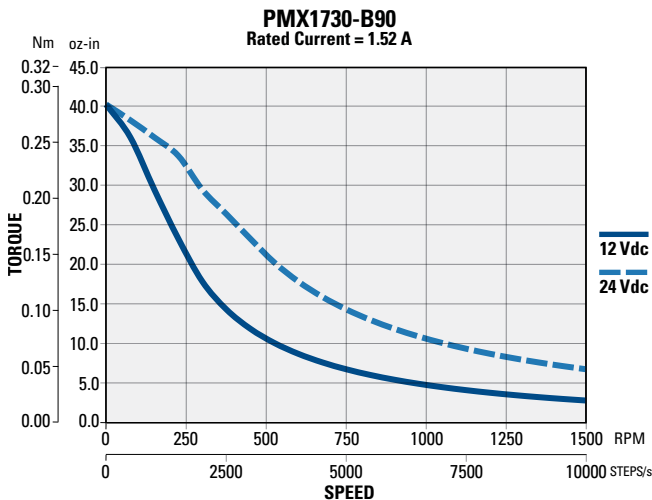
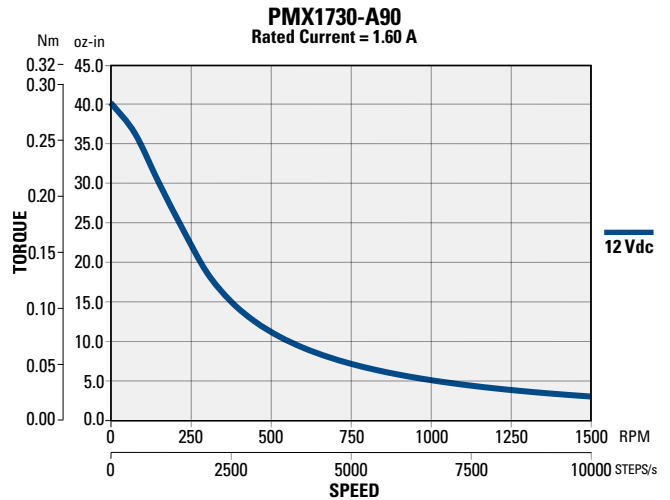
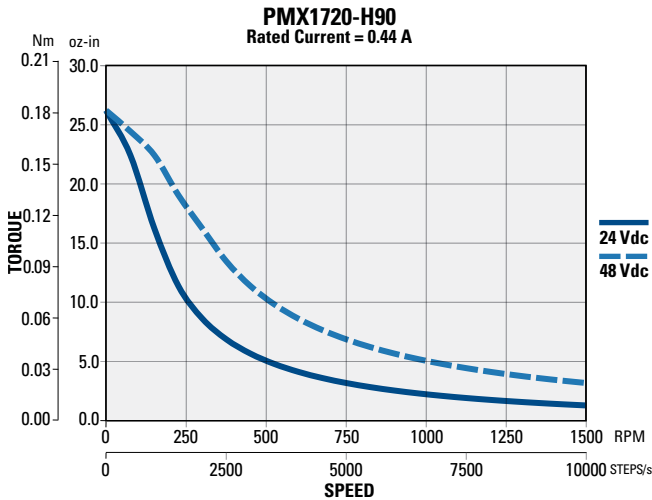
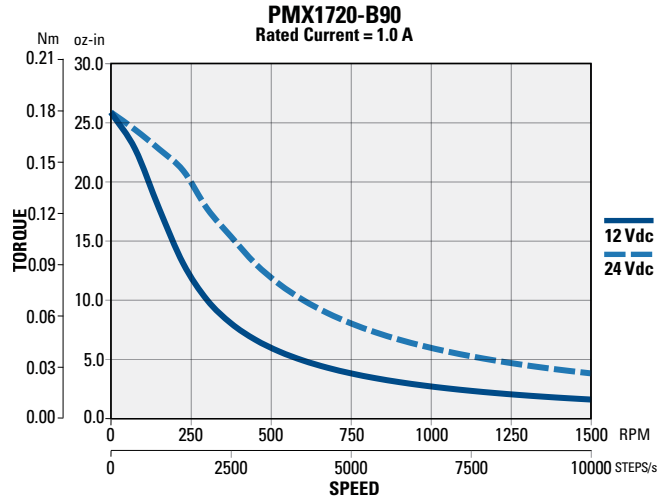
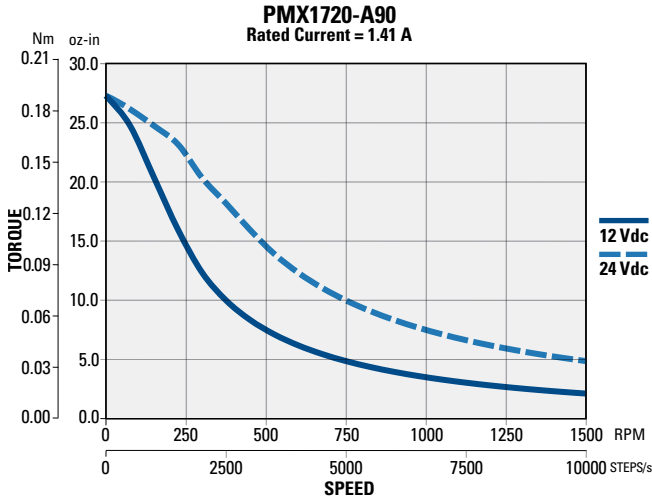

PMX17 Series (Bipolar - 0.9° Step) Performance Curves

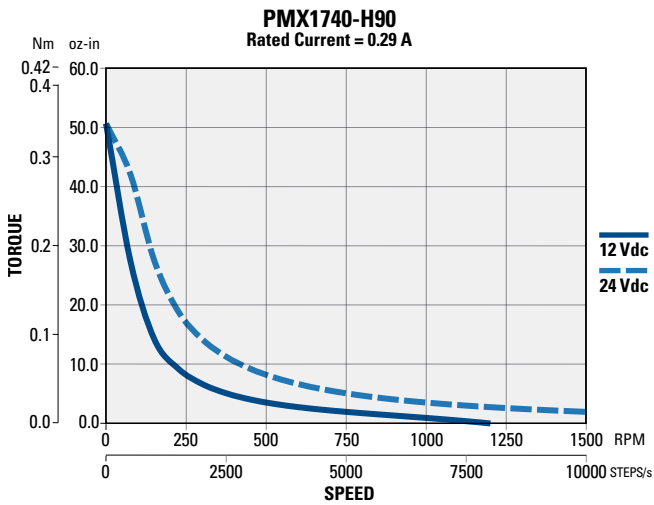
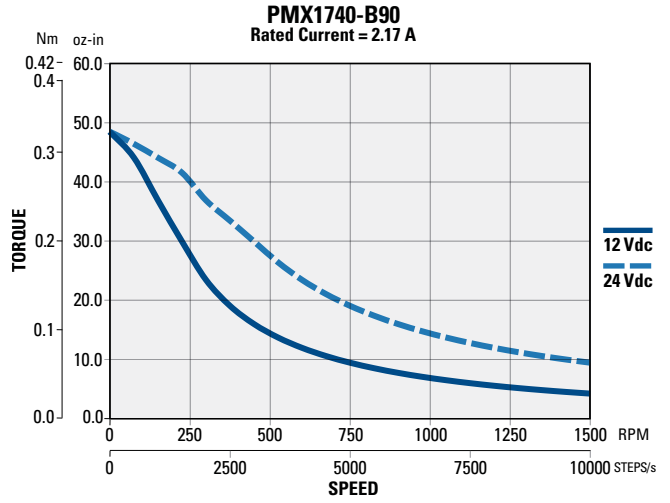
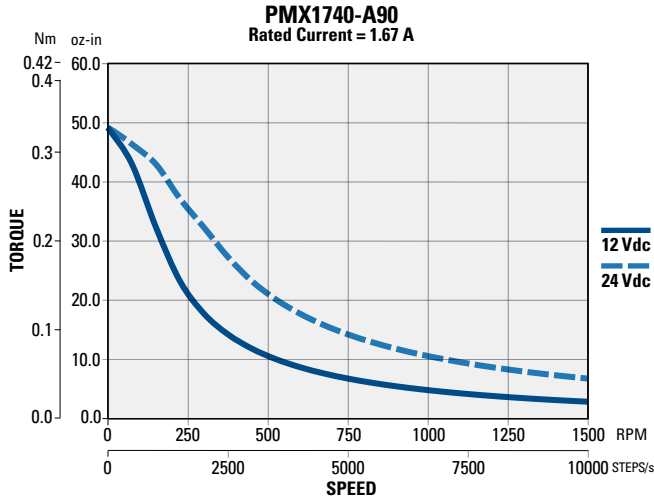

PMX23 Series Stepper Motors

PMX23 Standard Options and Specifications

- NEMA Size 23
- Front shaft flat option
- Rear shaft option
- Integral connector option
- Rear encoder mounting holes
- Bipolar and Unipolar windings

Phases	2
Full Steps Per Revolution	200
Step Size Angle	1.8°, 0.9°
Step Angle Accuracy %	+/- 5.0
Maximum Case Temperature	130° C
Insulation Class	NEMA Class B, 130 °C
Insulation Resistance	100 Megaohms @ 500 Vdc
Ambient Temperature	-20.0 to + 40.0 °C
Dielectric Strength	500 Vac, 1 minute
Certifications:	CE, RoHS, REACH compliant

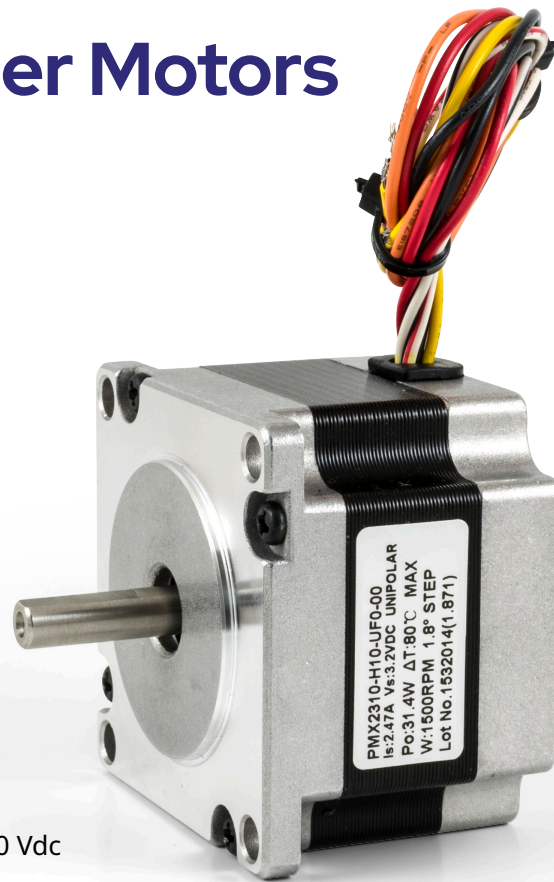

PMX23 Dimensions

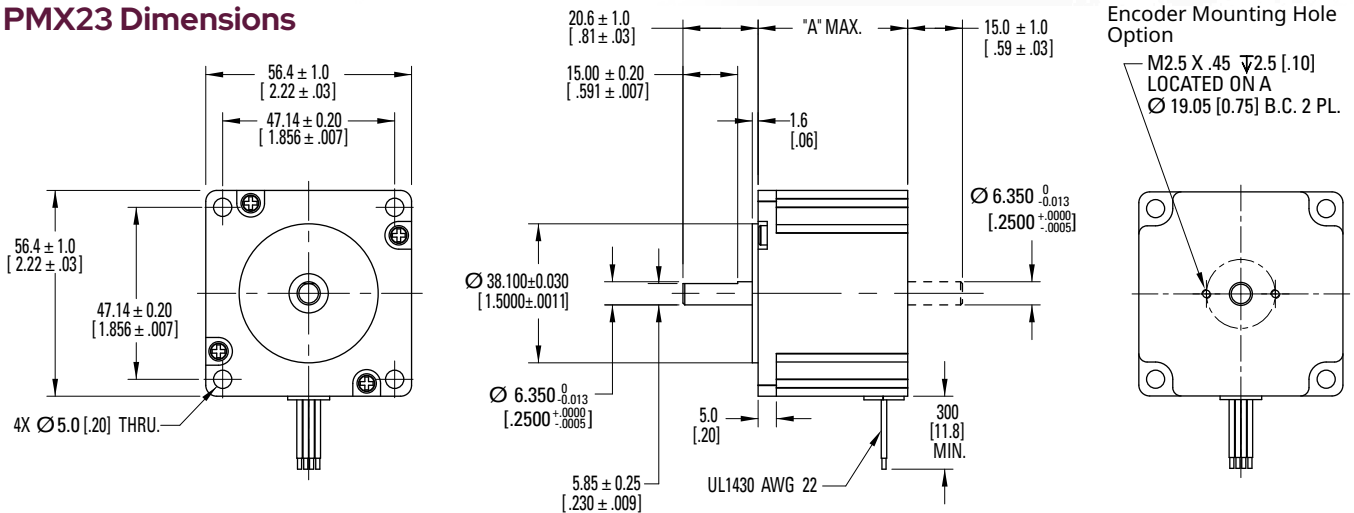

Model	"A" MAX
PMX231	41 [1.61]
PMX232	56 [2.20]
PMX233	76 [2.99]
PMX234	85 [3.35]

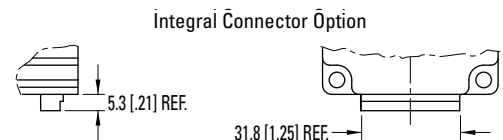
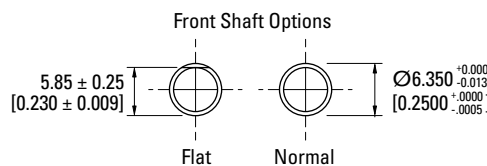

A 4-lead Bipolar, 12 inch (300 mm) mating cable assembly is included for all motors ordered with Integral Connector option.

Dimensions in mm [inches]

PMX23 (1.8° Step) Performance Data

PMX23			Configuration		Holding Torque (2 phases on)	Rated Current/ Phase	Phase Resistance	Phase Inductance	Thermal Resistance	Rotor Inertia	Weight	Shaft Loading	
Stack	Winding	Step	Bipolar	Unipolar	oz-in [Nm] +/-12%	Amps DC	Ohms +/-10%	mH Typical	Mounted °C/Watt	oz-in-s ² [kg-m ²]	lb [kg]	Radial Force lb [N]	Axial Force lb [N]
1	A	1	•		100.7 [0.711]	3.50	0.68	1.33	4.69	1.70E-03 [1.20E-05]	1.0 [0.45]	16.88 [75.0]	3.38 [15.0]
1	B	1	•		98.9 [0.698]	0.48	34.78	59.94					
1	C	1	•		95.8 [0.676]	1.27	4.94	8.93					
1	G	1	•		100.4 [0.709]	0.87	10.48	21.33					
1	G	1		•	71.0 [0.501]	1.23	5.23	5.33					
1	H	1	•		100.7 [0.711]	1.75	2.62	5.33					
1	H	1		•	71.2 [0.503]	2.47	1.31	1.33					
1	J	1	•		102.3 [0.722]	2.53	1.27	2.66					
1	J	1		•	72.3 [0.511]	3.58	0.63	0.67					
2	A	1	•		205.2 [1.449]	3.45	0.83	2.63	3.11	4.26E-03 [3.01E-05]	1.5 [0.70]	16.88 [75.0]	3.38 [15.0]
2	B	1	•		196.5 [1.388]	0.56	30.23	88.58					
2	C	1	•		198.9 [1.405]	1.24	6.20	18.73					
2	G	1	•		199.9 [1.412]	0.84	13.25	40.74					
2	G	1		•	141.4 [0.999]	1.19	6.62	10.19					
2	H	1	•		208.4 [1.472]	1.76	3.06	10.53					
2	H	1		•	147.4 [1.041]	2.49	1.52	2.63					
2	J	1	•		204.3 [1.443]	2.57	1.46	4.68					
2	J	1		•	144.5 [1.020]	3.63	0.72	1.17					

Continued on the following page

Notes:

1. All ratings typical and at 40° C unless otherwise noted.
2. Rated current is T = 80° C, ON-PLATE; motor mounted to square aluminum plate heatsink, 2.5X motor diameter, 5mm thick.
3. Small signal inductance as measured with impedance bridge @ 1 KHz, 1 amp.

PMX23 Series Stepper Motors

PMX23 (1.8° Step) Performance Data (continued)

PMX23			Configuration		Holding Torque (2 phases on) oz-in [Nm] +/-12%	Rated Current/ Phase Amps DC	Phase Resistance Ohms +/-10%	Phase Inductance mH Typical	Thermal Resistance Mounted °C/Watt	Rotor Inertia oz-in-s ² [kg-m ²]	Weight lb [kg]	Shaft Loading	
Stack	Winding	Step	Bipolar	Unipolar								Radial Force lb [N]	Axial Force lb [N]
3	A	1	•		326.4 [2.305]	3.23	1.14	3.75	2.70	6.82E-03 [4.82E-05]	2.2 [1.00]	16.88 [75.0]	3.38 [15.0]
3	B	1	•		336.8 [2.378]	3.96	0.73	2.57					
3	G	1	•		320.2 [2.261]	0.80	16.81	53.95					
3	G	1		•	226.6 [1.600]	1.14	8.39	13.47					
3	H	1	•		326.4 [2.305]	1.57	4.45	15.00					
3	H	1		•	230.8 [1.630]	2.21	2.22	3.75					
3	J	1	•		327.4 [2.312]	2.40	1.92	6.44					
3	J	1		•	231.5 [1.635]	3.40	0.95	1.61					
4	A	1	•		378.4 [2.672]	3.83	0.81	3.23	2.52	7.38E-03 [5.21E-05]	2.6 [1.20]	16.88 [75.0]	3.38 [15.0]
4	B	1	•		347.5 [2.454]	0.75	20.81	67.27					
4	C	1	•		349.3 [2.467]	1.16	8.66	28.34					
4	D	1	•		354.0 [2.500]	0.99	11.82	40.08					

Notes:

1. All ratings typical and at 40° C unless otherwise noted.
2. Rated current is T = 80° C, ON-PLATE; motor mounted to square aluminum plate heatsink, 2.5X motor diameter, 5mm thick.
3. Small signal inductance as measured with impedance bridge @ 1 KHz, 1 amp.
4. Complete PMX series model nomenclature can be found on page 52.

PMX **23** **2** **0** - **A** **1** **0** - **B** **N** **0** - **00**
 Motor Series Frame Size Stack Length Winding Step Angle Connection Front Shaft Opt. Rear Shaft Opt.

PMX23 (0.9° Step) Performance Data

PMX23			Configuration		Holding Torque (2 phases on)	Rated Current/ Phase	Phase Resistance	Phase Inductance	Thermal Resistance	Rotor Inertia	Weight	Shaft Loading	
Stack	Winding	Step	Bipolar	Unipolar	oz-in [Nm] +/-12%	Amps DC	Ohms +/-10%	mH Typical	Mounted °C/Watt	oz-in-s ² [kg-m ²]	lb [kg]	Radial Force lb [N]	Axial Force lb [N]
1	A	9	•		97.6 [0.689]	3.37	0.74	2.66	4.69	1.70E-03 [1.20E-05]	1.0 [0.45]	16.88 [75.0]	3.38 [15.0]
1	B	9	•		92.5 [0.653]	0.47	35.54	106.70					
1	C	9	•		93.7 [0.662]	1.26	5.05	15.89					
1	G	9	•		97.4 [0.688]	0.86	10.66	37.95					
1	G	9		•	68.1 [0.481]	1.22	5.22	9.48					
2	A	9	•		203.8 [1.439]	3.24	0.93	5.15	3.11	4.26E-03 [3.01E-05]	1.5 [0.70]	16.88 [75.0]	3.38 [15.0]
2	B	9	•		195.1 [1.378]	0.56	29.59	124.49					
2	C	9	•		196.9 [1.390]	1.25	6.07	26.32					
2	G	9	•		204.8 [1.446]	0.80	14.94	87.46					
2	G	9		•	146.8 [1.037]	1.16	7.47	21.87					
3	A	9	•		313.0 [2.210]	3.26	1.06	6.67	2.70	6.82E-03 [4.82E+05]	2.2 [1.00]	16.88 [75.0]	3.38 [15.0]
3	B	9	•		304.5 [2.150]	4.14	0.67	3.75					
3	G	9	•		305.4 [2.157]	0.78	17.85	106.72					
3	G	9		•	216.0 [1.525]	1.10	8.92	26.68					

Notes:

1. All ratings typical and at 40° C unless otherwise noted.
2. Rated current is T = 80° C, ON-PLATE; motor mounted to square aluminum plate heatsink, 2.5X motor diameter, 5mm thick.
3. Small signal inductance as measured with impedance bridge @ 1 KHz, 1 amp.

PMX23 Series Stepper Motors

PMX23 Series (Bipolar - 1.8° Step) Performance Curves

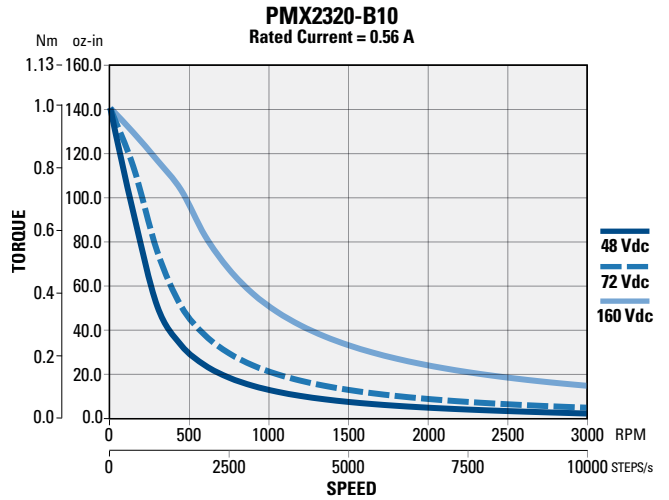
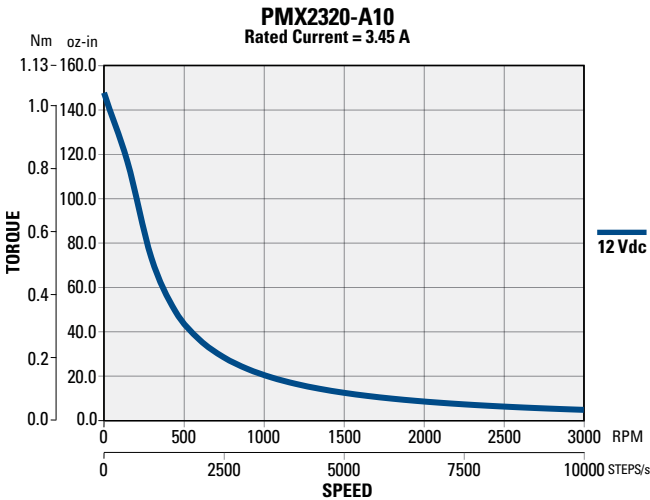
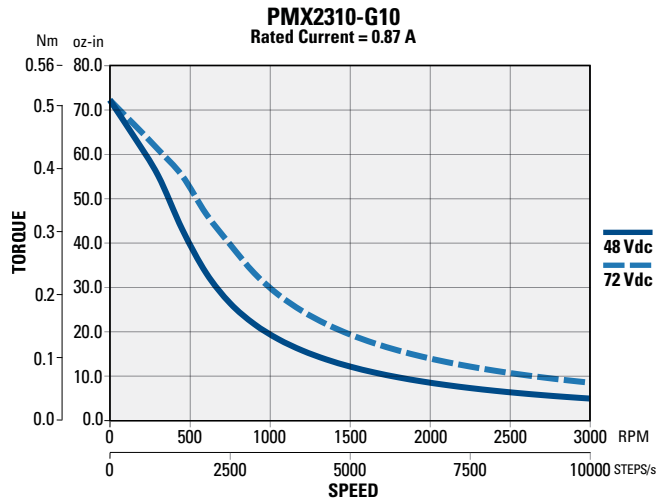
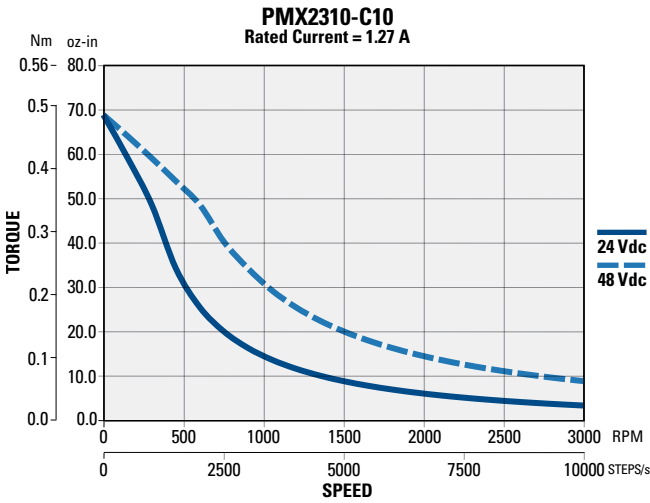
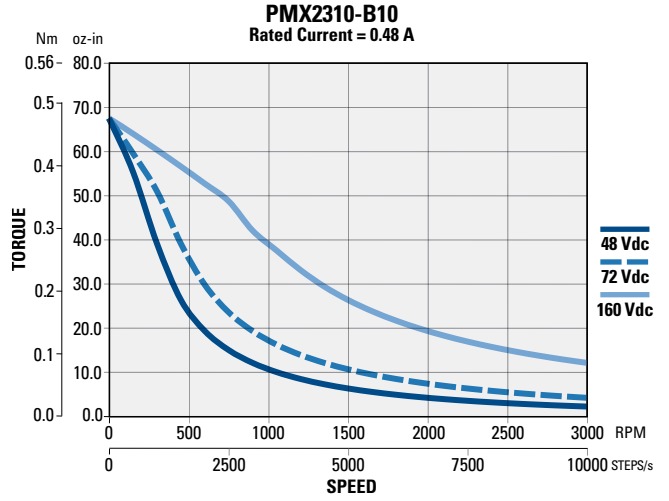
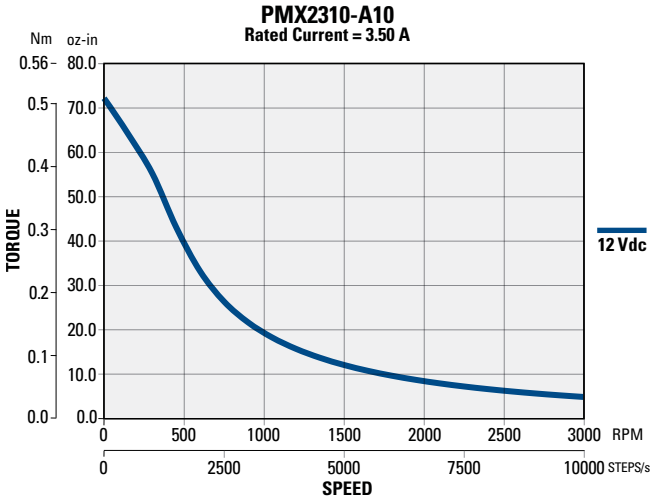

PMX23 Series (Bipolar - 1.8° Step) Performance Curves

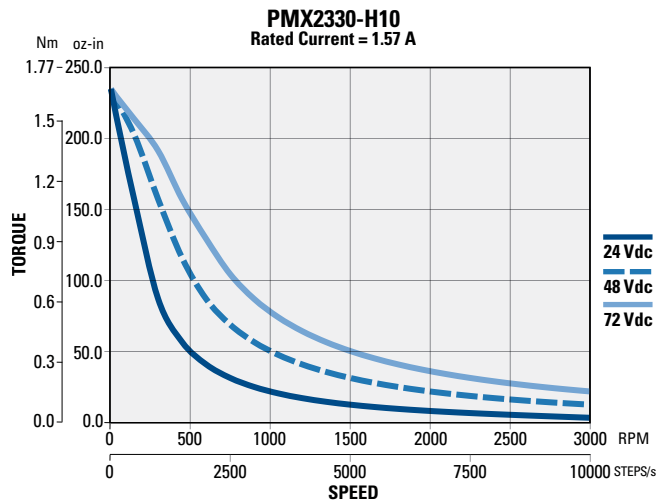
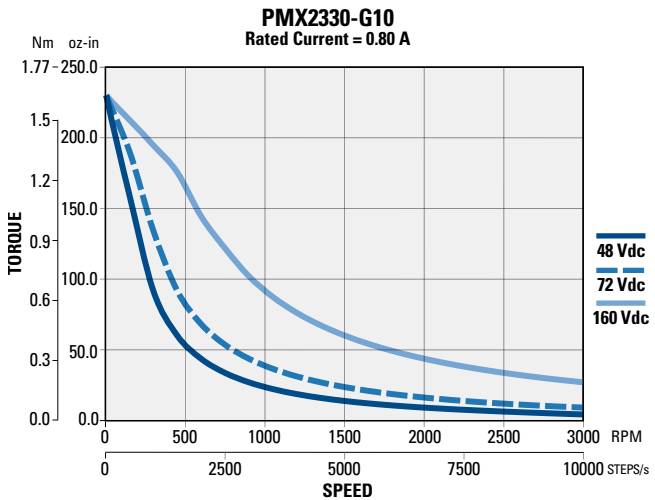
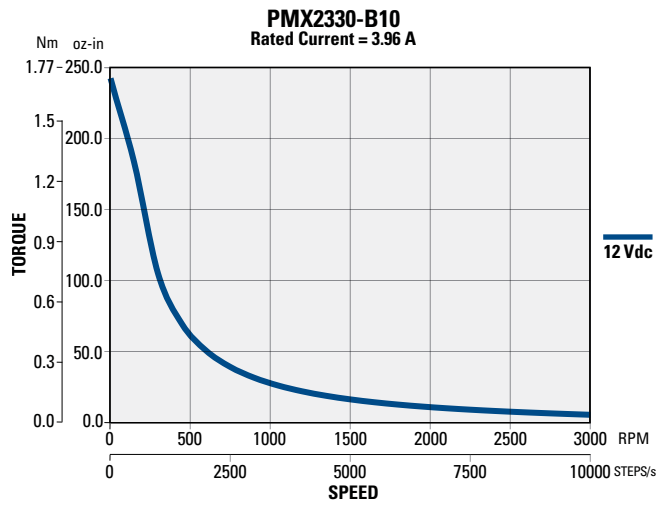
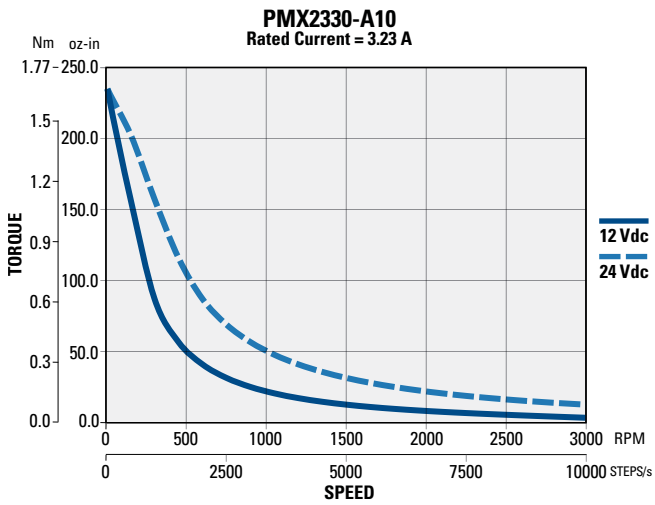
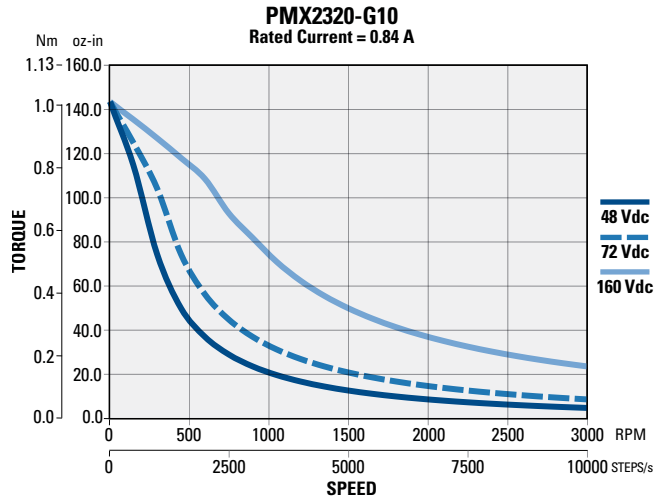
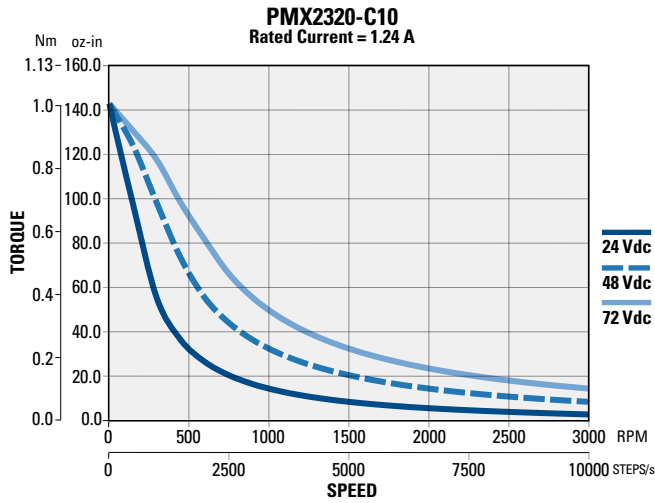

PMX23 Series Stepper Motors

PMX23 Series (Bipolar - 1.8° Step) Performance Curves

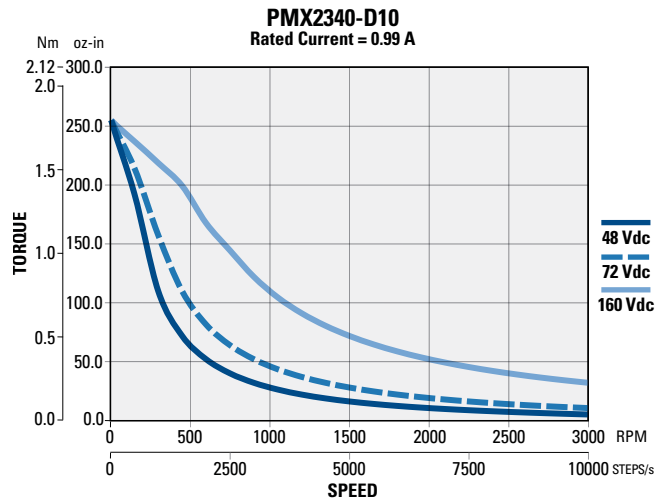
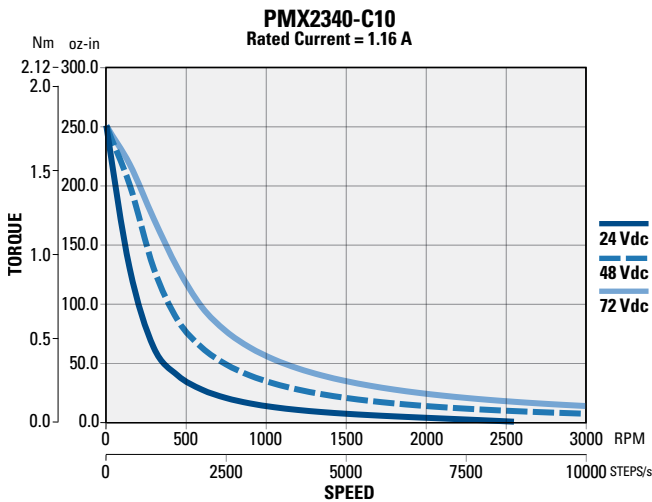
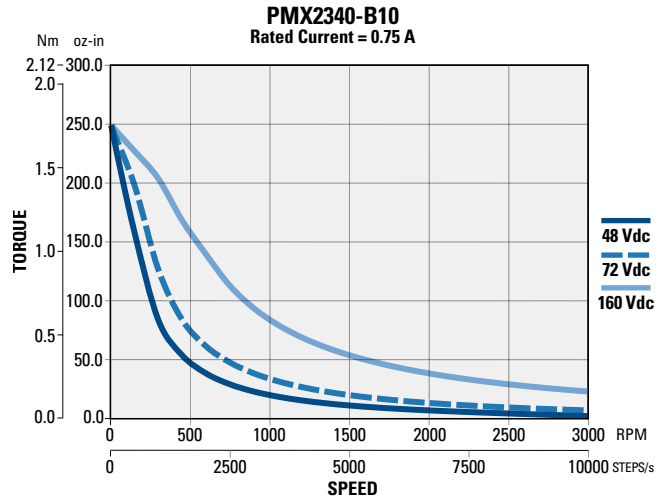
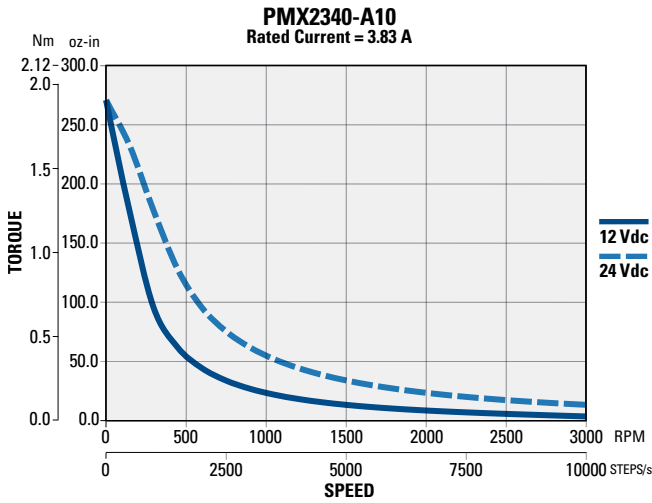

PMX23 Series (Bipolar - 0.9° Step) Performance Curves

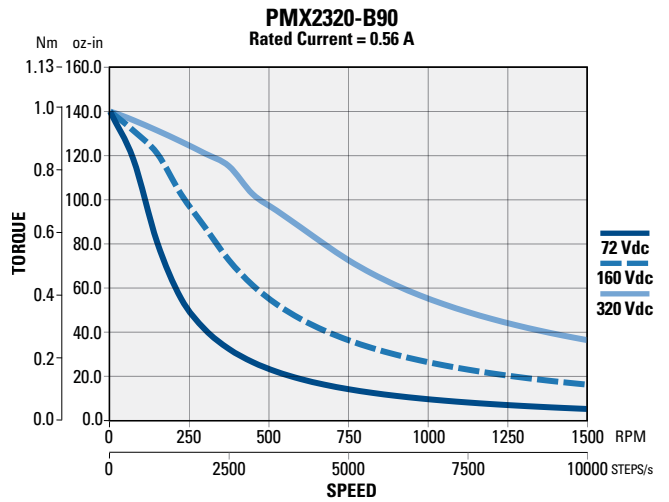
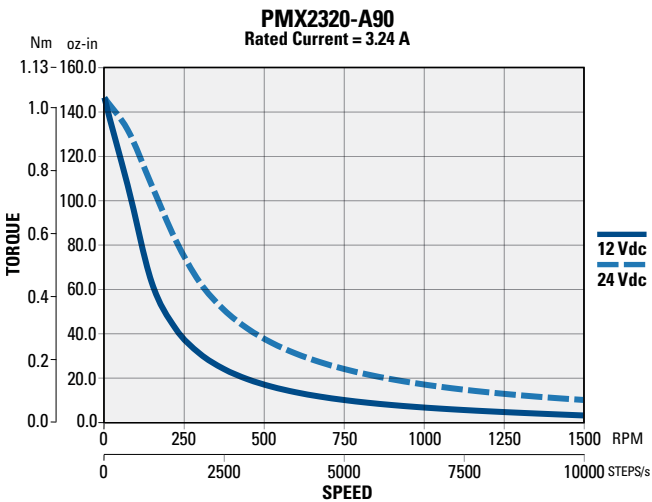
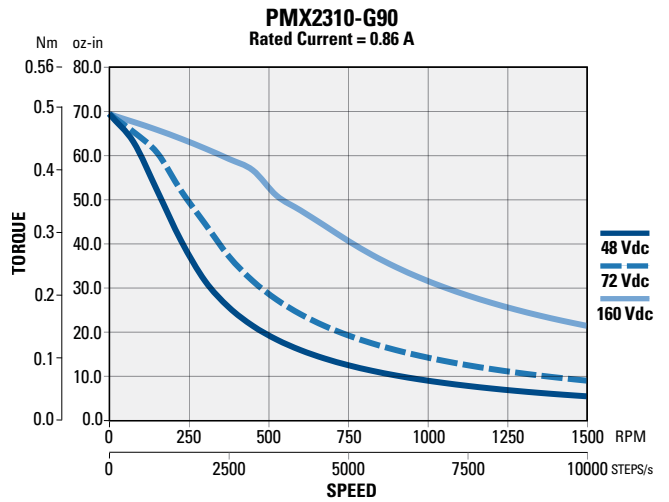
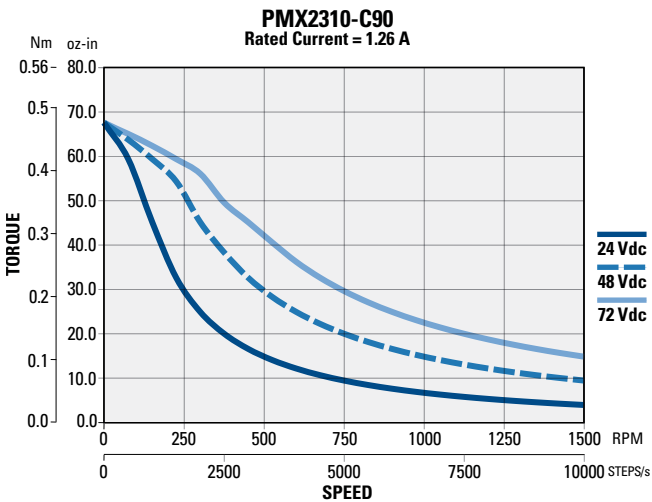
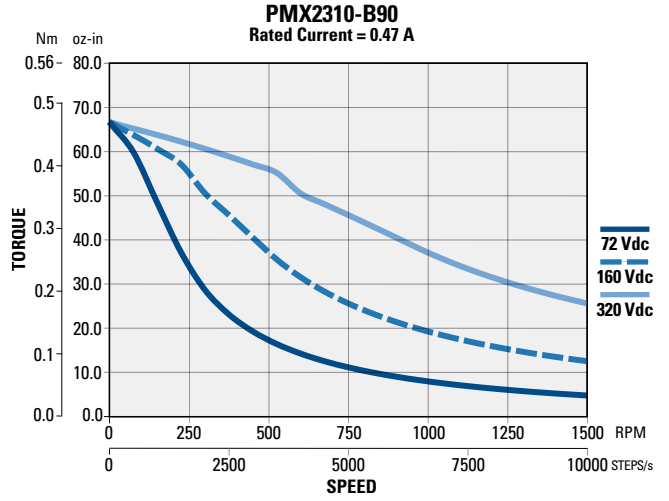
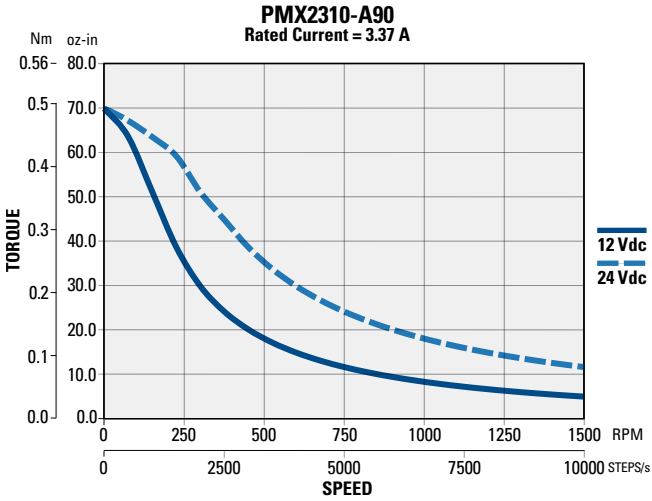

PMX23 Series Stepper Motors

PMX23 Series (Bipolar - 0.9° Step) Performance Curves

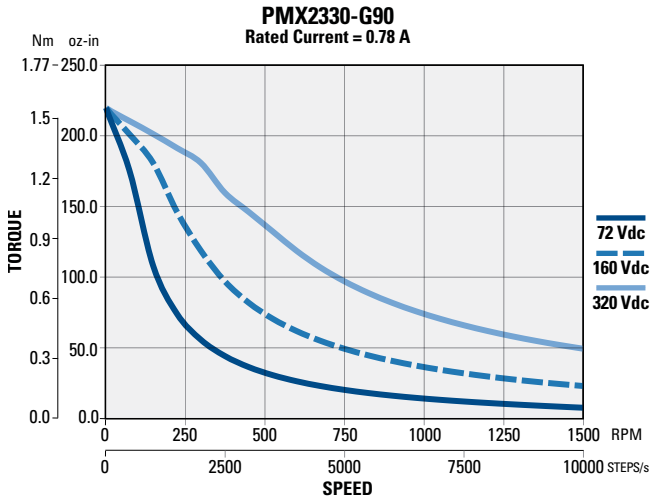
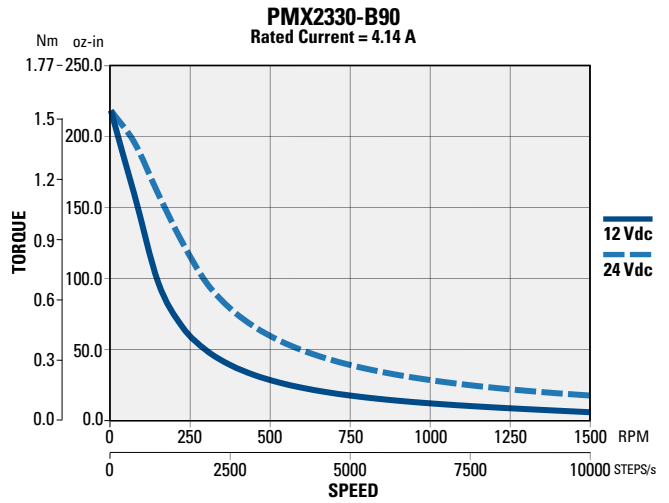
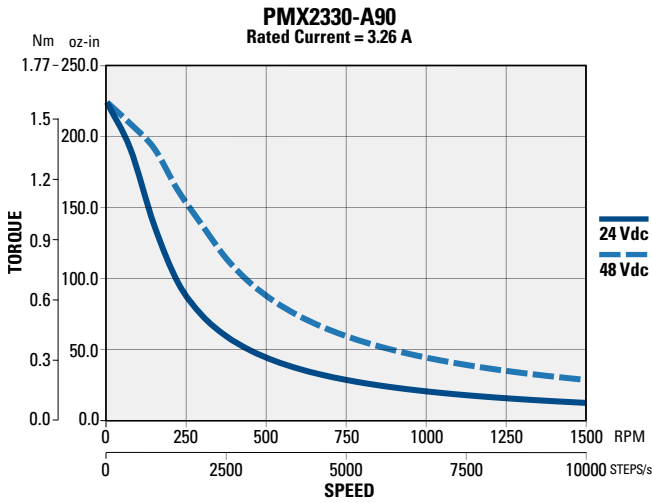
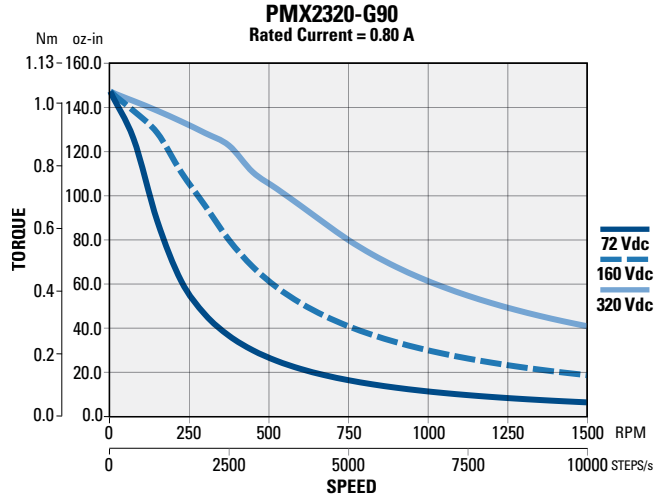
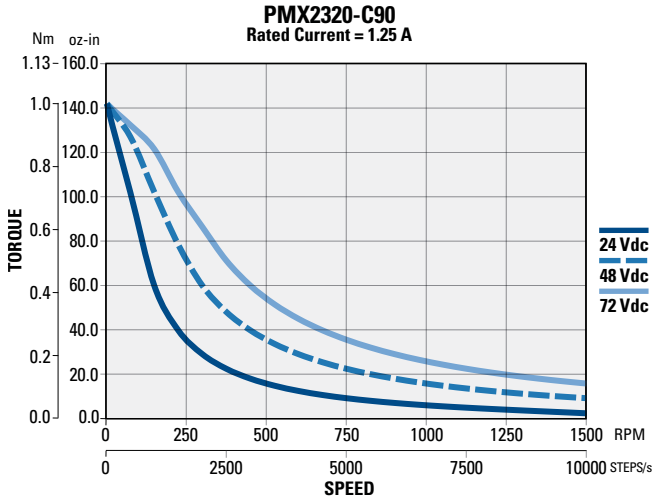

Notes

PMX 23 2 0 - A 1 0 - B N 0 - 00
Motor Series Frame Size Stack Length Winding Step Angle Connection Front Shaft Opt. Rear Shaft Opt.

A large grid area for taking notes, with a 0.125 inch division size.

0.125 inch divisions

PMX34 Series Stepper Motors

PMX34 Standard Options and Specifications

- NEMA Size 34
- Front shaft flat option
- Rear shaft option
- Bipolar windings

Phases	2
Full Steps Per Revolution	200
Step Size Angle	1.8°
Step Angle Accuracy %	+/- 5.0
Maximum Case Temperature	130 °C
Insulation Class	NEMA Class B, 130 °C
Insulation Resistance	100 Megaohms @ 500 Vdc
Ambient Temperature	-20.0 to + 40.0 °C
Dielectric Strength	500 Vac, 1 minute
Certifications:	CE, RoHS, REACH compliant

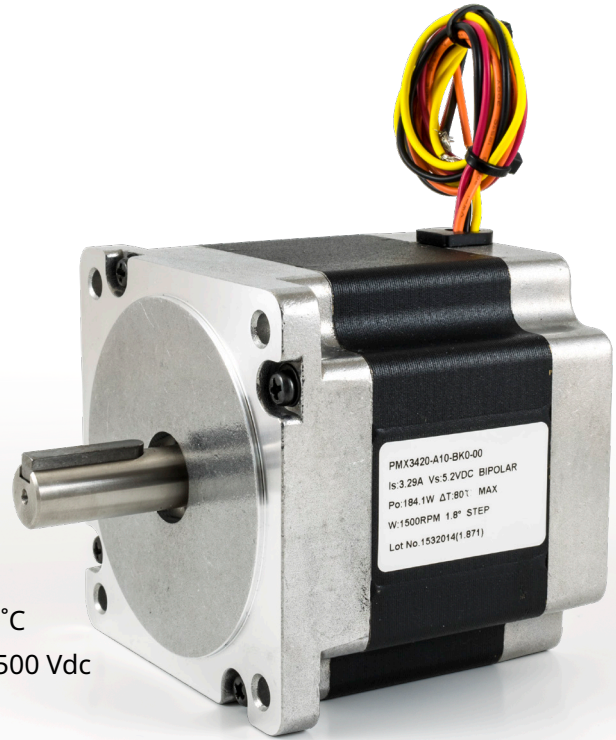

PMX34 Dimensions

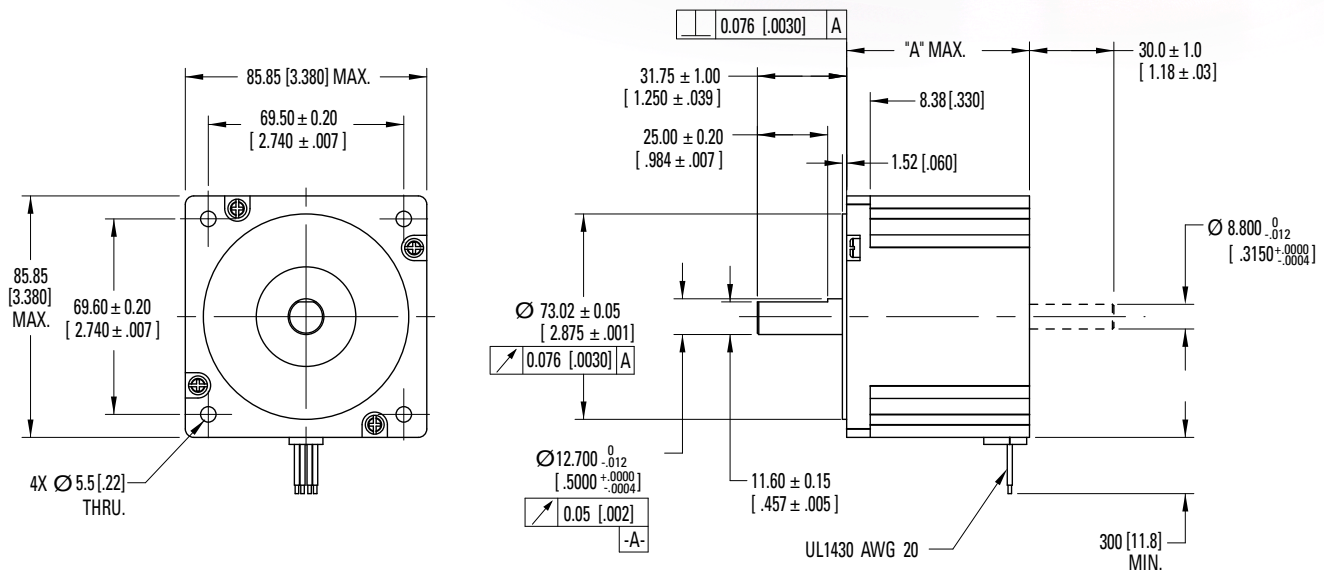

Model	"A" MAX
PMX341	65 [2.56]
PMX342	80 [3.15]
PMX343	118 [4.65]
PMX344	156 [6.14]

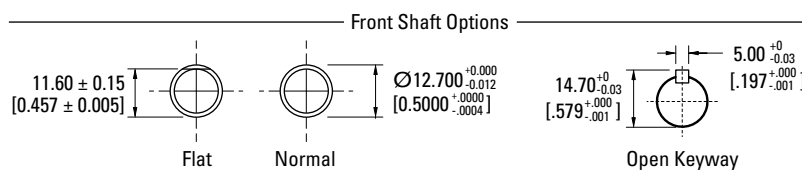

Dimensions in mm [inches]

PMX34 (1.8° Step) Performance Data

PMX34			Configuration		Holding Torque (2 phases on)	Rated Current/ Phase	Phase Resistance	Phase Inductance	Thermal Resistance	Rotor Inertia	Weight	Shaft Loading	
Stack	Winding	Step	Bipolar	Unipolar	oz-in [Nm] +/-12%	Amps DC	Ohms +/-10%	mH Typical	Mounted °C/Watt	oz-in-s ² [kg-m ²]	lb [kg]	lb [N]	lb [N]
1	A	1	•		486.1 [3.433]	3.61	1.15	6.46	1.98	1.42E-02 [1.00E-04]	3.7 [1.70]	49.46 [220]	13.49 [60]
1	B	1	•	486.1 [3.433]	7.22	0.31	1.62						
1	C	1	•	483.1 [3.411]	1.01	14.65	81.70						
1	D	1	•	489.5 [3.457]	2.59	2.21	12.81						
2	A	1	•		695.8 [4.913]	3.26	1.51	12.71	1.83	1.99E-02 [1.41E-04]	5.1 [2.30]	49.46 [220]	13.49 [60]
2	B	1	•	703.5 [4.968]	6.40	0.41	3.41						
2	C	1	•	685.0 [4.837]	1.09	13.56	108.98						
2	D	1	•	698.9 [4.935]	2.87	1.95	16.60						
3	A	1	•		1238.5 [8.746]	3.04	2.34	22.20	1.35	3.83E-02 [2.70E-04]	8.4 [3.79]	49.46 [220]	13.49 [60]
3	B	1	•	1285.4 [9.077]	6.45	0.54	5.56						
3	C	1	•	1223.4 [8.639]	1.23	14.29	151.00						
3	D	1	•	1250.1 [8.828]	4.80	0.95	10.58						
4	A	1	•		1630.7 [11.515]	2.94	3.05	33.14	1.21	5.68E-02 [4.01E-04]	11.7 [5.29]	49.46 [220]	13.49 [60]
4	B	1	•	1739.2 [12.281]	6.00	0.75	8.94						
4	C	1	•	1659.0 [11.715]	1.42	12.93	148.28						
4	D	1	•	1689.0 [11.927]	4.46	1.33	15.88						

Notes:

1. All ratings typical and at 40° C unless otherwise noted.
2. Rated current is T = 80° C, ON-PLATE; motor mounted to square aluminum plate heatsink, 2.5X motor diameter, 5mm thick.
3. Small signal inductance as measured with impedance bridge @ 1 KHz, 1 amp.

PMX34 Series Stepper Motors

PMX34 Series (Bipolar - 1.8° Step) Performance Curves

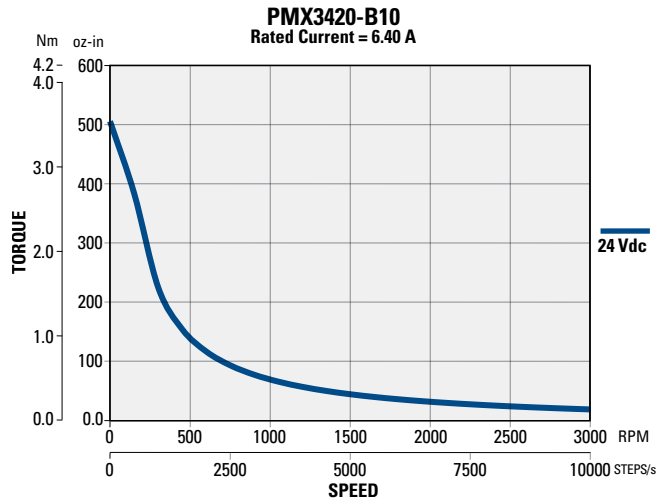
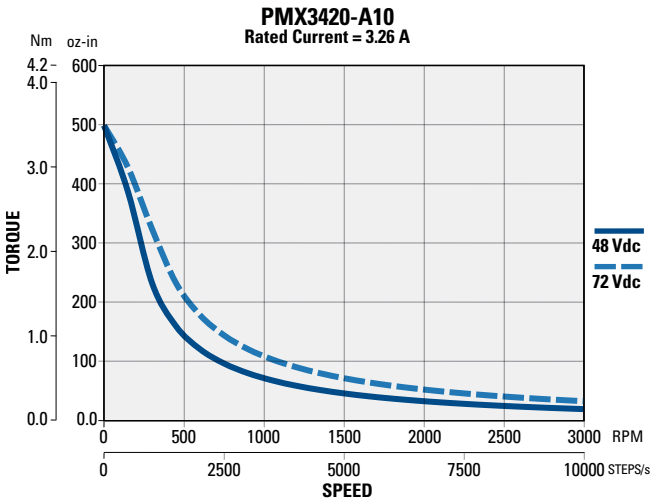
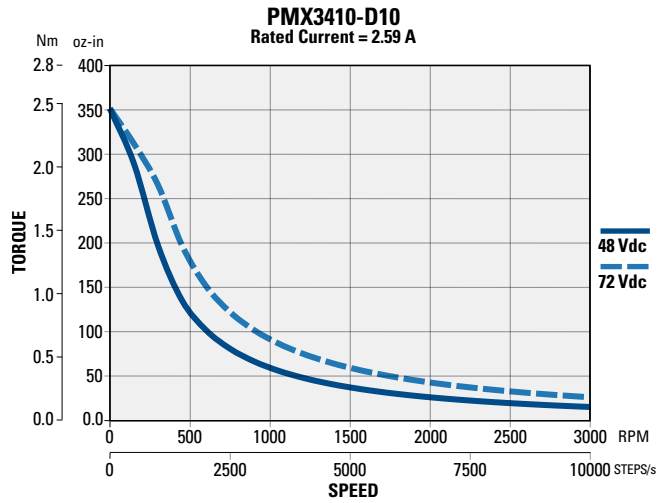
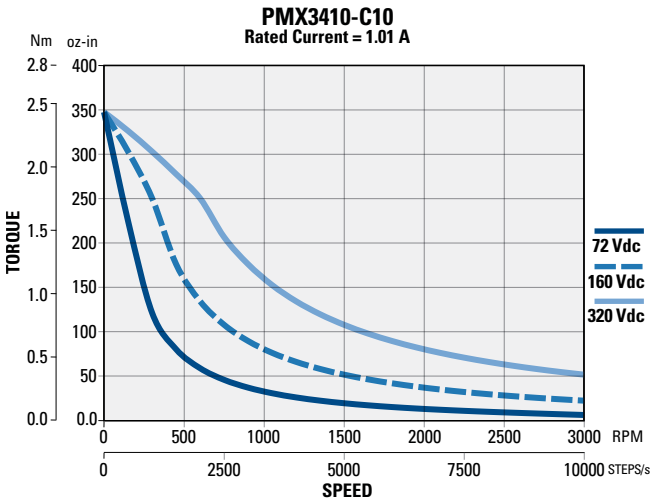
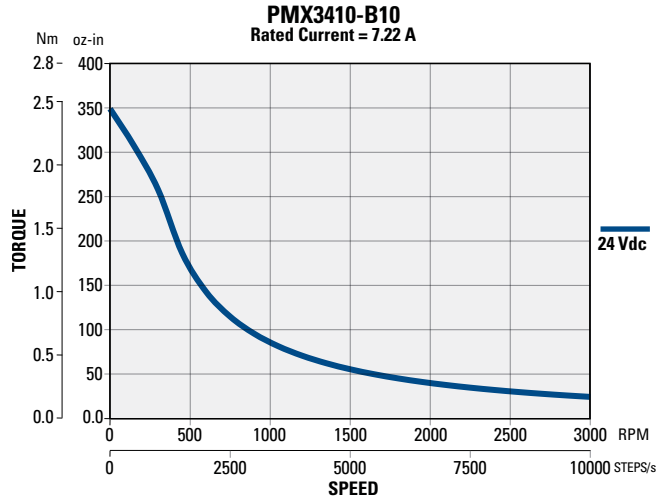
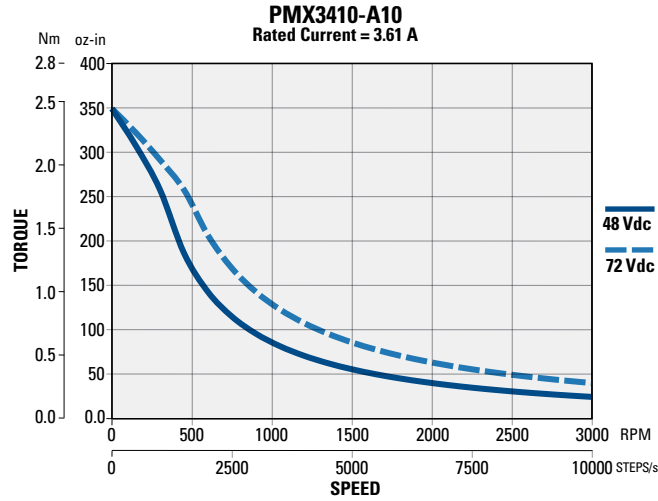

PMX34 Series (Bipolar - 1.8° Step) Performance Curves

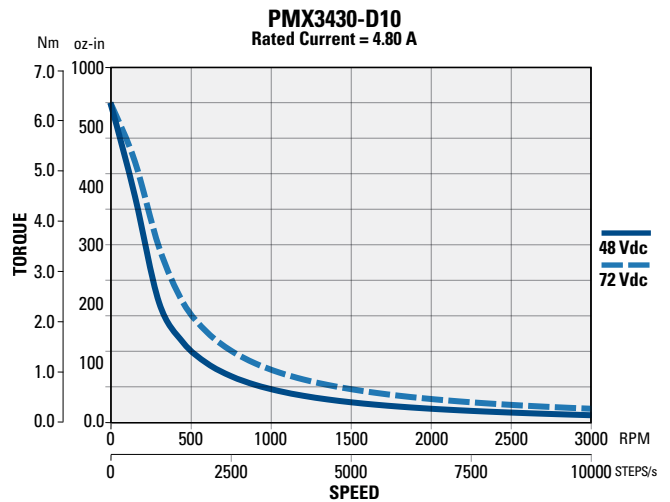
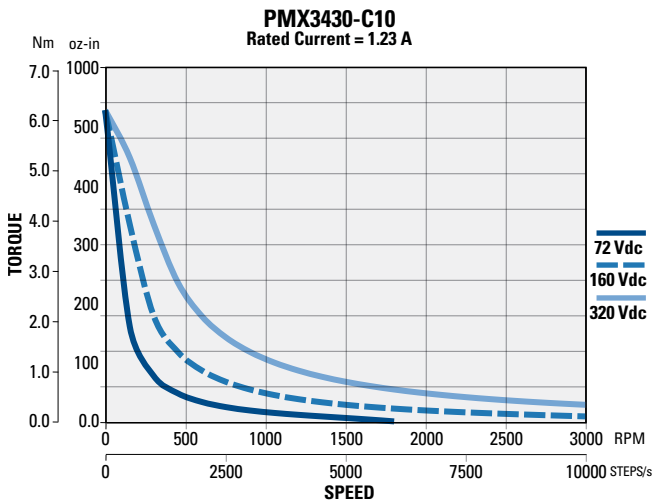
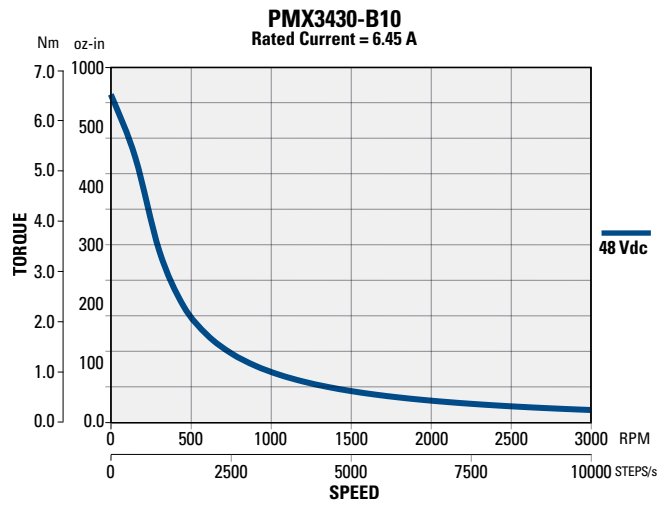
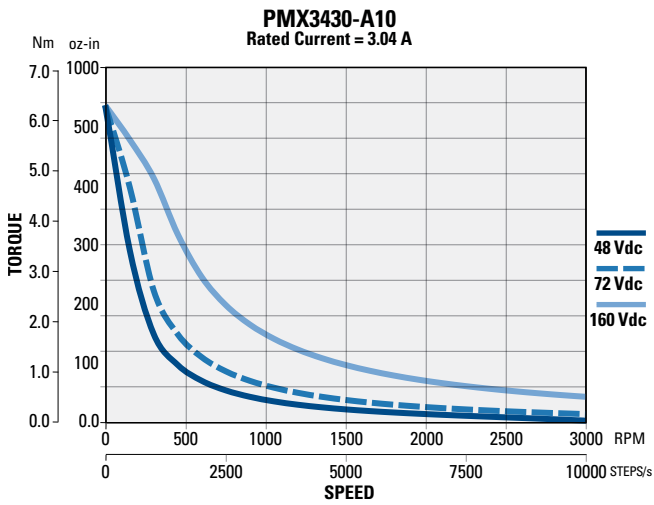
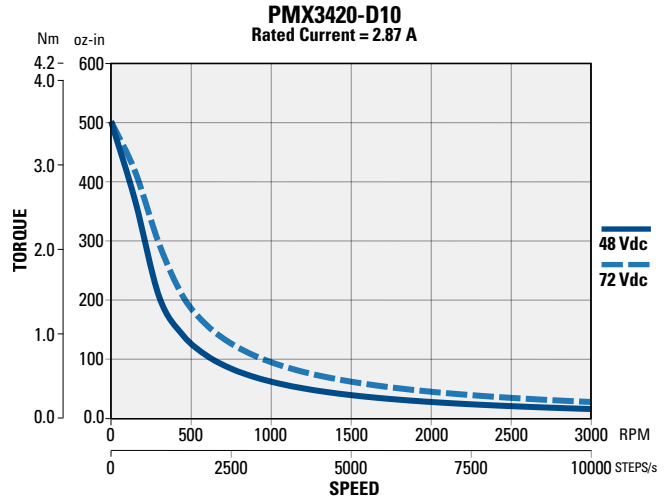
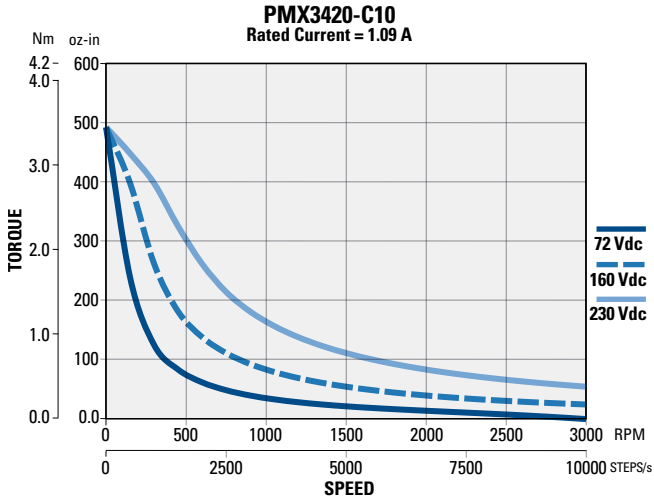

PMX34 Series Stepper Motors

PMX34 Series (Bipolar - 1.8° Step) Performance Curves

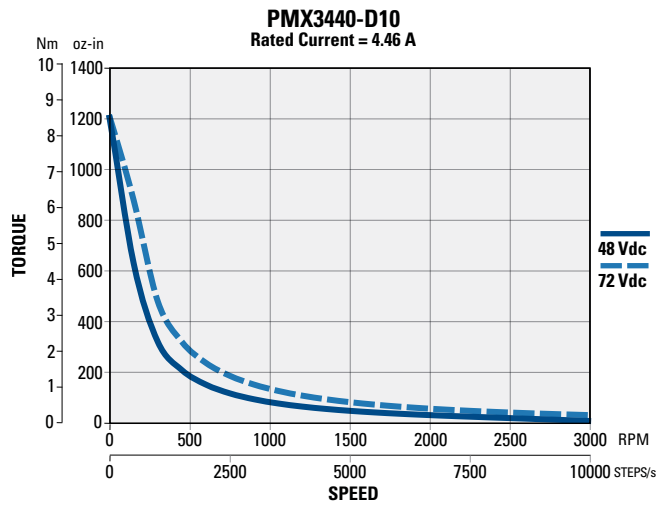
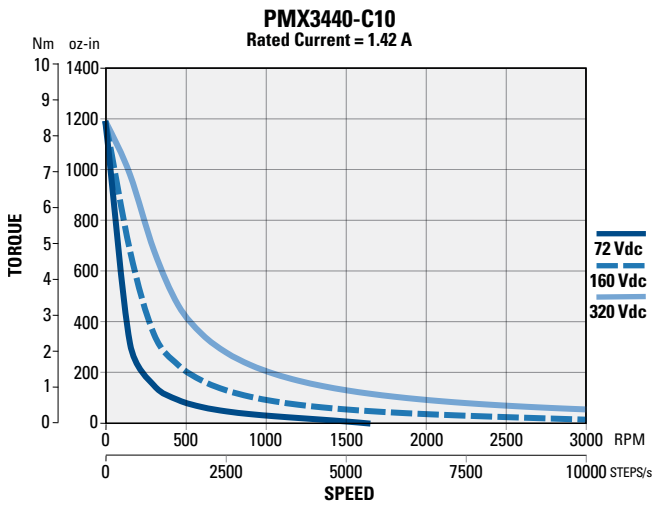
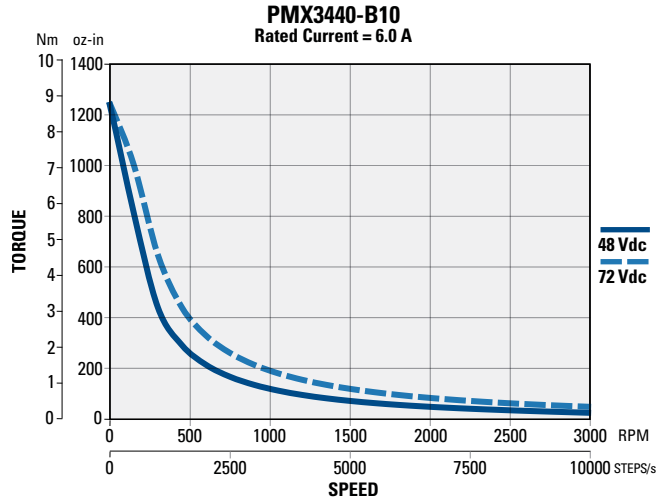
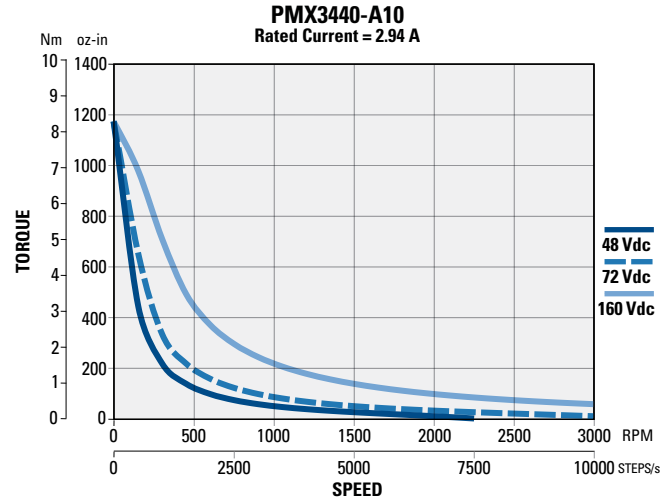

Notes

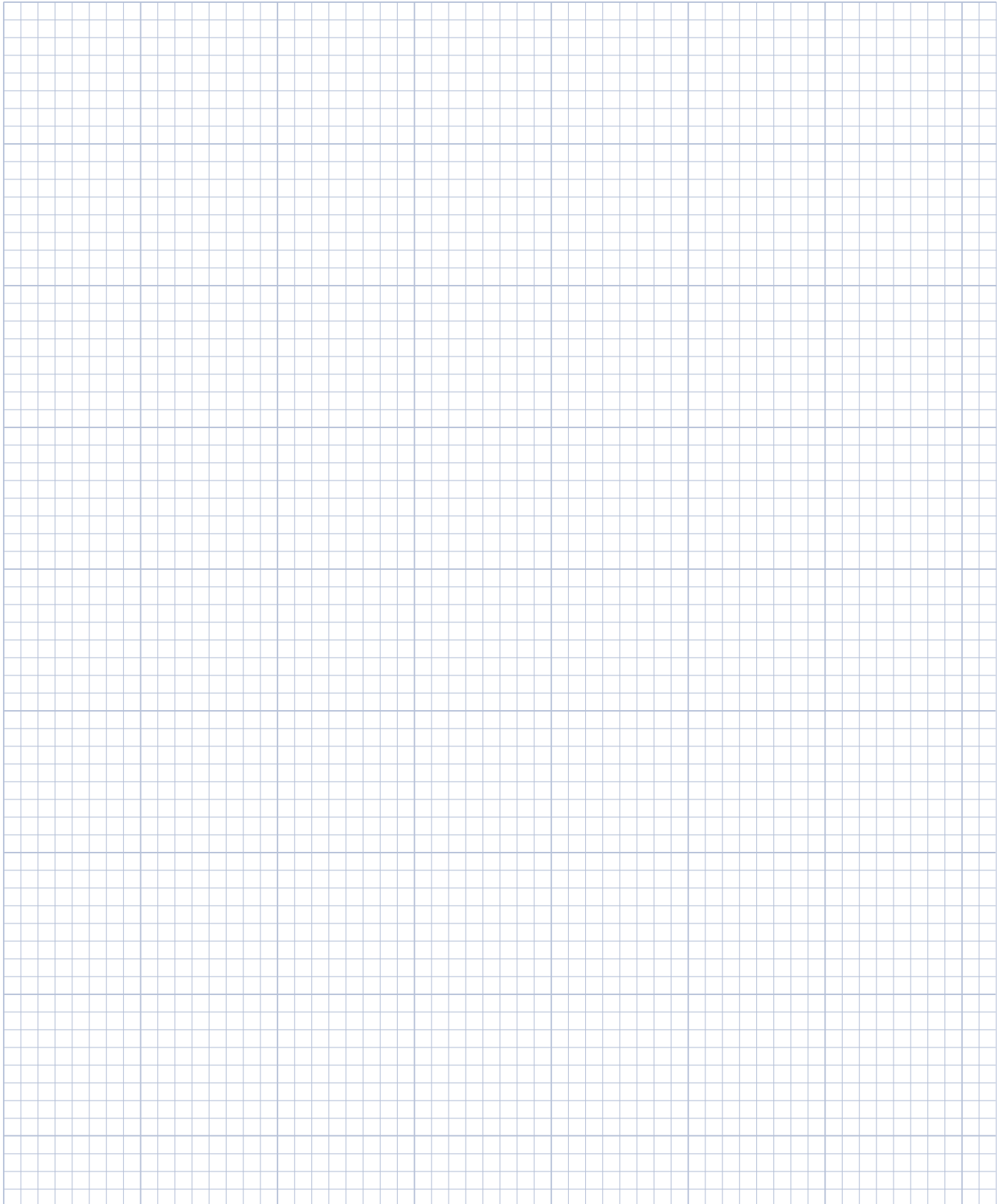

0.125 inch divisions

CT Series Stepper Motors

CT Series Stepper Motors run cooler, produce more torque, and support higher shaft loads than any other stepper motor.

CTM Series motors incorporate enhanced magnets in the stator to provide 25% more torque at all speeds. The increased power output comes from higher efficiency. This allows the use of smaller drives and power supplies and is available in size 23 motors. All CT motors utilize high torque magnetic designs that feature a large rotor diameter, small air gap, high energy rotor magnets and computer controlled windings. This provides maximum torque in the smallest package.

- » Lower Energy Usage
- » Faster Machines
- » Lower System Cost

High Voltage Insulation

Inset molded insulation system encases the stator, eliminating joints and gaps that can fail. Reliability and voltage ratings are increased. CT Series motors can be used with all standard drives, as well as high voltage high performance drives.

- » Faster design cycles knowing CT Series motors work with all drives.
- » Higher reliability

Cooling Shell

Aluminum shell and aluminum end-caps quickly remove heat from the motor. This allows for higher current and torque ratings, especially when the motor is mounted. CT motors produce the same torque at lower temperatures for longer life.

- » Faster, higher throughput machines
- » Reduced size
- » Longer Life

Large Bearing System

To accommodate high thrust loads and high side loading, CT Series motors feature large bearings. Size 23 motors have the front bearing retained with a snap ring. And, the rear bearing is mounted in an O-ring to prevent spinout and minimize motor noise.

- » Lower machine costs. Loads can be directly mounted on motor shaft eliminating couplings and load support bearings.
- » Excellent for leadscrew applications
- » Longer life

CT Series

CT Series motors include the most popular sizes, options and value suitable for most commercial and industrial applications. Enhanced motors provide the maximum performance available. This technology boosts torque an additional 25% to 40% across the entire speed range, and allows machines to be designed that are smaller and move faster.

CT Series Benefits

- » Smaller drives result in a lower system cost
- » More torque allows for smaller, faster machines
- » Higher efficiency enables lower operating costs



Size 17 CT Series

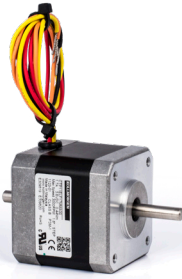

2 Phase, 1.8° Step Motors. Frame size: 1.7 inch, 43 mm
(CTP High Torque Performance Series)

Series	Construction		Holding Torque (Motor Mounted)		Length	
	Style	Stacks	Bipolar		in	mm
			oz-in	Nm		
CTP10	Un-Enhanced	Short	43	0.30	1.37	34.7
CTP11		1	62	0.44	1.61	40.9
CTP12		2	80	0.56	1.92	48.8

- » Inch or metric mounting
- » Rear shaft option

Size 23 CT Series

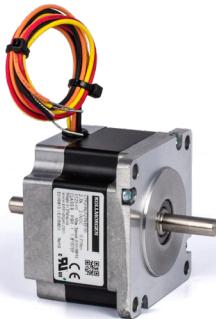

2 Phase, 1.8° Step Motors. Frame size: 2.2 inch, 57 mm
(CTM Enhanced-Max Torque and Efficiency, CTP High Torque Performance Series)

Series	Construction		Holding Torque (Motor Mounted)		Length	
	Style	Stacks	Bipolar		in	mm
			oz-in	Nm		
CTM21	Enhanced	1	260	1.84	2.13	54.1
CTM22		2	470	3.32	3.32	84.3
CTP20	Un-Enhanced	Short	100	0.71	1.62	41.2
CTP21		1	200	1.41	2.13	54.1
CTP22		2	360	2.54	3.32	84.3

- » Captured heavy duty bearings
- » High voltage insulation system
- » Rear shaft option



CT Series Stepper Motors

CT Series Stepper Motor Connection Information

"S" 6-Lead Configuration

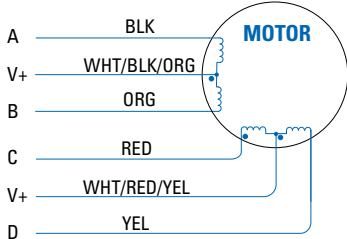

6-Lead Unipolar Connection

Driver Connection	Lead Color
A	Black (Blk)
B	Orange (Org)
C	Red
D	Yellow (Yel)
V+	Wht/Blk/Org
V+	Wht/Red/Yel

Unipolar Full Step Phase Sequence

STEP	A	B	C	D
1	GND	0	GND	0
2	0	GND	GND	0
3	0	GND	0	GND
4	GND	0	0	GND
1	GND	0	GND	0

CCW ↓ ↑ CW

"F" 4-Lead Configuration

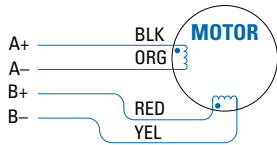

4-Lead Bipolar Connection

Driver Connection	Lead Color
A	Black
\bar{A}	Orange
B	Red
\bar{B}	Yellow

Bipolar Full Step Phase Sequence

STEP	A	\bar{A}	B	\bar{B}
1	+	-	-	+
2	-	+	-	+
3	-	+	+	-
4	+	-	+	-
1	+	-	-	+

CCW ↓ ↑ CW

CT Series Stepper Motor Nomenclature

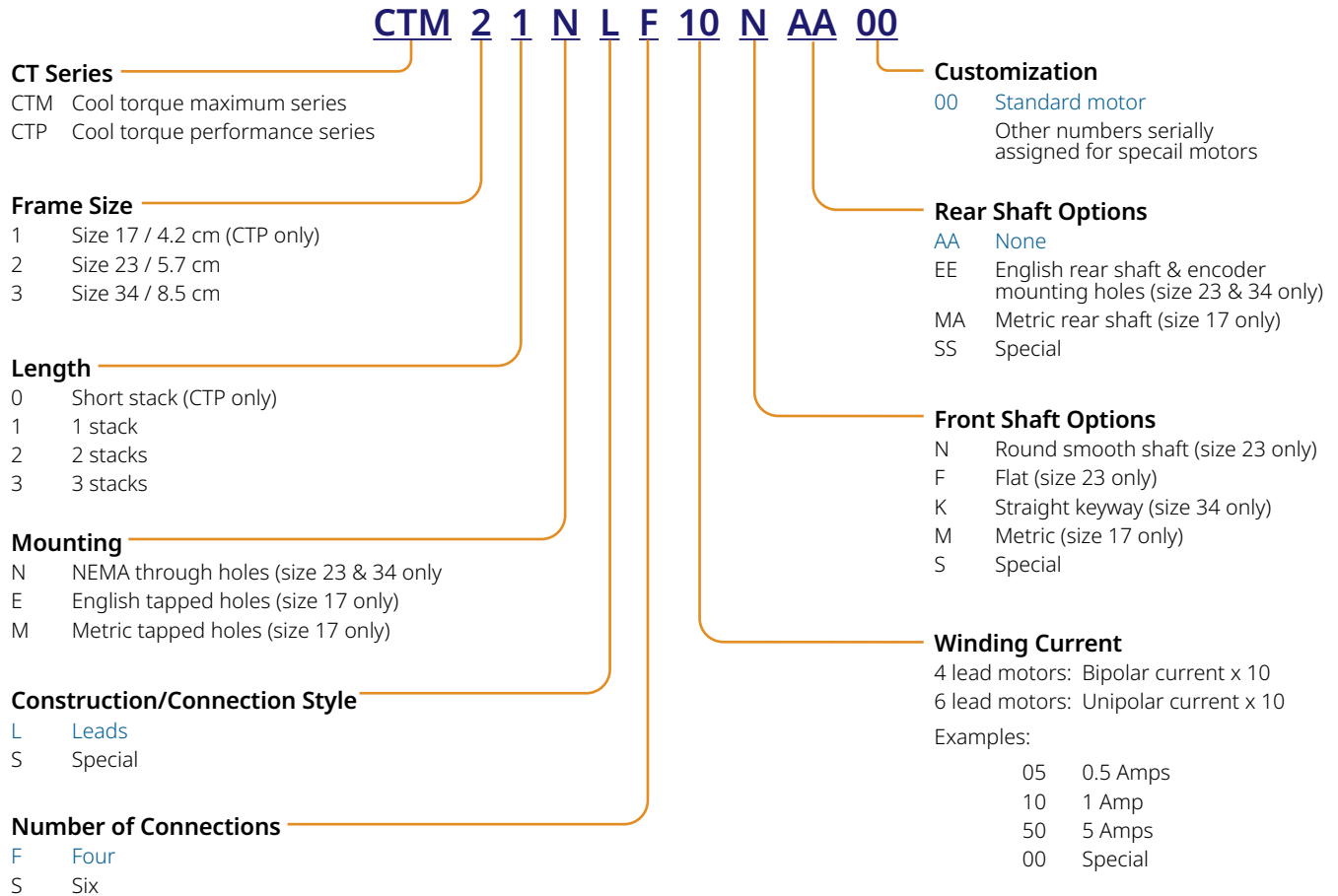

CTP1 Series Stepper Motors

CTP1 General Specifications

- » NEMA Size 17
- » Excellent for use with leadscrews
- » UL, CE, and RoHS compliant
- » Unipolar or Bipolar windings
- » Standard Features: Shaft Flats, Rear Shaft, Encoder Mounting Provisions
- » Co-Engineered Options: Shaft Modifications, Special Windings, Lead Lengths, Connectors

Parameter	CTP1
NEMA frame size	17
Windings	Unipolar and Bipolar
Full Steps per Revolution	200
Step Angle (degrees)	1.8
Step Accuracy % (of one full step, no load)	+/- 5
Operating Temperature	-20° C to +40° C
Insulation Class	Class B, 130° C
Insulation Voltage (Vdc)	80
Insulation Resistance	100 Megohms

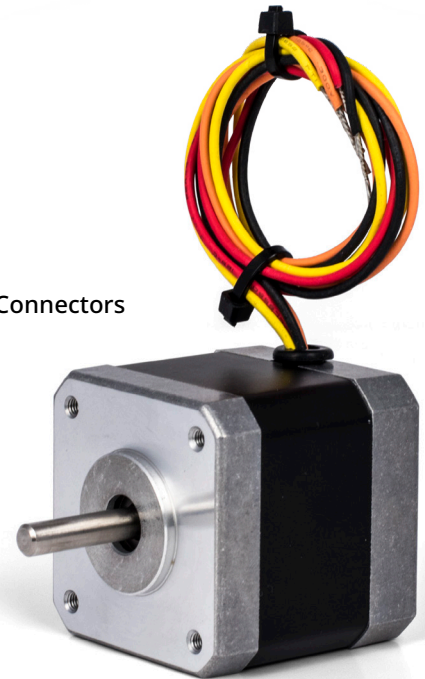

CTP1 Outline Drawings

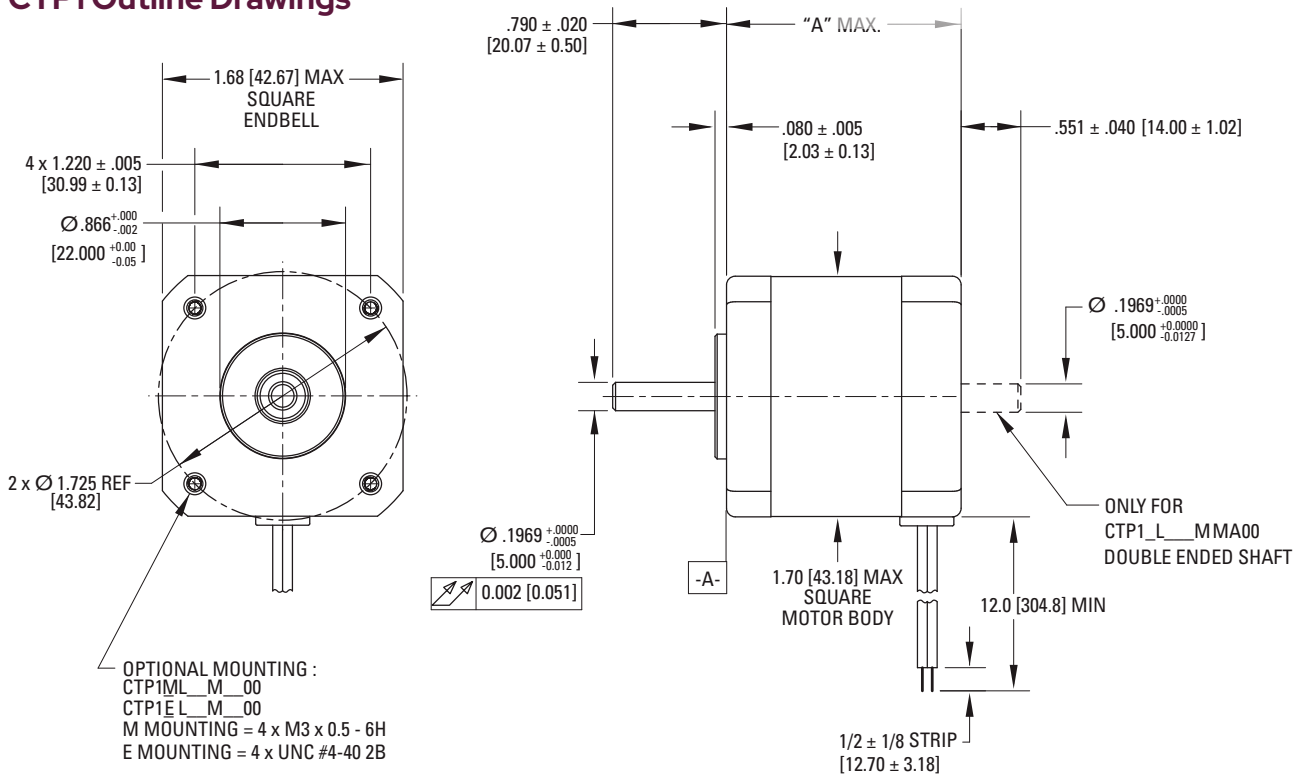

Model	"A" MAX
CTP10	1.350 ± 0.015 (34.3 ± 0.38)
CTP11	1.590 ± 0.015 (40.4 ± 0.38)
CTP12	1.900 ± 0.015 (48.3 ± 0.38)

Dimensions in inches [mm]

CTP1 Performance Data

Motor Model Number	Config.		Holding Torque (2 phases on)	Rated Current/Phase	Phase Resistance	Phase Inductance	Thermal Resistance	Rotor Inertia	Weight	Shaft Loading*	
	Series	Unipolar								oz-in (Nm) +/-10%	Amps DC
			lb (N)	lb (N)							
Short Stack	CTP10xxF16	•	43 (0.30)	1.6	2.15	3.0	6.21	0.00051 (0.0036)	0.45 (0.20)	15 (67)	Push 6.0 (27) Pull 15 (67)
	CTP10xxF10	•		1.0	5.25	7.7					
	CTP10xxF06	•		0.63	12.8	18					
	CTP10xxF04	•		0.40	30.5	42					
	CTP10xxS12	•	33 (0.23)	1.2	3.38	2.4					
	CTP10xxS08	•		0.80	8.04	5.5					
	CTP10xxS05	•		0.50	19.4	13					
	CTP10xxS03	•		0.33	47.1	31					
1 Stack	CTP11xxF17	•	62 (0.44)	1.7	2.12	4.2	5.44	0.00075 (0.0053)	0.57 (0.26)	15 (67)	Push 6.0 (27) Pull 15 (67)
	CTP11xxF11	•		1.1	5.19	11					
	CTP11xxF07	•		0.68	12.5	26					
	CTP11xxF04	•		0.44	30.4	60					
	CTP11xxS13	•	49 (0.35)	1.3	3.31	3.4					
	CTP11xxS09	•		0.85	8.02	8.0					
	CTP11xxS06	•		0.55	18.9	18					
	CTP11xxS03	•		0.35	48.1	47					
2 Stack	CTP12xxF26	•	80 (0.56)	2.6	1.09	1.9	4.71	0.00106 (0.075)	0.76 (0.34)	15 (67)	Push 6.0 (27) Pull 15 (67)
	CTP12xxF16	•		1.6	2.65	4.9					
	CTP12xxF10	•		1.0	6.51	12					
	CTP12xxF07	•		0.65	15.7	30					
	CTP12xxS20	•	62 (0.44)	2.0	1.70	1.6					
	CTP12xxS13	•		1.3	4.13	3.9					
	CTP12xxS08	•		0.82	10.1	9.2					
	CTP12xxS05	•		0.53	23.8	21					

*Notes: *Maximum shaft loading based on 20,000 hours of operation at 1500 rpm.

CTP1 Series Stepper Motors

CTP1 Performance Curves

CTP10xxF10 w/ P70530

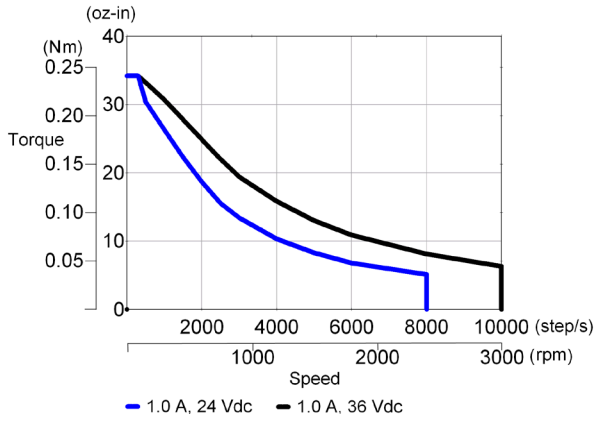

CTP10xxF16 w/ P70530

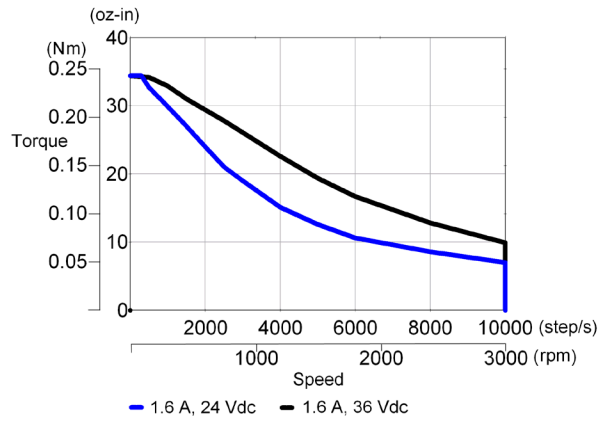

CTP11xxF11 w/ P70530

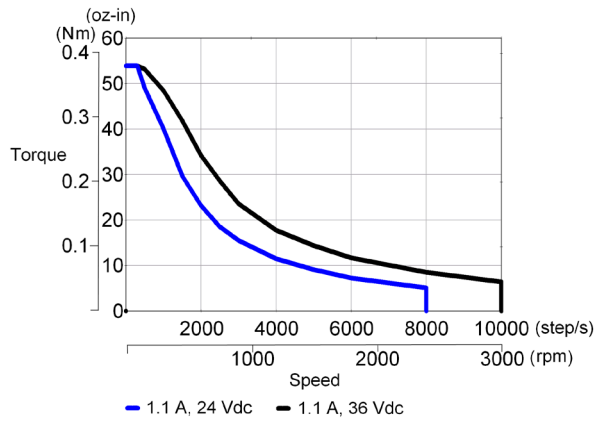

CTP11xxF17 w/ P70530

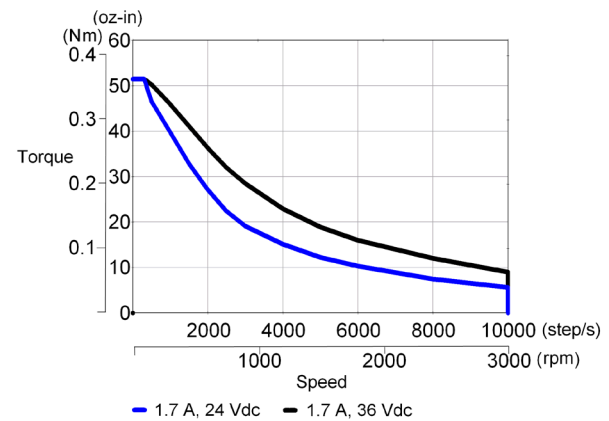

CTP12xxF10 w/ P70530

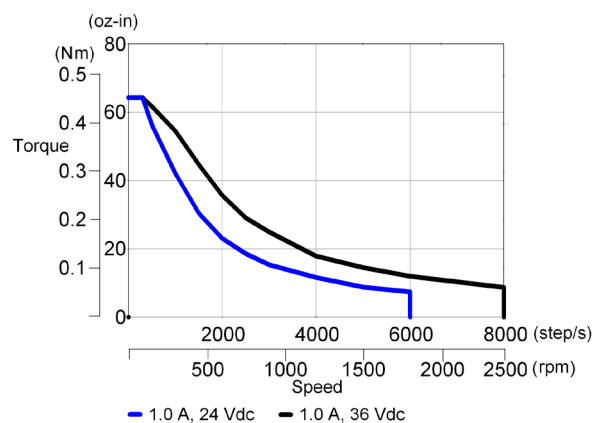

CTP12xxF26 w/ P70530

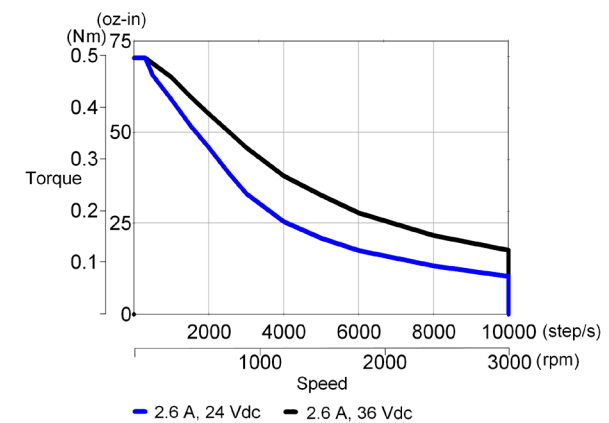

Notes

CTP Motor Series
1 Frame Size
2 Stack Length
M Mounting
L Connection
F # of Connections
10 Winding Current
M Front Shaft Opt.
AA Rear Shaft Opt.
00 Customization

0.125 inch divisions

CT(P/M)2 Series Stepper Motors

CTP2 / CTM2 General Specifications

- » NEMA Size 23
- » CTM Enhanced Series - Maximum Torque and Efficiency
- » Excellent for use with leadscrews
- » UL, CE, and RoHS compliant
- » Unipolar or Bipolar windings
- » Standard Features: Shaft Flats, Rear Shaft, Encoder Mounting Provisions
- » Co-Engineered Options: Shaft Modifications, Special Windings, Lead Lengths, Connectors

Parameter	CTP2 / CTM2
NEMA frame size	23
Windings	Unipolar and Bipolar
Full Steps per Revolution	200
Step Angle (degrees)	1.8
Step Accuracy % (of one full step, no load)	+/- 3
Operating Temperature	-20° C to +40° C
Insulation Class	Class B, 130° C
Insulation Voltage (Vdc)	340
Insulation Resistance	100 Megohms

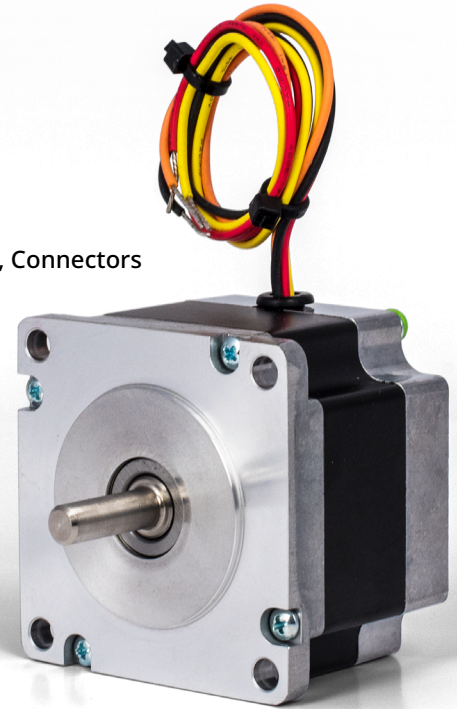

CTP2 / CTM2 Outline Drawings

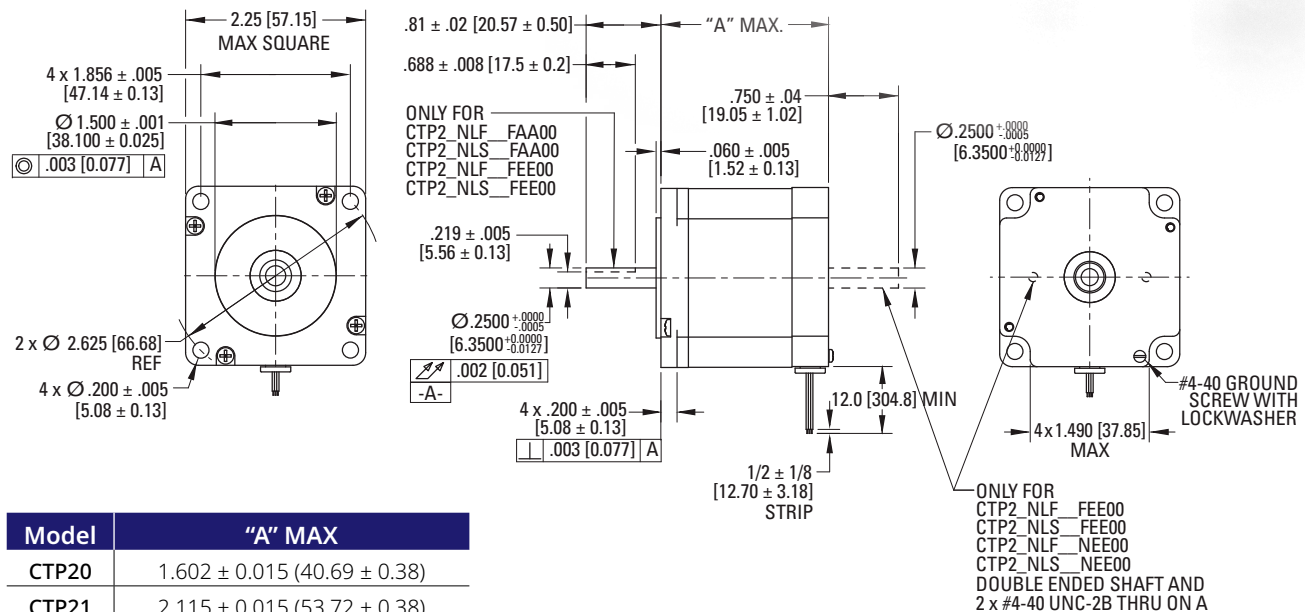

Model	"A" MAX
CTP20	1.602 ± 0.015 (40.69 ± 0.38)
CTP21	2.115 ± 0.015 (53.72 ± 0.38)
CTP22	3.297 ± 0.015 (83.74 ± 0.38)

Dimensions in inches [mm]

CTP2 / CTM2 Performance Data

Motor Model Number	Config.		Holding Torque (2 phases on) oz-in (Nm) +/-10%	Rated Current/Phase Amps DC	Phase Resistance Ohms +/-10%	Phase Inductance mH Typical	Thermal Resistance Mounted °C/Watt	Rotor Inertia oz-in-s ² (kg-m ² x10 ⁻³)	Weight lb (kg)	Shaft Loading*	
	Series	Unipolar								Radial Force lb (N)	Axial Force lb (N)
Short Stack	CTP20xxF38	•	100 (0.71)	3.8	0.58	1.3	3.99	0.0026 (0.018)	1.0 (0.45)	20 (89)	50 (222)
	CTP20xxF27	•		2.7	1.11	2.5					
	CTP20xxF17	•		1.7	2.87	7.1					
	CTP20xxF11	•		1.1	6.98	17					
	CTP20xxF07	•		0.68	17.1	41					
	CTP20xxF04	•		0.45	40.6	89					
	CTP20xxS34	•	75 (0.53)	3.4	0.73	0.83					
	CTP20xxS21	•		2.1	1.83	2.2					
	CTP20xxS13	•		1.3	4.39	5.2					
CTP20xxS09	•		0.87	10.5	12						
1 Stack	CTP21xxF56	•	200 (1.41)	5.6	0.31	1.1	3.57	0.0035 (0.025)	1.4 (0.64)	20 (89)	50 (222)
	CTP21xxF39	•		3.9	0.60	2.2					
	CTP21xxF25	•		2.5	1.48	5.8					
	CTP21xxF15	•		1.5	3.86	16					
	CTP21xxF10	•		1.0	9.40	38					
	CTP21xxF04	•		0.45	44.0	170					
	CTP21xxS48	•	160 (1.13)	4.8	0.41	0.74					
	CTP21xxS31	•		3.1	0.97	1.9					
	CTP21xxS19	•		1.9	2.44	5.0					
CTP21xxS12	•		1.2	5.89	12						
Enhanced 1 Stack	CTM21xxF56	•	260 (1.84)	5.6	0.31	0.78	3.57	0.0035 (0.025)	1.5 (0.68)	20 (89)	50 (222)
	CTM21xxF39	•		3.9	0.60	1.6					
	CTM21xxF25	•		2.5	1.48	4.2					
	CTM21xxF15	•		1.5	3.86	12					
	CTM21xxF10	•		1.0	9.40	28					
	CTM21xxF04	•		0.45	44.0	123					
	CTM21xxS48	•	200 (1.41)	4.8	0.41	0.54					
	CTM21xxS31	•		3.1	0.97	1.4					
	CTM21xxS19	•		1.9	2.44	3.7					
CTM21xxS12	•		1.2	5.89	8.6						

Notes: *Maximum shaft loading based on 20,000 hours of operation at 1500 rpm.

Continued on next page

CT(P/M)2 Series Stepper Motors

CTP2 / CTM2 Performance Data (continued)

Motor Model Number	Config.		Holding Torque (2 phases on) oz-in (Nm) +/-10%	Rated Current/Phase Amps DC	Phase Resistance Ohms +/-10%	Phase Inductance mH Typical	Thermal Resistance Mounted °C/Watt	Rotor Inertia oz-in-s ² (kg-m ² x10 ⁻³)	Weight lb (kg)	Shaft Loading*	
	Series	Unipolar								Radial Force lb (N)	Axial Force lb (N)
2 Stack	CTP22xxF69	•	360 (2.54)	6.9	0.28	1.2	2.62	0.0068 (0.048)	2.4 (1.09)	20 (89)	50 (222)
	CTP22xxF50	•		5.0	0.52	2.2					
	CTP22xxF31	•		3.1	1.31	6.1					
	CTP22xxF19	•		1.9	3.25	16					
	CTP22xxF12	•		1.2	8.40	41					
	CTP22xxF06	•		0.60	32.2	150					
	CTP22xxS49	•	285 (2.01)	4.9	0.53	1.2					
	CTP22xxS31	•		3.1	1.30	3.0					
	CTP22xxS19	•		1.9	3.39	8.3					
CTP22xxS12	•	1.2	8.26	20							
Enhanced 2 Stack	CTM22xxF69	•	470 (3.32)	6.9	0.28	0.81	2.62	0.0068 (0.048)	2.5 (1.13)	20 (89)	50 (222)
	CTM22xxF50	•		5.0	0.52	1.6					
	CTM22xxF31	•		3.1	1.31	4.3					
	CTM22xxF19	•		1.9	3.25	11					
	CTM22xxF12	•		1.2	8.40	29					
	CTM22xxF06	•		0.60	32.2	108					
	CTM22xxS49	•	360 (2.54)	4.9	0.53	0.81					
	CTM22xxS31	•		3.1	1.30	2.1					
	CTM22xxS19	•		1.9	3.39	5.9					
	CTM22xxS12	•		1.2	8.26	14					

Notes: *Maximum shaft loading based on 20,000 hours of operation at 1500 rpm.

CTP2 / CTM2 Performance Curves

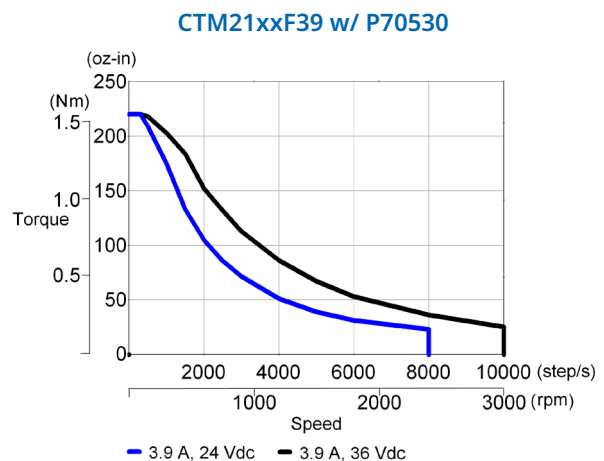
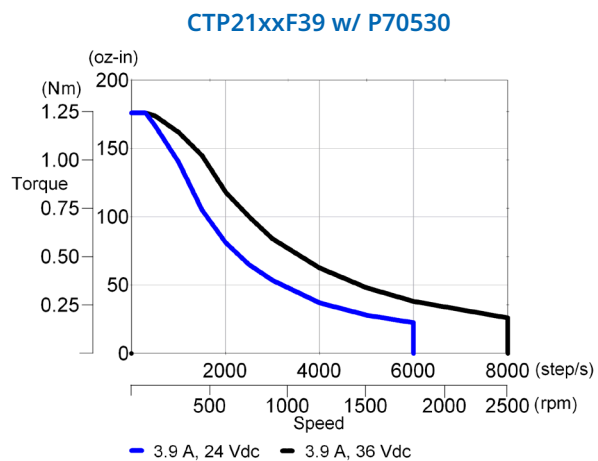
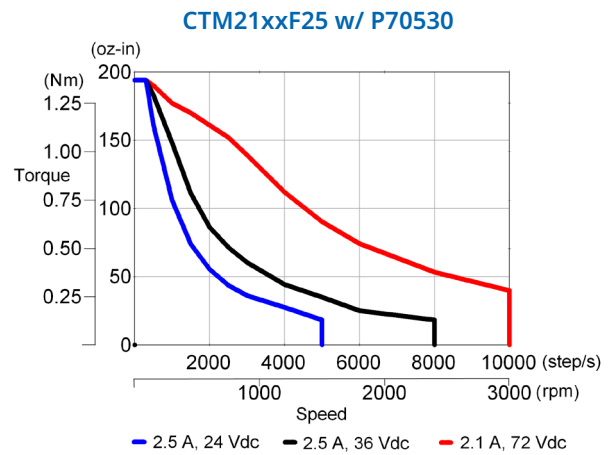
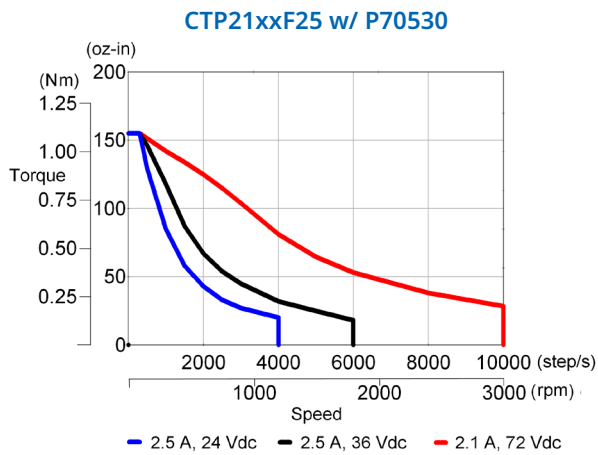
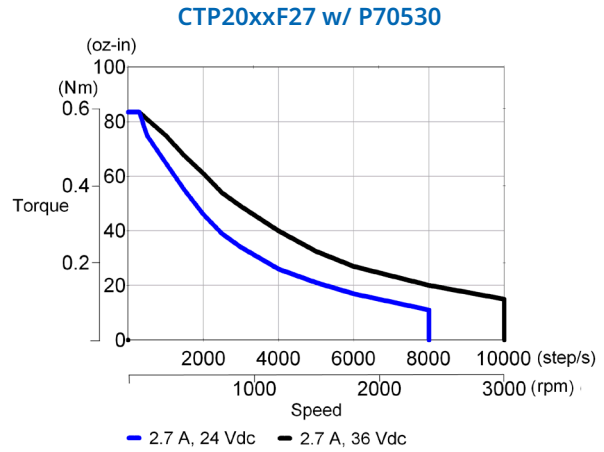
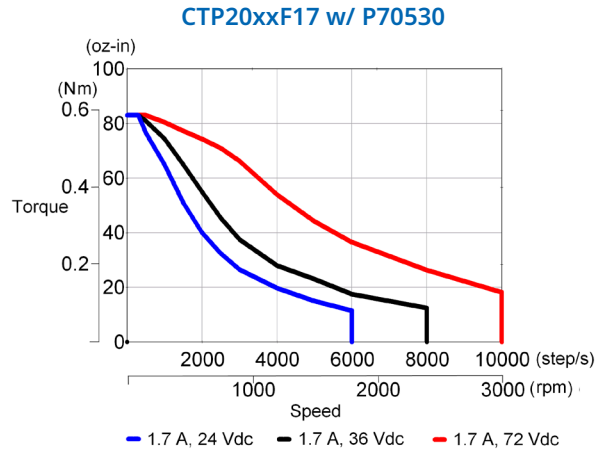

CT(P/M)2 Series Stepper Motors

CTP2 / CTM2 Performance Curves (continued)

CTP21xxF15 w/ P70530

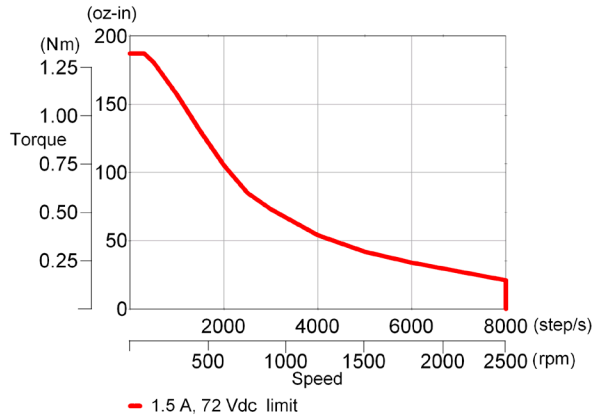

CTM21xxF15 w/ P70530

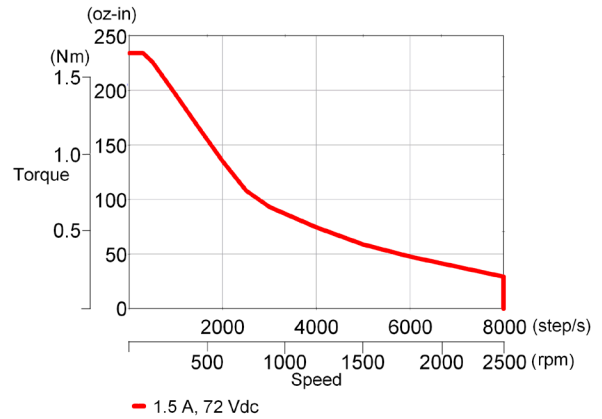

CTP22xxF50 w/ P70530

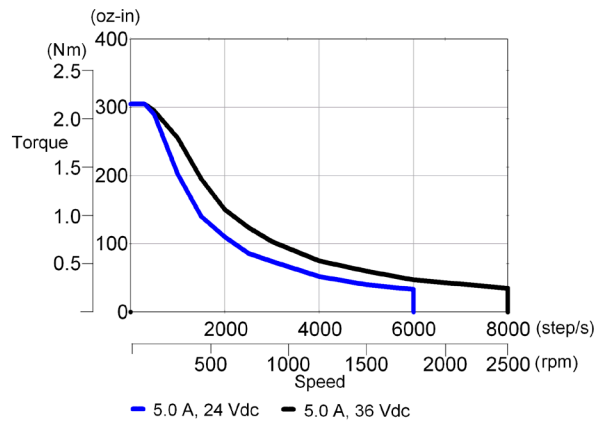

CTM22xxF50 w/ P70530

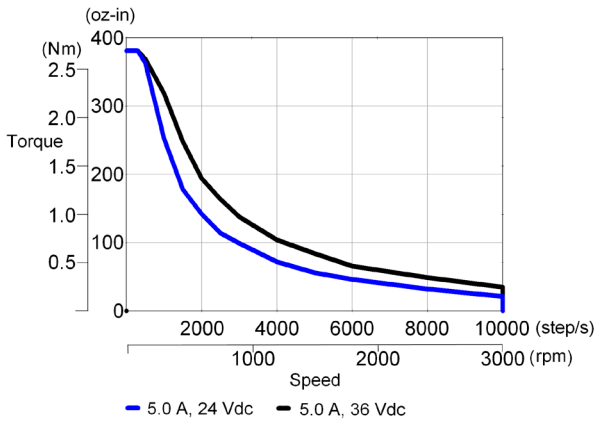

CTP22xxF31 w/ P70530

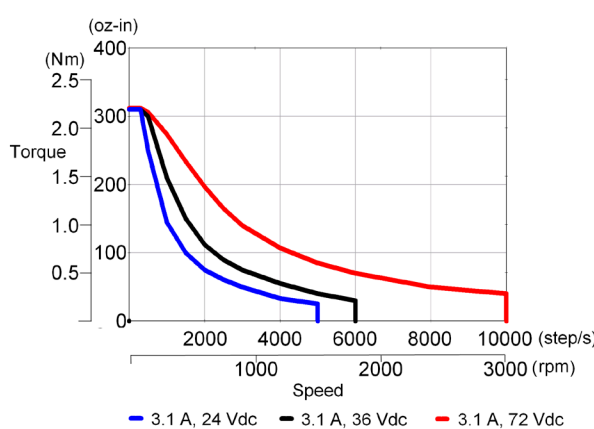

CTM22xxF31 w/ P70530

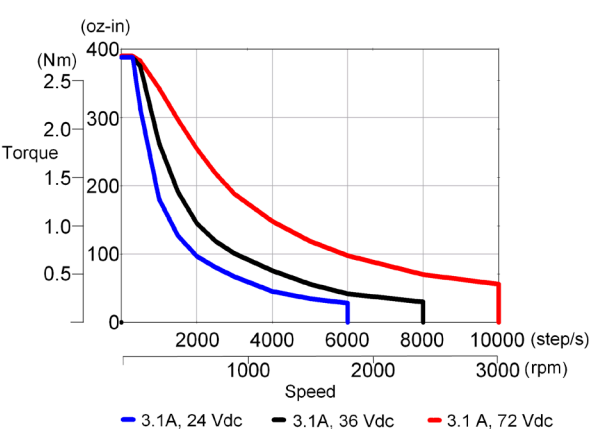

CTP2 / CTM2 Performance Curves (continued)

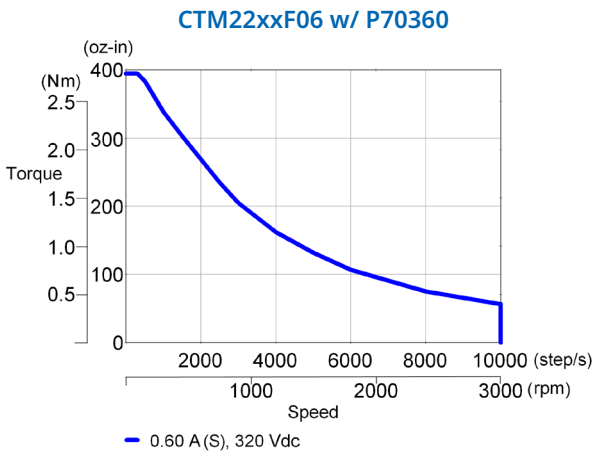
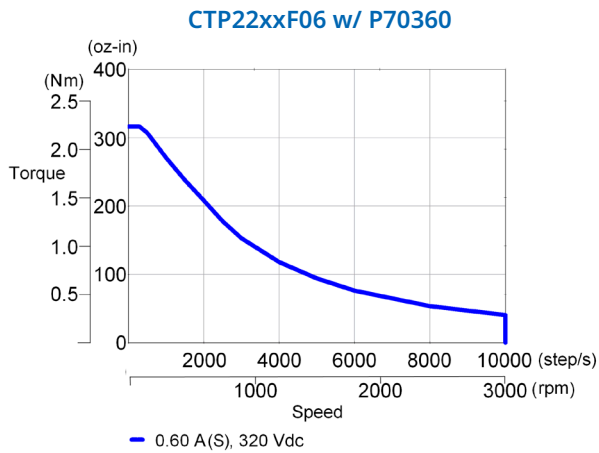
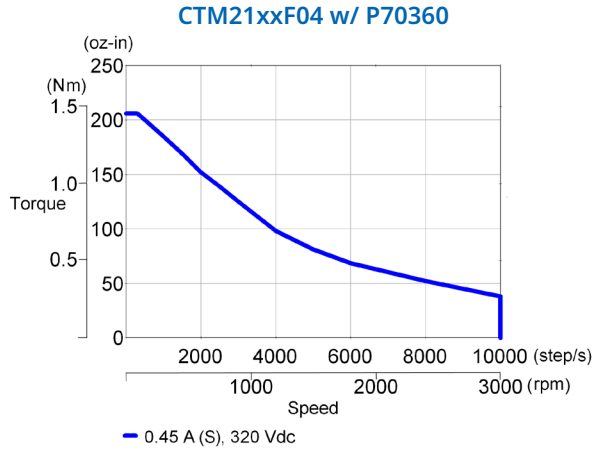
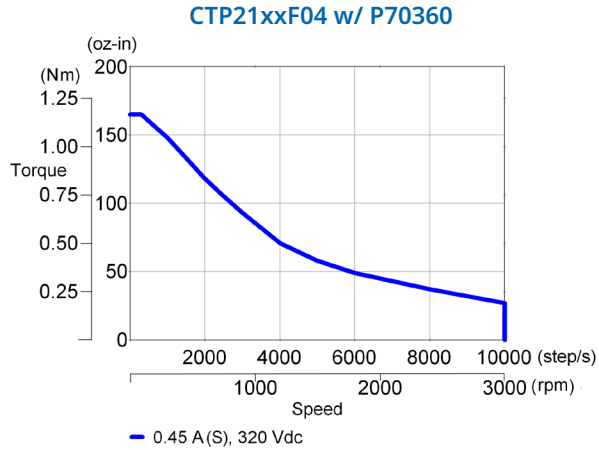

T2 Series Stepper Motors

Kollmorgen T2 Series stepper motors provide high torque in a NEMA 23 frame size (60 mm).

With holding torques to 421 oz-in (3.0 N-m), these steppers deliver the most torque of any Size 23 motor. They are available with open leads or a terminal box, and offer an excellent alternative to pneumatic, hydraulic and servo motor systems.

Features

- » 0.56 to 3.0 N-m (80 to 421 oz-in) holding torque accommodates most high torque application requirements
- » 0.014 to 0.049 N-m (2 to 7 oz-in) detent torque leaves more power for moving the load
- » Speeds up to 3000 RPM meet the velocity demands of most high torque application

General Specifications

- » NEMA Size 23
- » High Torque at moderate speeds
- » Inch standard mounting
- » UL, CE compliant
- » Unipolar or Bipolar windings
- » Standard Features: Shaft Flats, Rear Shaft, Flying Leads or Motor-Mounted Connectors, Encoder Mounting Provisions, Incremental Encoders
- » Co-Engineered Options: Shaft Modifications, Special Windings, Lead Lengths, Connectors

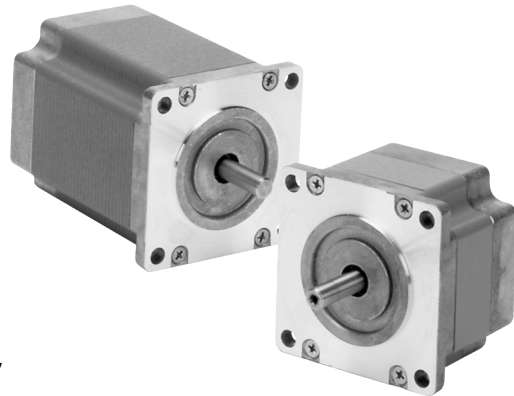

Parameter	T2
NEMA frame size	23
Windings	Unipolar and Bipolar
Full Steps per Revolution	200
Step Angle (degrees)	1.8
Step Accuracy % (of one full step, no load)	+/- 2
Operating Temperature	-20° C to +40° C
Insulation Class	Class B, 130° C
Insulation Voltage (Vdc)	340
Insulation Resistance	100 Megohms

T2 Series Stepper Motors

T2 Series Stepper Motor Connection Information

6-Lead Configuration

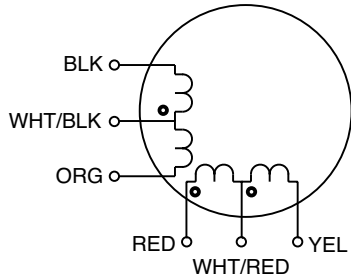

6-Lead Unipolar Connection

Driver Connection	Lead Color
A	Black (Blk)
B	Orange (Org)
C	Red
D	Yellow (Yel)
V+	Wht/Blk/Org
V+	Wht/Red/Yel

Unipolar Full Step Phase Sequence

STEP	A	B	C	D
1	GND	0	GND	0
2	0	GND	GND	0
3	0	GND	0	GND
4	GND	0	0	GND
1	GND	0	GND	0

CCW ↓ ↑ CW

4-Lead Configuration

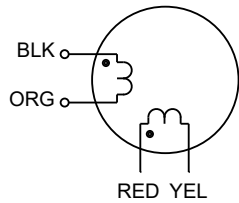

4-Lead Bipolar Connection

Driver Connection	Lead Color	MS Connector
A	Black	A
\bar{A}	Orange	B
B	Red	C
\bar{B}	Yellow	D
Ground	Grn/Yel	E

Bipolar Full Step Phase Sequence

STEP	A	\bar{A}	B	\bar{B}
1	+	-	-	+
2	-	+	-	+
3	-	+	+	-
4	+	-	+	-
1	+	-	-	+

CCW ↓ ↑ CW

Optional MS Connector

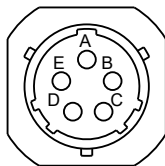

T2 Series Stepper Motor Nomenclature

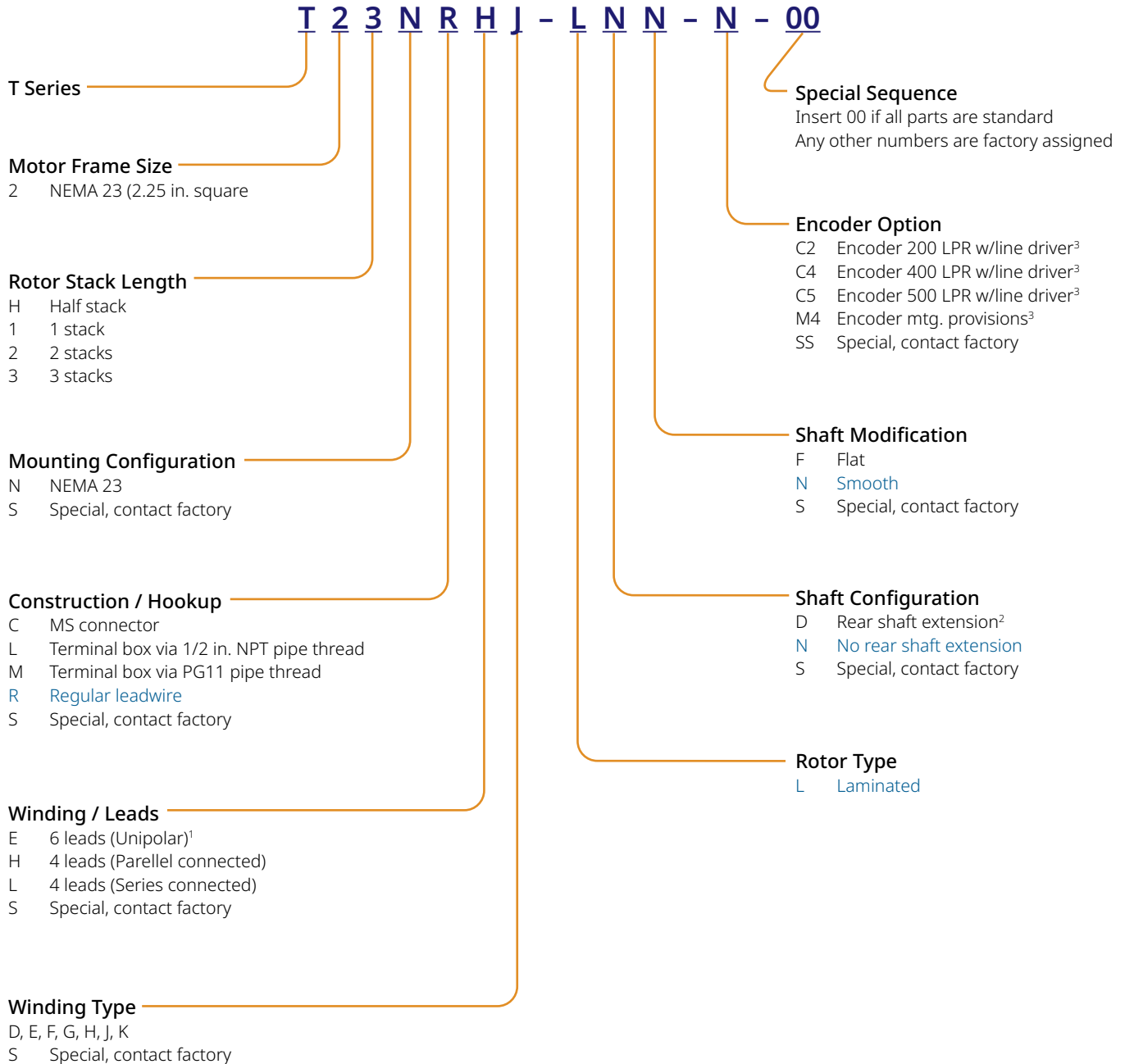

Notes:

1. N/A with "C" Construction / Hookup option
2. "R" Construction / Hookup only, required for motors with encoders
3. Requires "R" Construction / Hookup option and "D" Shaft Configuration option

T2 Series Stepper Motors

T2 Outline Drawings

Leadwire Hookup Models

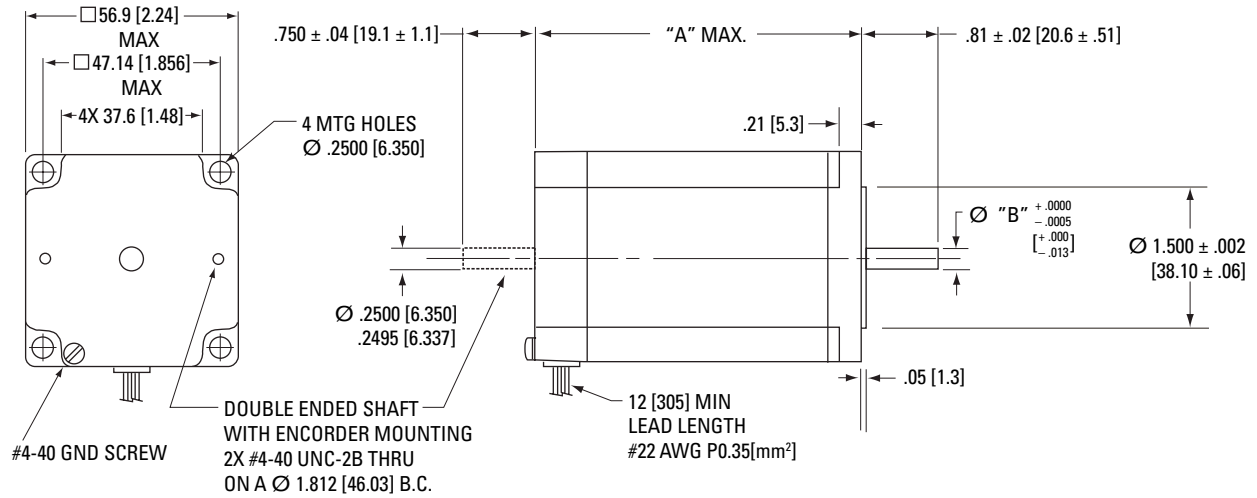

Model	"A" Max	"B" Max
T2H	1.64 (41.6)	0.2500 (6.35)
T21	2.21 (56.1)	
T22	3.06 (77.7)	
T23	4.06 (103.1)	

Dimensions in inches [mm]

Terminal Box Construction

Model	"A" Max
T2H	2.84 (72.1)
T21	3.41 (86.6)
T22	4.26 (108.2)
T23	5.26 (133.6)

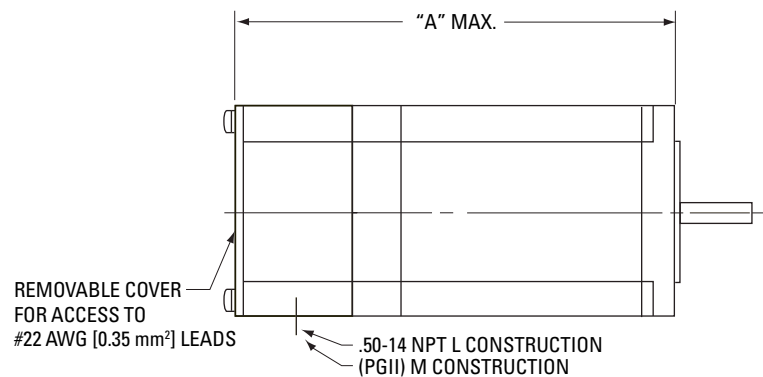

Dimensions in inches [mm]

T2 Performance Data

Motor Model Number	Config.		Holding Torque (2 phases on) oz-in (Nm) +/-10%	Rated Current/Phase Amps DC	Phase Resistance Ohms +/-10%	Phase Inductance mH Typical	Thermal Resistance Mounted °C/Watt	Rotor Inertia oz-in-s ² (kg-m ² x 10 ⁻³)	Weight lb (kg)	Shaft Loading*	
	Parallel	Series								Radial Force lb (N)	Axial Force lb (N)
Short Stack	T2HxxHK	•	74 (0.52)	5.3	0.19	0.63	6.14	0.00154 (0.0109)	1.1 (0.50)	15 (67)	25 (111)
	T2HxxHJ	•		4.0	0.28	1.0					
	T2HxxLH	•		2.7	0.64	2.5					
	T2HxxLD	•		1.1	3.6	16					
1 Stack	T21xxHK	•	180 (1.27)	5.4	0.23	1.1	4.64	0.0034 (0.024)	1.5 (0.68)	15 (67)	25 (111)
	T21xxHJ	•		4.1	0.33	1.8					
	T21xxLC	•		0.4	42.9	209					
	T21xxLH	•		2.7	0.85	4.6					
	T21xxLE	•		1.4	3.0	16					
	T21xxLD	•		1.1	4.9	30					
2 Stack	T22xxHK	•	280 (1.98)	6.6	0.20	0.85	3.69	0.0056 (0.040)	2.2 (1.0)	15 (67)	25 (111)
	T22xxHJ	•		4.1	0.49	2.5					
	T22xxLC	•		0.46	41.4	209					
	T22xxLH	•		3.3	0.75	3.4					
	T22xxLG	•		2.5	1.3	7.1					
	T22xxLE	•		1.5	2.9	17					
3 Stack	T23xxHK	•	380 (2.68)	6.0	0.28	1.5	3.04	0.0084 (0.059)	3.3 (1.5)	15 (67)	25 (111)
	T23xxHJ	•		3.8	0.64	3.9					
	T23xxLC	•		0.67	23.5	136					
	T23xxLH	•		3.0	1.0	6.2					
	T23xxLF	•		1.8	2.8	17					
	T23xxLE	•		1.5	4.1	24					

Note: *Maximum shaft loading based on 20,000 hours of operation at 1500 rpm.

T2 Series Stepper Motors

T2 Performance Curves - DC Drive Models

T21xxLH w/ P70530

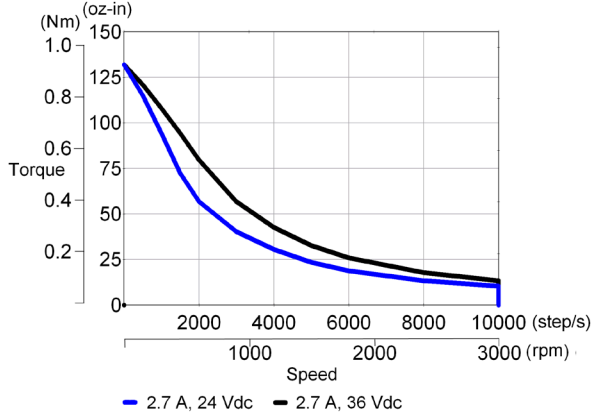

T22xxLG w/ P70530

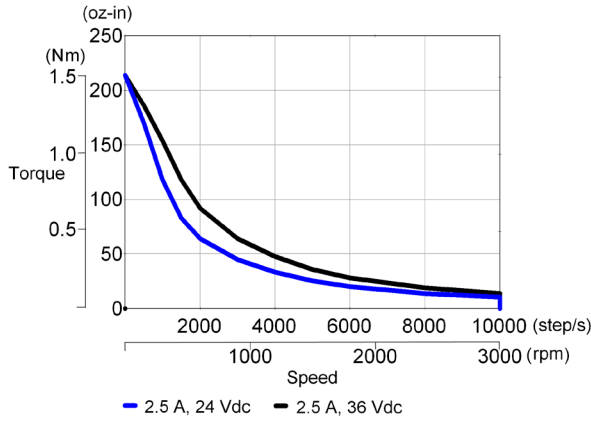

T23xxLH w/ P70530

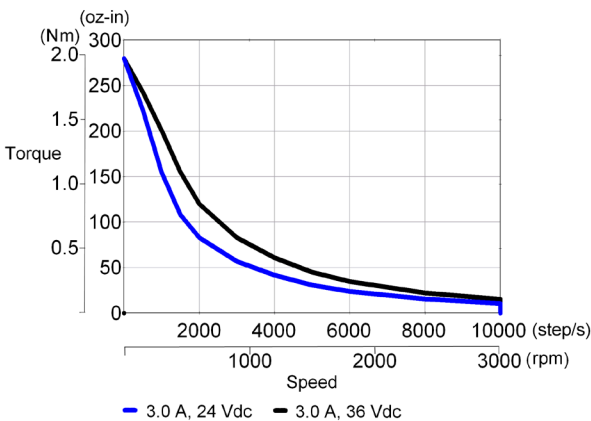

T2 Performance Curves - AC Drive Models

T21xxLC w/ P70360

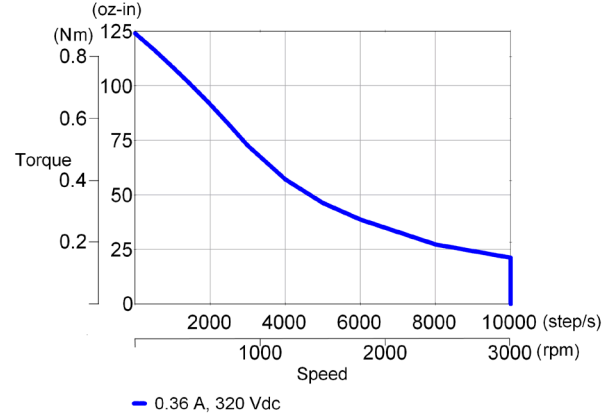

T22xxLC w/ P70360

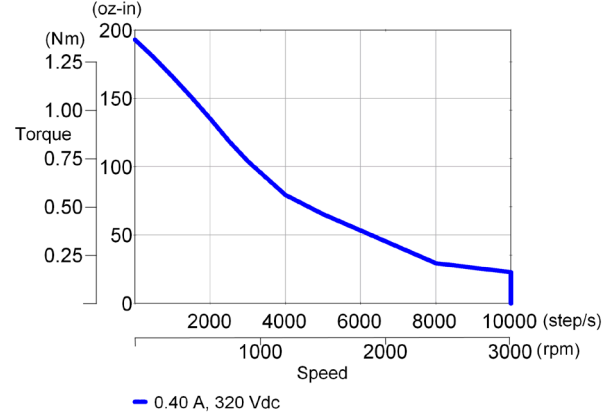

T23xxLC w/ P70360

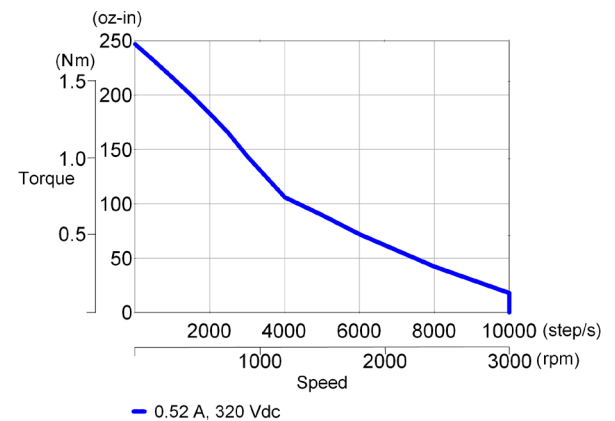

T2 Encoder Option

Encoder Specifications

Parameter	Code		
	C2	C4	C5
Type	Optical Incremental		
Supply Voltage	5 V _{DC} ±10%		
Lines per Revolution	200	400	500
Output Format	Dual Channel Quadrature with Index (Z)		
Output Type	Differential Line Drive (with compliments)		
Output Frequency (kHz)	200		
Operating Temperature (°C)	-20 to 100		
Storage Temperature (°C)	-25 to 85		

Encoder Dimensional Drawings

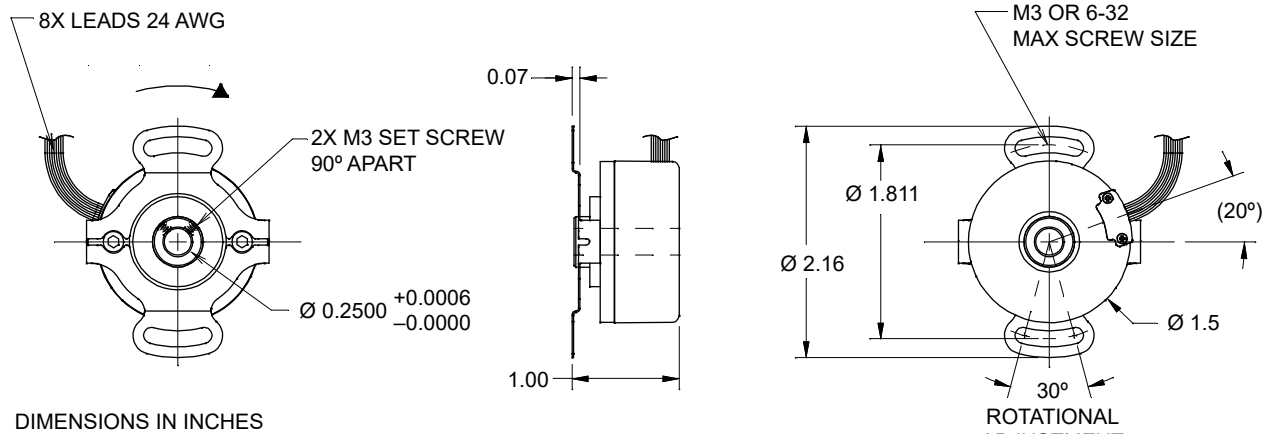

Encoder Connection

Function	Color Code
COM	Black
+5 V _{DC}	White
A	Brown
\bar{A}	Yellow
B	Red
\bar{B}	Green
Z (Index)	Orange
\bar{Z} (Index)	Blue

C2, C4, C5 Encoder Phase Diagram

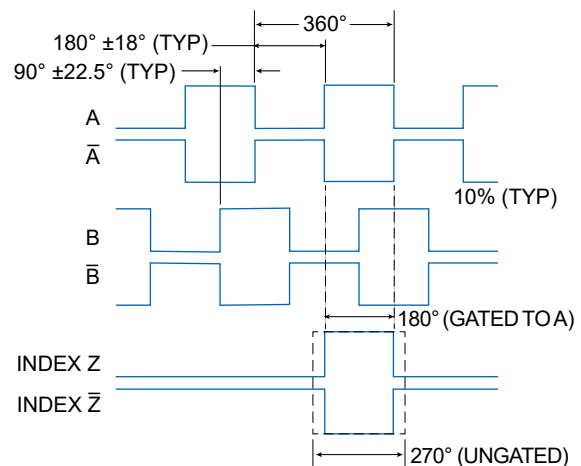

OUTPUT FORMAT FOR CCW ROTATION VIEWED FROM ENCODER END

▶ POWERMAX II® M and P Series

Ideally suited for lower loads, the POWERMAX II® M and P Series is designed to provide exceptional value, versatility and ease of use. Among the most powerful stepper motors available, they deliver high torque in a compact package and are available in a wide range of frame sizes, constructions, and optional modifications. POWERMAX II has an extremely competitive market lead time and is backed by UL and CE certifications.

Features

- » P2 models: NEMA 23 (60 mm) motors available in 3 stack lengths with torque ratings from 0.30 to 1.51 N-m (42 to 214 oz-in) nominal holding torque
- » M2 models: NEMA 23 (60 mm) motors available in 2 stack lengths with torque ratings from 0.67 to 1.79 N-m (95 to 253 oz-in) nominal holding torque
- » Available with affordable co-engineered modifications to suit your application needs, time frame and budget
- » Numerous standard modifications and customer-specified options
- » Speeds up to 3,000 rpm meet the velocity demands of most high-torque applications
- » Oversized 30 mm bearings increase bearing and motor life
- » Complete subassemblies available
- » UL, CE, RoHS and REACH certifications

Benefits

- » Broad product line with flexible modifications and rapid prototyping for exceptional design flexibility
- » Quality construction for reliability and long service life
- » Designed for quick, easy integration into new and existing applications
- » Global supply footprint with localized support
- » Competitive pricing and lead times

General Specifications

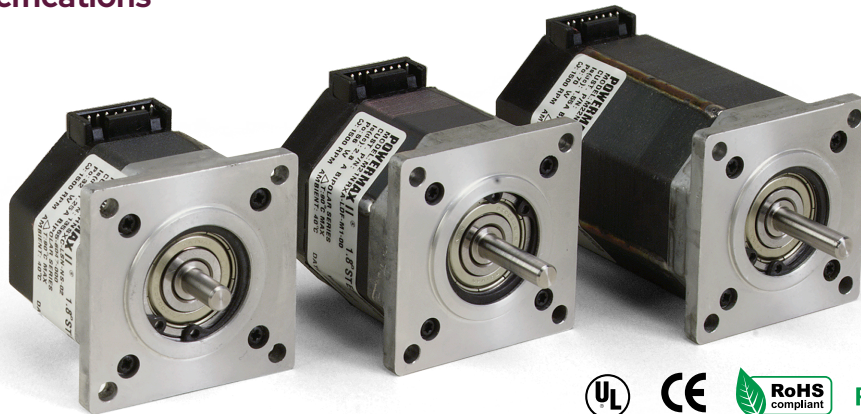

- » NEMA Size 23
- » Standard (P) and enhanced (M) using SIGMAX technology
- » Standard laminated and low inertia “J” rotors for maximum acceleration
- » Standard NEMA mounting
- » Oversized 30 mm bearings
- » UL, CE, RoHS, REACH Compliant
- » Unipolar or Bipolar windings
- » Standard Features: Shaft Flats or Keyways, Rear Shaft, Flying Leads or Motor-Mounted Connectors, Encoder Mounting Provisions, Incremental Encoders
- » Co-Engineered Options: Shaft Modifications, Special Windings, Lead Lengths, Connectors

Parameter	M / P
NEMA frame size	23
Windings	Unipolar and Bipolar
Full Steps per Revolution	200
Step Angle (degrees)	1.8
Step Accuracy % (of one full step, no load)	± 1.5% M / ± 3% P
Operating Temperature	-20° C to +40° C
Insulation Class	Class B, 130° C
Insulation Voltage (Vdc)	340
Insulation Resistance	100 Megohms

Rotor Inertia Characteristics

Single and double stack motors are available with both standard and low inertia “J” rotors. Choose low inertia to produce the highest acceleration rates possible. Low inertia motors are most effective for operation below 2,000 RPM. Choose standard to generate maximum torque.

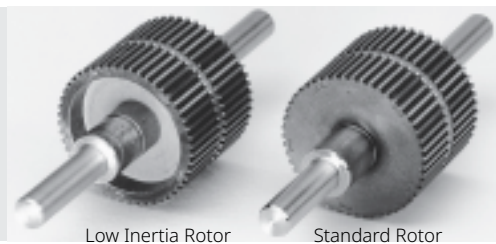

Low Inertia Rotor

Standard Rotor

M2 / P2 Series Stepper Motors

M2 / P2 Series Stepper Motor F, H, and L Connection Information

Integrated "X" Connector Option

"X"	Part Number
8 Lead	GW0000F
6 Lead	GW0000E
4 Lead Parallel	GW0000H
4 Lead Series	GW0000L

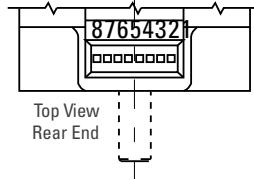

Typical Leaded Connector

4-lead shown

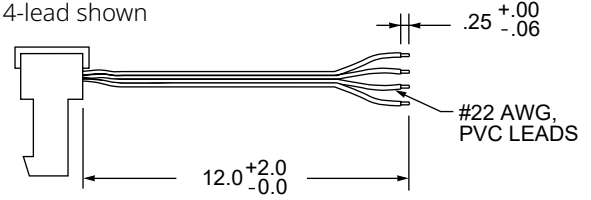

Optional Mating Connector Only

A separate mating connector or housing and strain relief cover are available from Kollmorgen or AMP. The user attaches leads to the connector.

Item	Kollmorgen	AMP
Standard Housing	GP00012	3-641653-8
Standard Cover	GP00013	643077-8

F (GW0000F) 8-Lead Configuration

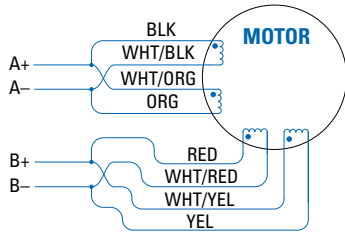

4-Lead Bipolar Connection Parallel

Driver Connection	Lead Color	Pin No.
A	Black & Wht/Org	6 & 5
\bar{A}	Org & Wht/Blk	1 & 2
B	Red & Wht/Yel	8 & 7
\bar{B}	Yel & Wht/Red	3 & 4

Bipolar Full Step Phase Sequence

STEP	A	\bar{A}	B	\bar{B}
1	+	-	-	+
2	-	+	-	+
3	-	+	+	-
4	+	-	+	-
1	+	-	-	+

CCW ↓ ↑ CW

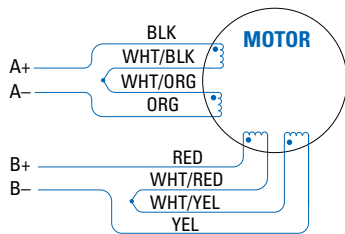

4-Lead Bipolar Connection Series

Driver Connection	Lead Color	Pin No.
A	Black (Blk)	6
\bar{A}	Orange (Org)	1
B	Red	8
\bar{B}	Yellow (Yel)	3
None	Wht/Blk & Wht/Org	2 & 5
None	Wht/Red & Wht/Yel	4 & 7

Unipolar Full Step Phase Sequence

STEP	A	B	C	D
1	GND	0	GND	0
2	0	GND	GND	0
3	0	GND	0	GND
4	GND	0	0	GND
1	GND	0	GND	0

CCW ↓ ↑ CW

6-Lead Unipolar Connection

Driver Connection	Lead Color	Pin No.
A	Black (Blk)	6
B	Orange (Org)	1
C	Red	8
D	Yellow (Yel)	3
V+	Wht/Blk & Wht/Org	2 & 5
V+	Wht/Red & Wht/Yel	4 & 7

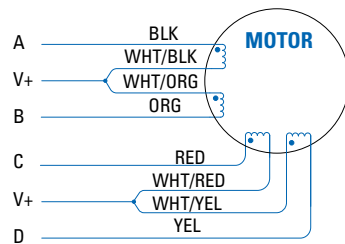

M/P Leaded Mating Connectors for "X" Integrated Connector Option

E (GW0000E) 6-Lead Configuration

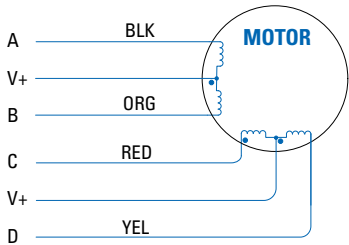

6-Lead Unipolar Connection

Driver Connection	Lead Color	Pin No.
A	Black (Blk)	6
B	Orange (Org)	1
C	Red	8
D	Yellow (Yel)	3
V+	Wht/Blk/Org	2 & 5
V+	Wht/Red/Yel	4 & 7

Unipolar Full Step Phase Sequence

STEP	A	B	C	D
1	GND	0	GND	0
2	0	GND	GND	0
3	0	GND	0	GND
4	GND	0	0	GND
1	GND	0	GND	0

↓
CCW
↓

 ↑
CW
↑

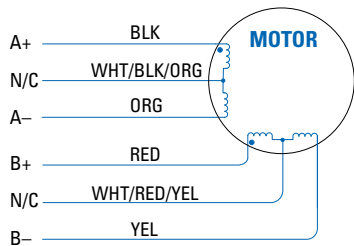

4-Lead Bipolar Series Connection

Driver Connection	Lead Color	Terminal Number
A	Black	6
\bar{A}	Orange	1
B	Red	8
\bar{B}	Yellow	3
N/C	Wht/Blk/Org	2 & 5
N/C	Wht/Red/Yel	4 & 7
Ground	Green/Yellow	n/a

Bipolar Full Step Phase Sequence

STEP	A	\bar{A}	B	\bar{B}
1	+	-	-	+
2	-	+	-	+
3	-	+	+	-
4	+	-	+	-
1	+	-	-	+

↓
CCW
↓

 ↑
CW
↑

H (GW0000H) and L (GW0000L) 4-Lead Configuration

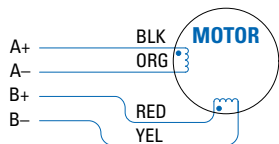

4-Lead Bipolar Connection

Driver Connection	Lead Color	Pin No. Series GW0000L	Pin No. Parallel GW0000H
A	Black	6	6 & 5
\bar{A}	Orange	1	1 & 2
B	Red	8	8 & 7
\bar{B}	Yellow	3	3 & 4
Ground	Green/Yellow	n/a	n/a

Optional Ground Wire

NOTES:

- ⚠️ GROUND LABEL PLACED IN FRONT OF GROUND SCREW.
- ⚠️ GREEN/YELLOW SAFETY EARTH CONDUCTOR (18AWG).

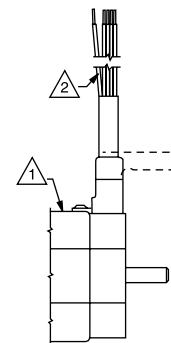

M2 / P2 Series Stepper Motors

M2 / P2 Series Stepper Motor Nomenclature

P 2 1 N R X A - L N N - NS - 00

Series

- P Standard
- M Enhanced (n/a half stack)

Frame Size

- 2 NEMA 23 (2.25 in. across flat)

Number of Stacks

- H Half stack
- 1 1 stack
- 2 2 stacks

Mounting

- N NEMA
- S Special, contact customer support

Construction

- R Regular
- S Special, contact customer support

Connections

- E 6 flying leads
 - F 8 flying leads
 - H 4 flying leads, parallel connection
 - L 4 flying leads, series connection
 - X Receptacle
 - S Special, contact customer support
- For X (receptacle) designation, Mating leaded connectors may be ordered separately. Optional GRN/YEL ground wire available.

Winding Type

- A, B, C, D
- S Special, contact customer support

Sequence Number

Insert 00 if all parts are standard
Other numbers will be assigned for special motors.

Encoder Option

NS No feedback
To use encoders below, you must specify shaft configuration D (double ended)

Caution: An encoder with line driver output may be required for use with some stepper motor controls.

- M1 Encoder mounting provisions
- HD Encoder 500 LPR
- HJ Encoder 512 LPR
- SS Special, contact customer support

Shaft Modifications

- N Smooth
- F Flat
- S Special, contact customer support

Shaft Configuration (Diameter & Length)

- N Single (no rear shaft extension)
- D Double (rear shaft extension)
- S Special, contact customer support

Rotor Type

- L Standard
- J Low inertia (n/a half stack)

M2 / P2 Series Outline Drawings

M2 / P2 Regular Construction Hookup

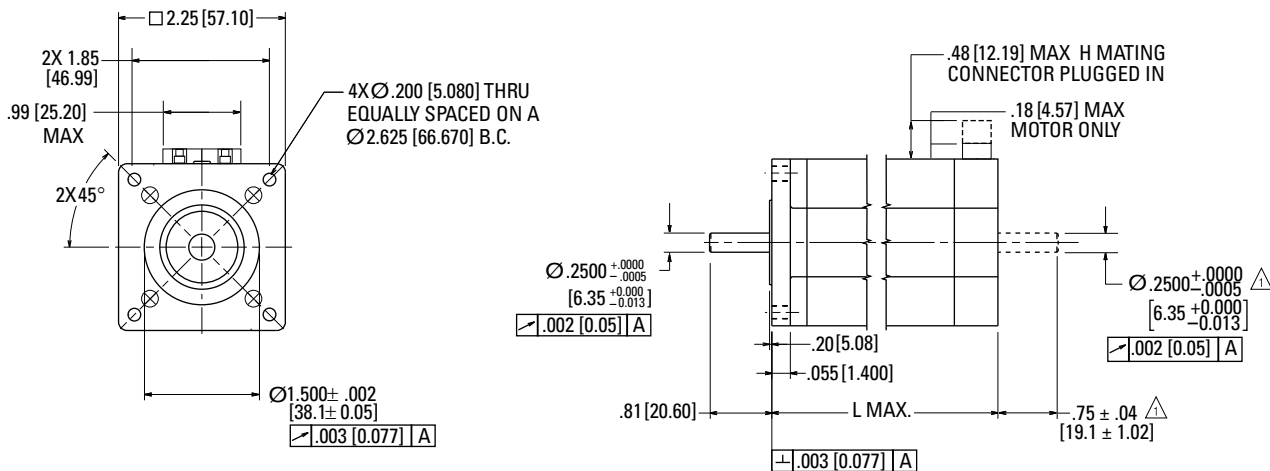

Integrated "X" Connector Option

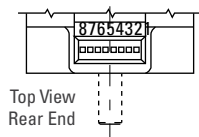

Δ Rear shaft extension "D" available as shown. Same diameter as front shaft extension.

Motor Model	L Max.
P2H	1.60 [40.7]
P or M21	2.06 [52.3]
P or M22	3.10 [78.7]

Standard Shaft Options

1. Shaft modifications also available.
2. Flat shaft "F" available on front shaft as shown.

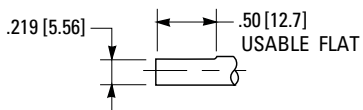

Encoder Option

See page 15 for more details

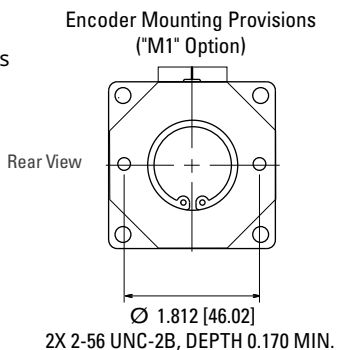

Dimensions in inches [mm]

M2 / P2 Series Stepper Motors

P2 Short Stack/ 1 Stack Performance Data

	Motor Model Number	Config.			Holding Torque (2 phases on) oz-in (Nm) +/-10%	Rated Current/Phase Amps DC	Phase Resistance Ohms +/-10%	Phase Inductance mH Typical	Thermal Resistance Mounted °C/Watt	Rotor Inertia oz-in-s ² (kg-m ² x 10 ⁻³)	Weight lb (kg)	Shaft Loading*	
		Parallel	Series	Unipolar								Radial Force lb (N)	Axial Force lb (N)
Short Stack	P2HxxHH-L	•			59 (0.42)	5.2	0.22	0.50	6.6	0.0010 (0.0071)	1.0 (0.45)	20 (89)	13 (58)
	P2HxxLH-L		•			2.6	0.90						
	P2HxxHB-L	•			59 (0.42)	2.6	0.76	1.9					
	P2HxxLB-L		•			1.3	3.04	7.6					
	P2HxxHC-L	•			61 (0.43)	2.5	0.84	2.3					
	P2HxxLC-L		•			1.25	3.36	9.2					
	P2HxxHF-L	•			60 (0.42)	1.61	1.92	5.1					
	P2HxxLF-L		•			0.8	7.68	20.4					
	P2HxxxH-L			•	42 (0.30)	3.68	0.44	0.50					
	P2HxxxB-L			•		1.84	1.52	1.9					
	P2HxxxC-L			•	43 (0.30)	1.77	1.68	2.3					
	P2HxxxF-L			•	42 (0.30)	1.1	3.84	5.1					
1 Stack	P21xxHA-L	•			114 (0.81)	5.6	0.23	0.80	5.5	0.0017 (0.012)	1.5 (0.68)	20 (89)	13 (58)
	P21xxLA-L		•			2.8	0.92	3.2					
	P21xxHB-L	•			111 (0.78)	4.6	0.32	1.1					
	P21xxLB-L		•			2.3	1.28	4.4					
	P21xxHC-L	•			116 (0.82)	3.5	0.53	2.3					
	P21xxLC-L		•			1.75	2.12	9.2					
	P21xxHD-L	•			109 (0.77)	1.51	2.61	10.3					
	P21xxLD-L		•			0.76	10.4	41.2					
	P21xxxA-L			•	81 (0.57)	4.0	0.46	0.80					
	P21xxxB-L			•	79 (0.56)	3.3	0.64	1.1					
	P21xxxC-L			•	82 (0.58)	2.5	1.06	2.3					
	P21xxxD-L			•	77 (0.54)	1.07	5.22	10.3					
Low Inertia	P21xxHA-J	•			111 (0.78)	5.6	0.23	0.90	5.5	0.0013 (0.0092)	1.5 (0.68)	20 (89)	13 (58)
	P21xxLA-J		•			2.8	0.92	3.6					
	P21xxxA-J			•	79 (0.56)	4.0	0.46	0.90					
	P21xxHB-J	•			108	4.6	0.33	1.2					
	P21xLLB-J		•		108	2.3	1.3	4.8					
	P21xxxB-J			•	76	3.3	0.65	1.2					
	P21xxHC-J	•			112	3.5	0.56	2.4					
	P21xxLC-J		•		112	1.75	2.22	9.6					
	P21xxxC-J			•	79	2.5	1.11	2.4					
	P21xxHD-J	•			106	1.51	2.63	10.4					
	P21xxLD-J		•		106	0.76	10.5	41.6					
	P21xxxD-J			•	75	1.07	5.25	10.4					

Note: *Maximum shaft loading based on 20,000 hours of operation at 1500 rpm.

M2 Enhanced 1 Stack Performance Data

	Motor Model Number	Config.			Holding Torque (2 phases on) oz-in (Nm) +/-10%	Rated Current/Phase Amps DC	Phase Resistance Ohms +/-10%	Phase Inductance mH Typical	Thermal Resistance Mounted °C/Watt	Rotor Inertia oz-in-s ² (kg-m ² x 10 ⁻³)	Weight lb (kg)	Shaft Loading*	
		Parallel	Series	Unipolar								Radial Force lb (N)	Axial Force lb (N)
Enhanced 1 Stack	M21xxHA-L	•			142 (1.00)	5.6	0.23	5.5	0.0017 (0.012)	1.5 (0.68)	20 (89)	13 (58)	
	M21xxLA-L		•			2.8	0.92						
	M21xxHB-L	•			137 (0.97)	4.6	0.32						
	M21xxLB-L		•			2.3	1.28						
	M21xxHC-L	•			144 (1.02)	3.5	0.53						
	M21xxLC-L		•			1.75	2.12						
	M21xxHD-L	•			135 (0.95)	1.51	2.61						
	M21xxLD-L		•			0.76	10.4						
	M21xxxA-L			•	100 (0.71)	4.0	0.46						
	M21xxxB-L			•	97 (0.68)	3.3	0.64						
	M21xxxC-L			•	102 (0.72)	2.5	1.06						
	M21xxxD-L			•	95 (0.67)	1.07	5.22						
Low Inertia	M21xxHA-J	•			140 (0.99)	5.6	0.23	5.5	0.0013 (0.0092)	1.5 (0.68)	20 (89)	13 (58)	
	M21xxLA-J		•			2.8	0.92						
	M21xxxA-J			•	99 (0.70)	4.0	0.46						
	M21xxHB-J	•			135	4.6	0.33						
	M21xxLB-J		•		135	2.3	1.3						
	M21xxxB-J			•	95	3.3	0.65						
	M21xxHC-J	•			142	3.5	0.56						
	M21xxLC-J		•		142	1.75	2.22						
	M21xxxC-J			•	100	2.5	1.11						
	M21xxHD-J	•			133	1.51	2.63						
	M21xxLD-J		•		133	0.76	10.5						
	M21xxxD-J			•	94	1.07	5.25						

Note: *Maximum shaft loading based on 20,000 hours of operation at 1500 rpm.

M2 / P2 Series Stepper Motors

P2 2 Stack Performance Data

Motor Model Number	Config.			Holding Torque (2 phases on)	Rated Current/ Phase	Phase Resistance	Phase Inductance	Thermal Resistance	Rotor Inertia	Weight	Shaft Loading*	
	Parallel	Series	Unipolar								oz-in (Nm) +/-10%	Amps DC
2 Stack	P22xxHA-L	•		197 (1.39)	6.5	0.21	0.80	4.5	0.0036 (0.025)	2.5 (1.13)	20 (89)	13 (58)
	P22xxLA-L		•		3.3	0.84	3.2					
	P22xxHB-L	•		214 (1.51)	4.6	0.38	2.1					
	P22xxLB-L		•		2.3	1.52	8.4					
	P22xxHC-L	•		203 (1.43)	3.1	0.78	3.9					
	P22xxLC-L		•		1.55	3.12	15.6					
	P22xxHD-L	•		203 (1.43)	2.5	1.22	6.2					
	P22xxLD-L		•		1.25	4.88	24.8					
	P22xxHE-L	•		195 (1.38)	1.64	2.7	12.6					
	P22xxLE-L		•		0.82	10.8	50.4					
	P22xxxA-L		•	139 (0.98)	4.6	0.42	0.80					
	P22xxxB-L		•	151 (1.07)	3.3	0.76	2.1					
	P22xxxC-L		•	144 (1.01)	2.2	1.56	3.9					
	P22xxxD-L		•	144 (1.01)	1.77	2.44	6.2					
	P22xxxE-L		•	138 (0.97)	1.16	5.4	12.6					
Low Inertia	P22xxHA-J	•		184	6.5	0.21	0.7	0.0026 (0.018)				
	P22xxLA-J		•		184	3.25	0.82					
	P22xxxA-J		•	130	4.6	0.41	0.7					
	P22xxHB-J	•		201	4.6	0.39	1.8					
	P22xxLB-J		•	201	2.3	1.54	7.2					
	P22xxxB-J		•	142	3.3	0.77	1.8					
	P22xxHC-J	•		190	3.1	0.79	3.4					
	P22xxLC-J		•	190	1.55	3.17	13.6					
	P22xxxC-J		•	134	2.2	1.59	3.4					
	P22xxHD-J	•		190	2.5	1.25	5.5					
	P22xxLD-J		•	190	1.25	4.98	22.0					
	P22xxxD-J		•	134	1.77	2.49	5.5					
	P22xxHE-J	•		182	1.64	2.73	11.1					
	P22xxLE-J		•	182	0.82	10.9	44.4					
	P22xxxE-J		•	129	1.16	5.45	11.1					

Note: *Maximum shaft loading based on 20,000 hours of operation at 1500 rpm.

M2 Enhanced 2 Stack Performance Data

	Motor Model Number	Config.			Holding Torque (2 phases on)	Rated Current/Phase	Phase Resistance	Phase Inductance	Thermal Resistance	Rotor Inertia	Weight	Shaft Loading*	
		Parallel	Series	Unipolar								Radial Force	Axial Force
					oz-in (Nm) +/-10%	Amps DC	Ohms +/-10%	mH Typical	Mounted °C/Watt	oz-in-s ² (kg-m ² x 10 ⁻³)	lb (kg)		
Enhanced 2 Stack	M22xxHA-L	•			230 (1.62)	6.5	0.21	0.70	4.5	0.0036 (0.025)	2.5 (1.13)	20 (89)	13 (58)
	M22xxLA-L		•			3.3	0.84	2.8					
	M22xxHB-L	•			253 (1.79)	4.6	0.38	1.7					
	M22xxLB-L		•			2.3	1.52	6.8					
	M22xxHC-L	•			238 (1.68)	3.1	0.78	3.1					
	M22xxLC-L		•			1.55	3.12	12.4					
	M22xxHD-L	•			238 (1.68)	2.5	1.22	5.0					
	M22xxLD-L		•			1.25	4.88	20					
	M22xxHE-L	•			227 (1.60)	1.64	2.71	10.1					
	M22xxLE-L		•			0.82	10.8	40.4					
	M22xxxA-L			•	163 (1.15)	4.6	0.42	0.70					
	M22xxxB-L			•	179 (1.26)	3.3	0.76	1.7					
	M22xxxC-L			•	168 (1.19)	2.2	1.56	3.1					
	M22xxxD-L			•	168 (1.19)	1.77	2.44	5.0					
	M22xxxE-L			•	161 (1.14)	1.16	5.42	10.1					
Low Inertia	M22xxHA-J	•			229	6.5	0.21	0.60	0.0026 (0.018)				
	M22xxLA-J		•		229	3.25	0.82	2.40					
	M22xxxA-J			•	162	4.6	0.41	0.60					
	M22xxHB-J	•			252	4.6	0.39	4.0					
	M22xxLB-J		•		252	2.3	1.54	16.0					
	M22xxxB-J			•	178	3.3	0.77	4.0					
	M22xxHC-J	•			237	3.1	0.79	2.8					
	M22xxLC-J		•		237	1.55	3.17	11.2					
	M22xxxC-J			•	166	2.2	1.59	2.8					
	M22xxHD-J	•			237	2.5	1.25	4.6					
	M22xxLD-J		•		237	1.25	4.98	18.4					
	M22xxxD-J			•	166	1.77	2.49	4.6					
	M22xxHE-J	•			226	1.64	2.73	9.3					
	M22xxLE-J		•		226	0.82	10.9	37.2					
	M22xxxE-J			•	160	1.16	5.45	9.3					

Note: *Maximum shaft loading based on 20,000 hours of operation at 1500 rpm.

M2 / P2 Series Stepper Motors

M2 / P2 Performance Curves

P2HxxxF-L (S) w/ P5000

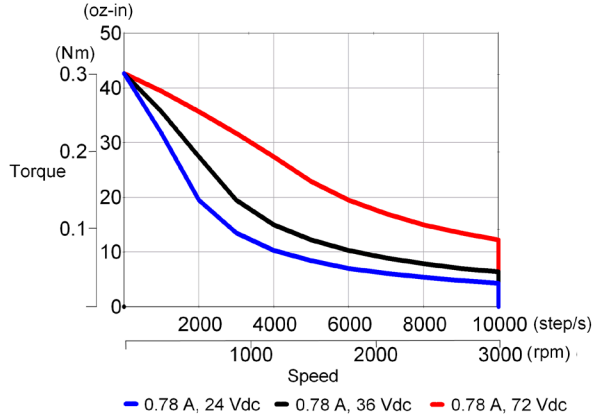

P2HxxxF-L (P) w/ P5000

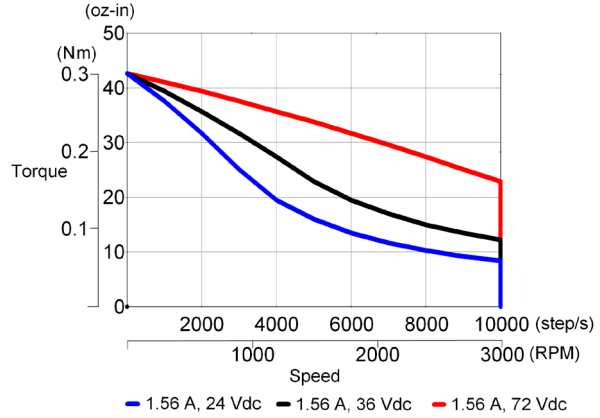

P2HxxxB-L (S) w/ P5000

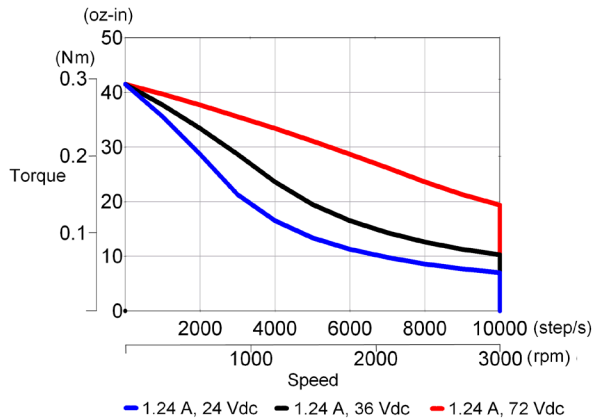

P2HxxxB-L (P) w/ P5000

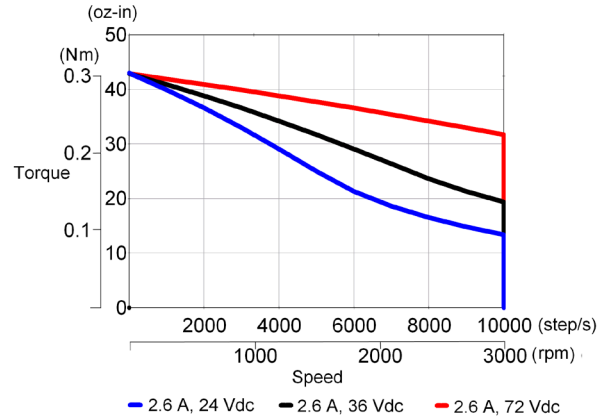

P21xxxD-L (P) w/ P5000

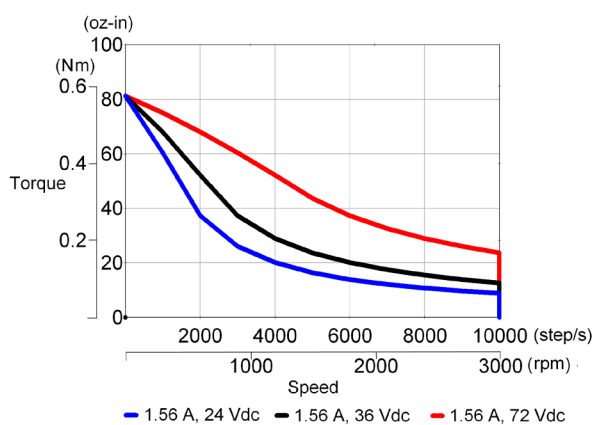

M21xxxD-L (P) w/ P5000

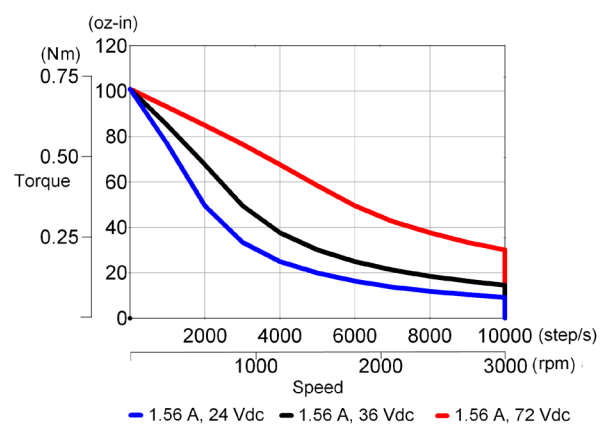

M2 / P2 Performance Curves

P21xxxA-L (S) w/ P5000

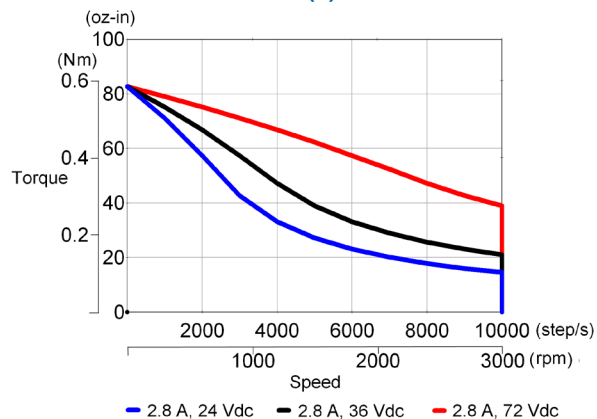

M21xxxA-L (S) w/ P5000

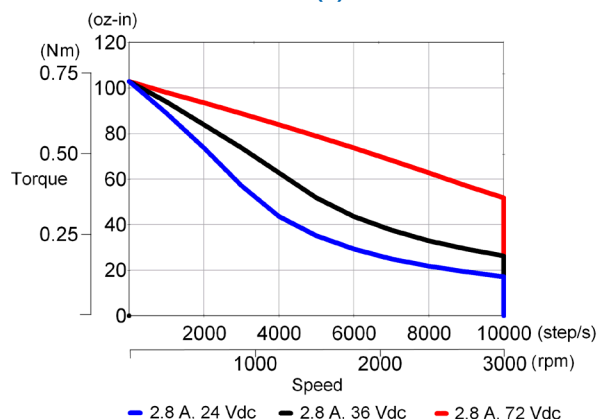

P22xxxE-L (S) w/ P5000

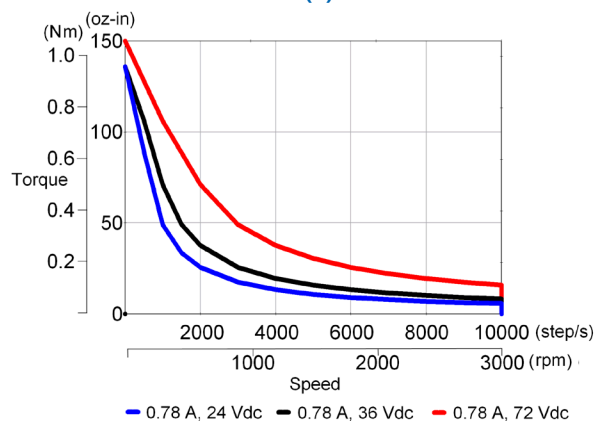

M22xxxE-L (S) w/ P5000

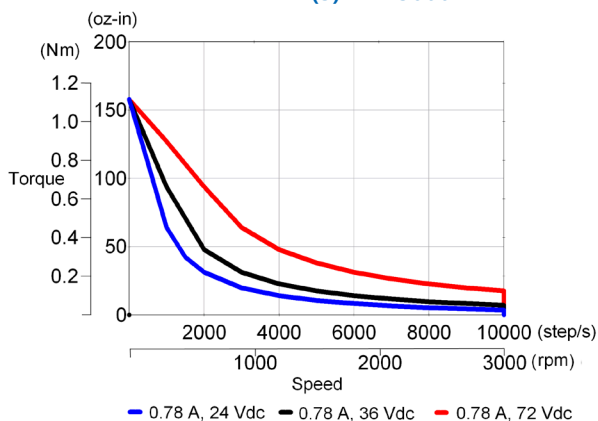

P22xxxC-L (S) w/ P5000

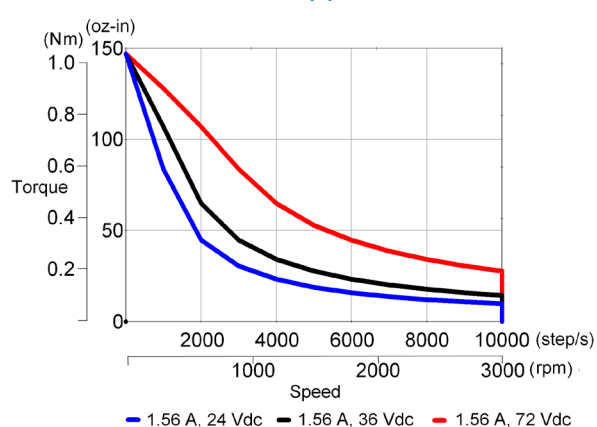

M22xxxC-L (S) w/ P5000

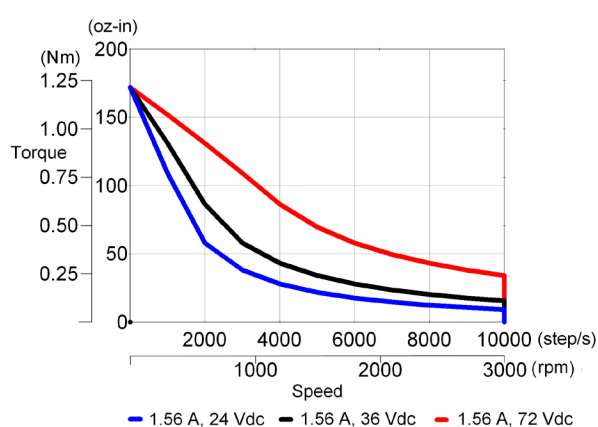

POWERPAC® K/N Series Stepper Motors

POWERPAC® hybrid stepper motors deliver more power in a smaller package. These rugged NEMA 34 and 42 (90 and 110 mm) motors combine optimal magnetics in a housingless frame with a large diameter rotor and innovative rotor-stator design to produce more torque and smoother microstepping. The K Series incorporates flux-focusing SIGMAX® technology for higher acceleration with 25 percent more torque.

Features

- » Wide range of standard options
- » Affordable co-engineered modifications with a short lead time to meet unique application requirements
- » N3 models, NEMA 34 (90 mm) motors are available in 4 stack lengths with torque ratings from 3.2 to 15.4 N-m (454 to 2,180 oz-in) nominal holding torque.
- » K3 models, NEMA 34 (90 mm) motors are available in 4 stack lengths with torque ratings from 4.08 to 19.7 N-m (578 to 2,790 oz-in) nominal holding torque.
- » N4 models, NEMA 42 (110 mm) motors are available in 3 stack lengths with torque ratings from 8.12 to 30.8 N-m (1,150 to 4,365 oz-in) nominal holding torque.
- » K4 models, NEMA 42 (110 mm) motors are available in 3 stack lengths with torque ratings from 10.4 to 40.3 N-m (1,470 to 5,700 oz-in) nominal holding torque.
- » Extensive selection of shaft configurations, terminations, windings and co-engineered modifications to suit your application needs, time frame and budget
- » Speeds up to 3,000 rpm meet the velocity demands of most high-torque applications
- » Improved torque linearity (above rated current) provides high peak torque to boost acceleration in intermittent-duty applications
- » High torque at moderate speeds to enable a cost-effective alternative to servo motors
- » Low detent torque harmonic provides smoother microstepping performance
- » K Series incorporates SIGMAX® technology for 25% more torque than N Series
- » Runs cooler than comparable steppers to provide longer, more reliable motor life
- » Special rotor design enables high acceleration
- » Rugged, "housingless" square frame means more torque in a smaller package
- » IP65 sealing for splashproof protection
- » Two-phase design is compatible with most drives and provides smoother microstepping and lower power input versus three-phase motors
- » Optional encoder mounting provisions

K/N Series

The K/N Series are larger step motors with the power, rugged construction, and options that make these motors ideal for heavy industrial applications. Options include: IP65, terminal boxes and MS connectors. Enhanced versions provide the maximum performance torque available. This patented technology boosts torque an additional 25% to 40%. Custom motors are available to meet specific application needs including: modified shafts, connectors, lead-screws, and components mounted to the shaft.

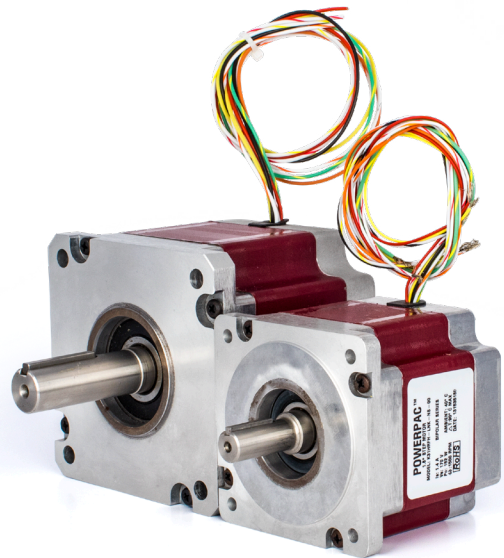

K/N Series Benefits

- » More torque to drive heavy loads
- » Smaller drives result in a lower system cost
- » Higher efficiency enables lower operating costs

Size 34 K/N

2 Phase, 1.8° Step Motors. Frame size: 3.4 inch, 87 mm

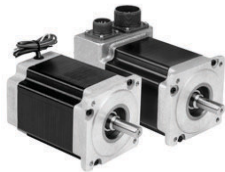

Series	Construction		Holding Torque (Motor Mounted)		Length	
	Style	Stacks	Bipolar		in	mm
			oz-in	Nm		
K31	Enhanced	1	830	5.9	3.7	94
K32		2	1530	10.8	5.22	133
K33		3	2200	15.6	6.74	171
K34		4	2770	19.6	8.25	210
N31	Un-Enhanced	1	650	4.6	3.7	94
N32		2	1220	8.6	5.22	133
N33		3	1760	12.4	6.74	171
N34		4	2170	15.3	8.25	210

- » Captured heavy duty bearings
- » High voltage insulation system
- » Options:
 - Terminal box
 - MS connectors
 - Rear shaft
 - Encoder
 - Front shaft seal

Size 42 K/N

2 Phase, 1.8° Step Motors. Frame size: 4.3 inch, 110 mm

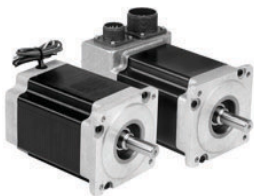

Series	Construction		Holding Torque (Motor Mounted)		Length	
	Style	Stacks	Bipolar		in	mm
			oz-in	Nm		
K41	Enhanced	1	2090	14.8	3.89	99
K42		2	4000	28.2	5.91	150
K43		3	5650	39.9	7.92	201
N41	Un-Enhanced	1	1630	11.5	3.89	99
N42		2	3140	22.2	5.91	150
N43		3	4340	30.6	7.92	201

- » Captured heavy duty bearings
- » High voltage insulation system
- » Options:
 - Terminal box
 - MS connectors
 - Rear shaft
 - Encoder
 - Front shaft seal

POWERPAC® K/N Series Stepper Motors

General Specifications

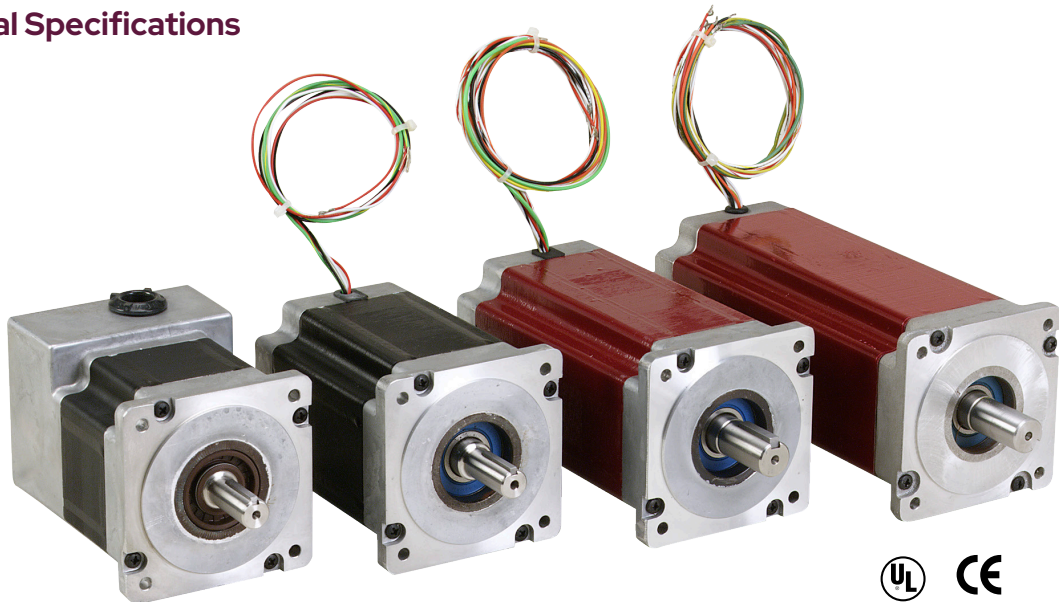

- » NEMA Sizes 34, 42
- » Standard (N) and enhanced (K) using SIGMAX technology
- » Standard NEMA mounting
- » UL, CE compliant
- » Unipolar or Bipolar windings
- » Standard Features: Shaft Flats or Keyways, Rear Shaft, Flying Leads or Motor-Mounted Connectors, Encoder Mounting Provisions, Incremental Encoders, Shaft Seals, Full IP65 Options
- » Co-Engineered Options: Shaft Modifications, Special Windings, Lead Lengths, Connectors

Phases	Bipolar and Unipolar
Full Steps per Revolution	200
Step Angle	1.8°
Step Accuracy (of one full step, no load)	± 1.5 % K3, K4 ± 3 % N3, N4
Operating Temperature	-20°C to +40°C
Insulation Class	Class B, 130°C
Insulation Voltage Rating	340 Vdc
Insulation Resistance	100 Megohms

K/N Series Stepper Motor Model Nomenclature

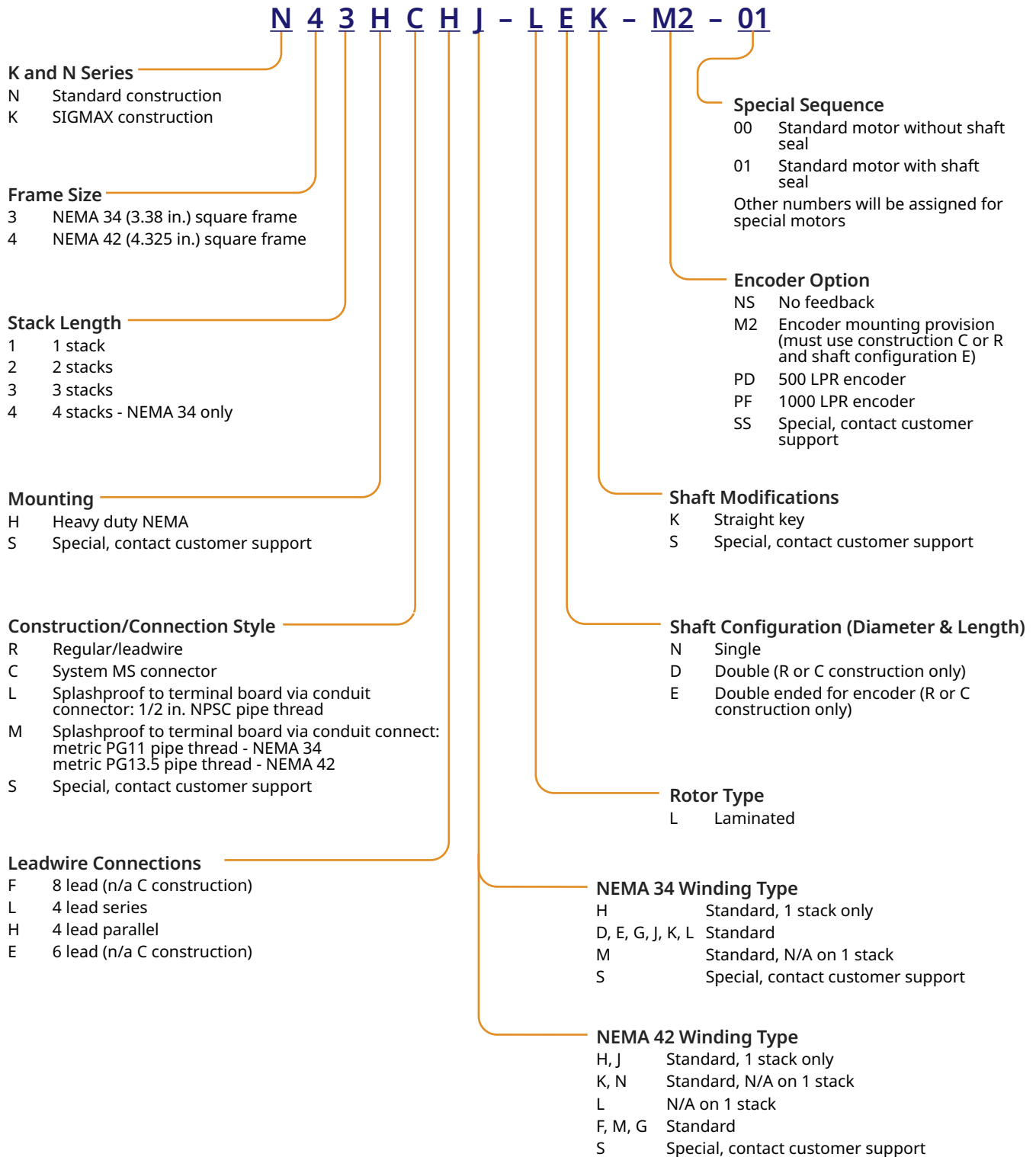

POWERPAC® K/N Series Stepper Motors

K/N Series Stepper Motor F (8 Lead) Connection Information

"F" 8-Lead Configuration

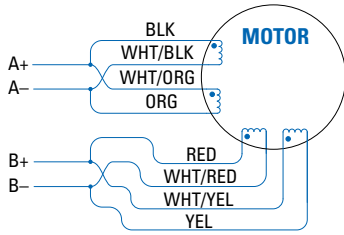

4-Lead Bipolar Connection Parallel

Driver Connection	Lead Color	Terminal Number
A	Black & Wht/Org	1 & 5
\bar{A}	Org & Wht/Blk	3 & 6
B	Red & Wht/Yel	2 & 7
\bar{B}	Yel & Wht/Red	4 & 8

Terminal Board

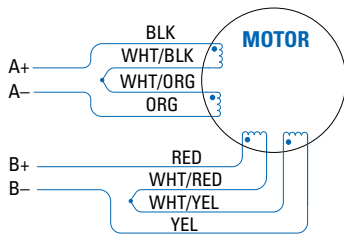
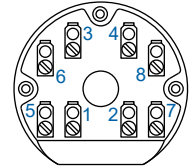

4-Lead Bipolar Connection Series

Driver Connection	Lead Color	Terminal Number
A	Black (Blk)	1
\bar{A}	Orange (Org)	3
B	Red	2
\bar{B}	Yellow (Yel)	4
None	Wht/Blk & Wht/Org	5 & 6
None	Wht/Red & Wht/Yel	7 & 8

Bipolar Full Step Phase Sequence

STEP	A	\bar{A}	B	\bar{B}
1	+	-	-	+
2	-	+	-	+
3	-	+	+	-
4	+	-	+	-
1	+	-	-	+

CCW ↓ ↑ CW

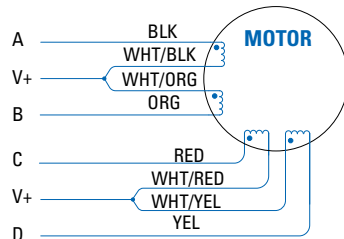

6-Lead Unipolar Connection

Driver Connection	Lead Color	Terminal Number
A	Black (Blk)	1
B	Orange (Org)	3
C	Red	2
D	Yellow (Yel)	4
V+	Wht/Blk & Wht/Org	5 & 6
V+	Wht/Red & Wht/Yel	7 & 8

Unipolar Full Step Phase Sequence

STEP	A	B	C	D
1	GND	0	GND	0
2	0	GND	GND	0
3	0	GND	0	GND
4	GND	0	0	GND
1	GND	0	GND	0

CCW ↓ ↑ CW

K/N Series Stepper Motor E (6 Lead) and H, L (4 Lead) Connection Information

"E" 6-Lead Configuration

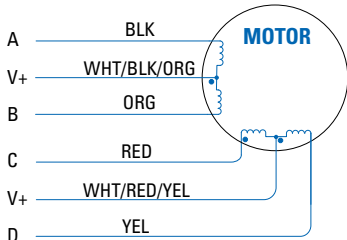

6-Lead Unipolar Connection

Driver Connection	Lead Color	Terminal Number
A	Black (Blk)	1
B	Orange (Org)	3
C	Red	2
D	Yellow (Yel)	4
V+	Wht/Blk/Org	5
V+	Wht/Red/Yel	6

Terminal Board

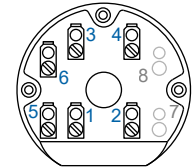

Unipolar Full Step Phase Sequence

STEP	A	B	C	D
1	GND	0	GND	0
2	0	GND	GND	0
3	0	GND	0	GND
4	GND	0	0	GND
1	GND	0	GND	0

CCW ↓ ↑ CW

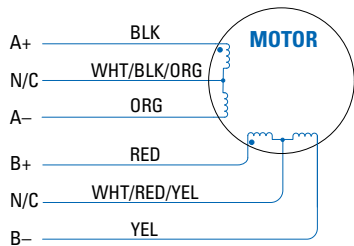

4-Lead Bipolar Series Connection

Driver Connection	Lead Color	Terminal Number
A	Black	1
\bar{A}	Orange	3
B	Red	2
\bar{B}	Yellow	4
N/C	Wht/Blk/Org	5
N/C	Wht/Red/Yel	6
Ground	Green/Yellow	n/a

Bipolar Full Step Phase Sequence

STEP	A	\bar{A}	B	\bar{B}
1	+	-	-	+
2	-	+	-	+
3	-	+	+	-
4	+	-	+	-
1	+	-	-	+

CCW ↓ ↑ CW

"H" "L" 4-Lead Configuration

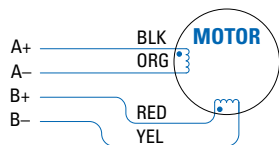

4-Lead Bipolar Connection

Driver Connection	Lead Color	Terminal Number	MS Connector Pinout
A	Black	1	A
\bar{A}	Orange	3	B
B	Red	2	C
\bar{B}	Yellow	4	D
Ground	Green/Yellow	n/a	E

Terminal Board

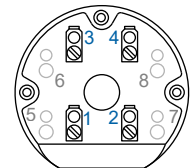

MS Connector
MS3102R14S-5P

Mating Plug Type
MS3106F14S-5S

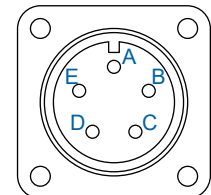

K3 / N3 Series Stepper Motors

K3 / N3 Outline Drawings

Leadwire Hookup

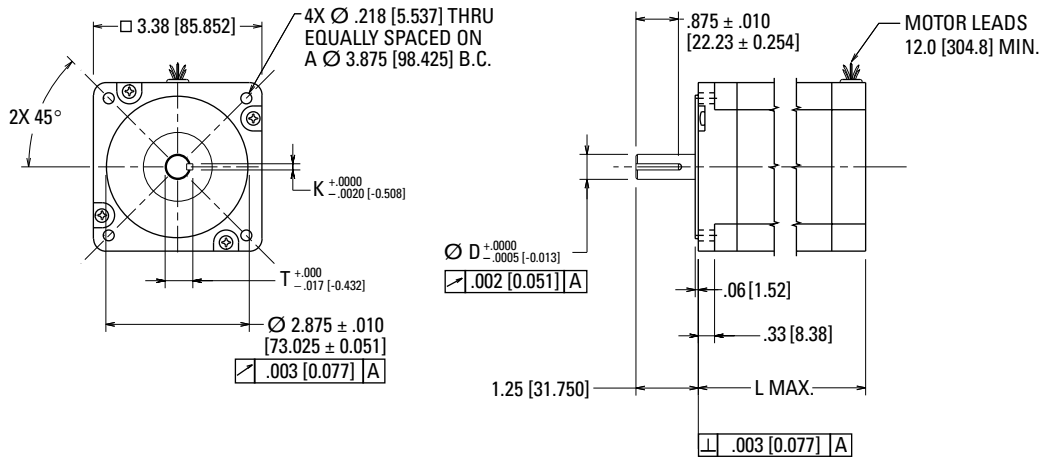

Model	"D"	"K"	"T"	"L" MAX
31HR	0.5000 (12.700)	0.1250 (3.175)	0.555 (14.097)	3.13 (79.502)
32HR				4.65 (118.11)
33HR	0.6250 (15.875)	0.1875 (4.763)	0.705 (17.907)	6.13 (155.70)
34HR				7.68 (195.07)

Dimensions in inches [mm]

Double Shaft Configuration

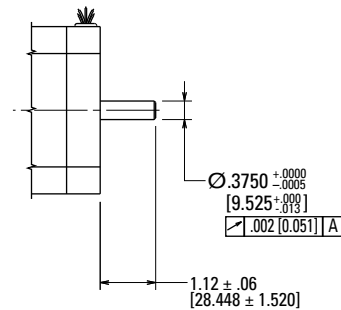

Encoder Mounting Provision

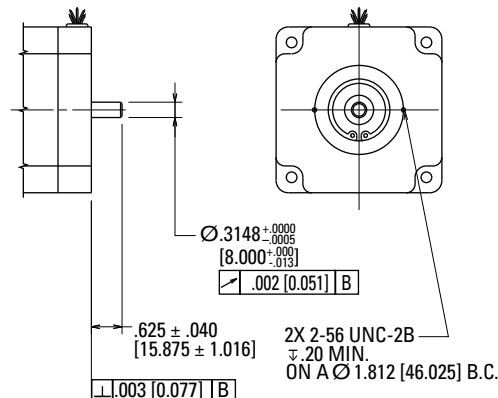

Dimensions in inches [mm]

K3 / N3 Outline Drawings

Splashproof Construction / Terminal Board Connections

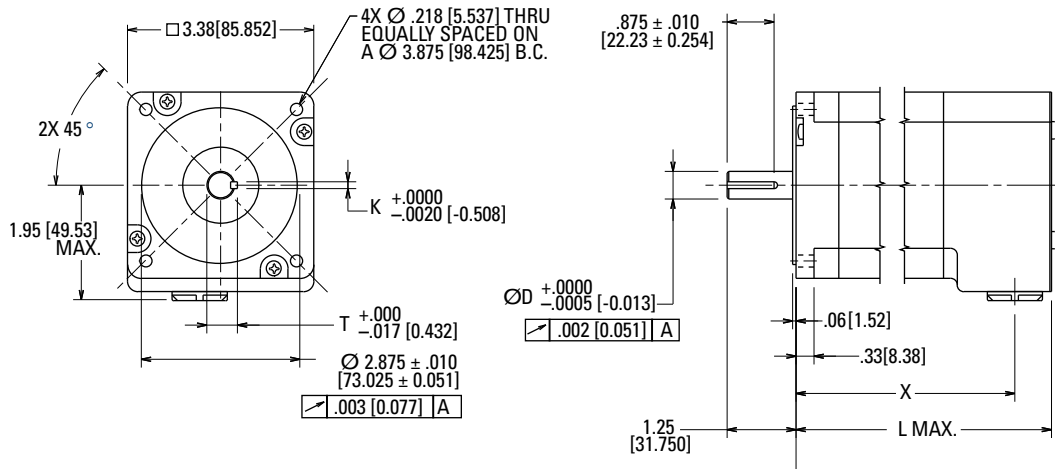

Dimensions in inches [mm]

Model	"D"	"K"	"T"	"X"	"L" MAX
31HL	0.5000 (12.700)	0.1250 (3.175)	0.555 (14.097)	3.70 (93.98)	4.44 (112.78)
32HL				5.22 (132.59)	5.96 (151.38)
33HL	0.6250 (15.875)	0.1875 (4.763)	0.705 (17.907)	6.74 (171.20)	7.48 (189.99)
34HL				8.25 (209.55)	8.99 (228.35)

K3 / N3 Series Stepper Motors

K3 / N3 Outline Drawings

Splashproof Construction / MS Connector(s)

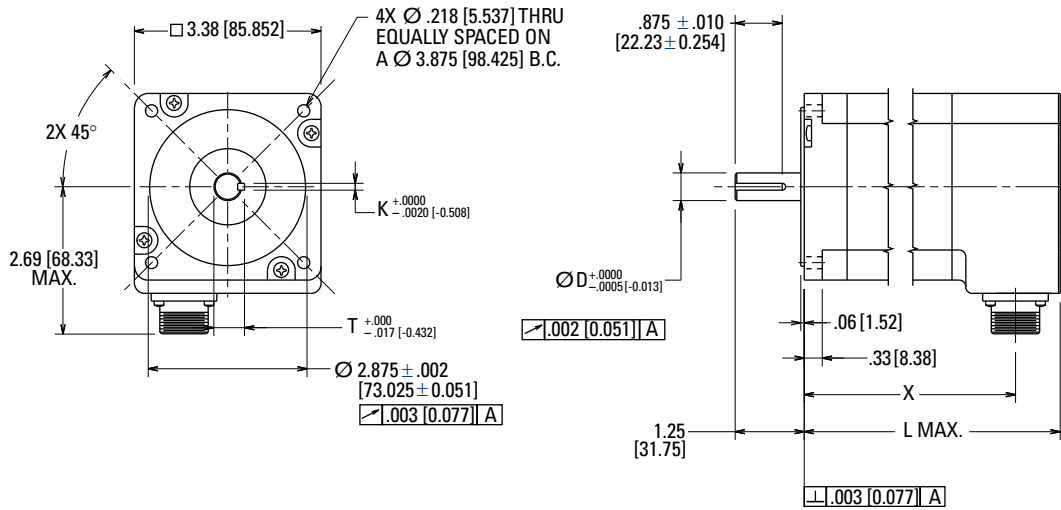

Dimensions in inches [mm]

Model	"D"	"K"	"T"	"X"	"L" MAX
31HC	0.5000	0.1250	0.555	3.56 (90.42)	4.44 (112.78)
32HC	(12.700)	(3.175)	(14.097)	5.07 (128.78)	5.96 (151.38)
33HC	0.6250	0.1875	0.705	6.59 (165.10)	7.48 (189.99)
34HC	(15.875)	(4.763)	(17.907)	8.11 (205.99)	8.99 (228.35)

Encoder Mounting Option

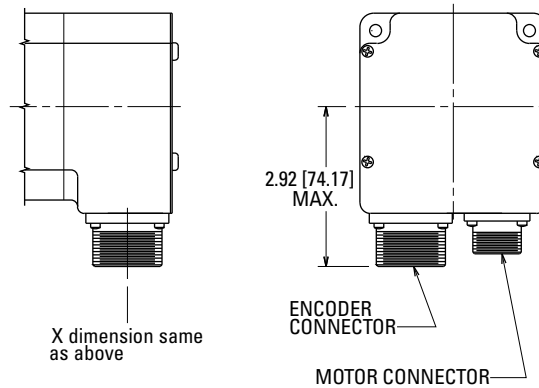

Notes

N - Motor Series
4 - Frame Size
2 - Stack Length
H - Mounting
R - Construction
L - Lead Connection
G - Winding Type
-
L - Rotor Type
N - Shaft Cfg.
N - Shaft Mod.
-
NS - Encoder Opt.
-
00 - Customization

0.125 inch divisions

K3 / N3 Series Stepper Motors

K3 / N3 1 Stack Performance Data

	Motor Model Number	Config.			Holding Torque (2 phases on) oz-in (Nm) +/-10%	Rated Current/Phase Amps DC	Phase Resistance Ohms +/-10%	Phase Inductance mH Typical	Thermal Resistance Mounted °C/Watt	Rotor Inertia oz-in-s ² (kg-m ² x 10 ⁻³)	Weight lb (kg)	Shaft Loading	
		Parallel	Series	Unipolar								Radial Force lb (N)	Axial Force lb (N)
1 Stack	N31xxHL-L	•			650 (4.59)	8.6	0.18	1.4	2.7	0.0202 (0.14)	5.0 (2.3)	65 (289)	305 (1360)
	N31xxLL-L		•			4.3	0.72	5.8					
	N31xxHK-L	•			665 (4.69)	6.6	0.29	2.6					
	N31xxLK-L		•			3.3	1.16	10.3					
	N31xxHJ-L	•			645 (4.55)	5.5	0.42	3.5					
	N31xxLJ-L		•			2.7	1.69	14					
	N31xxHH-L	•			635 (4.48)	2.8	1.55	12.5					
	N31xxLH-L		•			1.4	6.21	50.1					
	N31xxHG-L	•			641 (4.52)	1.73	4.06	34.5					
	N31xxLG-L		•			0.86	16.2	138					
	N31xxEL-L			•	460 (3.25)	6.1	0.36	1.4					
	N31xxEK-L			•	470 (3.32)	4.7	0.58	2.6					
	N31xxEJ-L			•	455 (3.21)	3.9	0.84	3.5					
	N31xxEH-L			•	450 (3.18)	2.0	3.10	12.5					
N31xxEG-L			•	453 (3.20)	1.22	8.12	34.5						
Enhanced 1 Stack	K31xxHL-L	•			830 (5.86)	8.6	0.18	1.2	2.7	0.0202 (0.14)	5.0 (2.3)	65 (289)	305 (1360)
	K31xxLL-L		•			4.3	0.72	4.7					
	K31xxHK-L	•			845 (5.96)	6.6	0.29	2.1					
	K31xxLK-L		•			3.3	1.16	8.3					
	K31xxHJ-L	•			820 (5.79)	5.5	0.42	2.8					
	K31xxLJ-L		•			2.7	1.69	11.4					
	K31xxHH-L	•			805 (5.68)	2.8	1.55	10.2					
	K31xxLH-L		•			1.4	6.21	40.7					
	K31xxHG-L	•			816 (5.76)	1.73	4.06	28.1					
	K31xxLG-L		•			0.86	16.2	112					
	K31xxEL-L			•	590 (4.16)	6.1	0.36	1.2					
	K31xxEK-L			•	600 (4.23)	4.7	0.58	2.1					
	K31xxEJ-L			•	580 (4.09)	3.9	0.84	2.8					
	K31xxEH-L			•	570 (4.03)	2.0	3.10	10.2					
K31xxEG-L			•	577 (4.08)	1.22	8.12	28.1						

K3 / N3 2 Stack Performance Data

	Motor Model Number	Config.			Holding Torque (2 phases on) oz-in (Nm) +/-10%	Rated Current/Phase Amps DC	Phase Resistance Ohms +/-10%	Phase Inductance mH Typical	Thermal Resistance Mounted °C/Watt	Rotor Inertia oz-in-s ² (kg-m ² x 10 ⁻³)	Weight lb (kg)	Shaft Loading	
		Parallel	Series	Unipolar								Radial Force lb (N)	Axial Force lb (N)
2 Stack	N32xxHD-L	•			1195 (8.45)	3.2	1.57	16.5	2.0	0.038 (0.27)	8.4 (3.8)	65 (289)	305 (1360)
	N32xxLD-L		•			1.6	6.30	66.1					
	N32xxHM-L	•			1215 (8.58)	10	0.18	1.8					
	N32xxLM-L		•			5.0	0.70	7.0					
	N32xxHL-L	•			1200 (8.47)	8.1	0.26	2.6					
	N32xxLL-L		•			4.1	1.03	10.3					
	N32xxHK-L	•			1245 (8.79)	6.1	0.45	5.1					
	N32xxLK-L		•			3.0	1.80	20.6					
	N32xxHJ-L	•			1195 (8.43)	5.1	0.63	6.5					
	N32xxLJ-L		•			2.5	2.53	26					
	N32xxHG-L	•			1240 (8.76)	1.91	4.41	51.6					
	N32xxLG-L		•			0.95	17.6	206					
	N32xxED-L			•	845 (5.97)	2.3	3.15	16.5					
	N32xxEM-L			•	860 (6.07)	7.1	0.35	1.8					
	N32xxEL-L			•	850 (6.00)	5.8	0.52	2.6					
	N32xxEK-L			•	885 (6.25)	4.3	0.90	5.1					
N32xxEJ-L			•	845 (5.96)	3.5	1.27	6.5						
N32xxEG-L			•	887 (6.19)	1.35	8.82	51.6						
Enhanced 2 Stack	K32xxHD-L	•			1510 (10.7)	3.2	1.57	13.0	2.0	0.038 (0.27)	8.4 (3.8)	65 (289)	305 (1360)
	K32xxLD-L		•			1.6	6.30	51.9					
	K32xxHM-L	•			1535 (10.8)	10	0.18	1.4					
	K32xxLM-L		•			5.0	0.70	5.5					
	K32xxHL-L	•			1515 (10.7)	8.1	0.26	2.0					
	K32xxLL-L		•			4.1	1.03	8.1					
	K32xxHK-L	•			1580 (11.2)	6.1	0.45	4.0					
	K32xxLK-L		•			3.0	1.8	16.2					
	K32xxHJ-L	•			1510 (10.7)	5.1	0.63	5.1					
	K32xxLJ-L		•			2.5	2.53	20.5					
	K32xxHG-L	•			1570 (11.1)	1.91	4.41	51.6					
	K32xxLG-L		•			0.95	17.6	162					
	K32xxED-L			•	1065 (7.53)	2.3	3.15	13.0					
	K32xxEM-L			•	1085 (7.66)	7.1	0.35	1.4					
	K32xxEL-L			•	1070 (7.55)	5.8	0.52	2.0					
	K32xxEK-L			•	1120 (7.90)	4.3	0.90	4.0					
	K32xxEJ-L			•	1065 (7.52)	3.5	1.27	5.1					
	K32xxEG-L			•	1110 (7.85)	1.35	8.82	40.5					

K3 / N3 Series Stepper Motors

K3 / N3 3 Stack Performance Data

Motor Model Number	Config.			Holding Torque (2 phases on) oz-in (Nm) +/-10%	Rated Current/Phase Amps DC	Phase Resistance Ohms +/-10%	Phase Inductance mH Typical	Thermal Resistance Mounted °C/Watt	Rotor Inertia oz-in-s ² (kg-m ² x 10 ⁻³)	Weight lb (kg)	Shaft Loading	
	Parallel	Series	Unipolar								Radial Force lb (N)	Axial Force lb (N)
3 Stack	N33xxHE-L	•		1700 (12.0)	4.0	1.27	13.6	1.6	0.0567 (0.40)	11.9 (5.39)	110 (489)	305 (1360)
	N33xxLE-L		•		2.0	5.06	54.5					
	N33xxHM-L	•		1715 (12.1)	9.9	0.22	2.3					
	N33xxLM-L		•		5.0	0.87	9.0					
	N33xxHL-L	•		1845 (13.0)	9.0	0.26	3.4					
	N33xxLL-L		•		4.5	1.06	13.6					
	N33xxHK-L	•		1755 (12.4)	6.1	0.56	6.4					
	N33xxLK-L		•		3.0	2.23	25.8					
	N33xxHJ-L	•		1710 (12.1)	5.0	0.83	9.0					
	N33xxLJ-L		•		2.5	3.31	36					
	N33xxHG-L	•		1710 (12.1)	2.50	3.25	36					
	N33xxLG-L		•		1.24	13.1	144					
	N33xxEE-L		•	1200 (8.47)	2.8	2.53	13.6					
	N33xxEM-L		•	1215 (8.58)	7.0	0.44	2.3					
	N33xxEL-L		•	1305 (9.21)	6.3	0.53	3.4					
	N33xxEK-L		•	1240 (8.75)	4.3	1.12	6.4					
N33xxEJ-L		•	1210 (8.54)	3.5	1.65	9.0						
N33xxEG-L		•	1210 (8.55)	1.75	6.51	36						
Enhanced 3 Stack	K33xxHE-L	•		2125 (15.0)	4.0	1.27	10.6	1.6	0.0567 (0.40)	11.9 (5.39)	110 (489)	305 (1360)
	K33xxLE-L		•		2.0	5.06	42.2					
	K33xxHM-L	•		2150 (15.2)	9.9	0.22	1.7					
	K33xxLM-L		•		5.0	0.87	7.0					
	K33xxHL-L	•		2340 (16.5)	9.0	0.26	2.6					
	K33xxLL-L		•		4.5	1.06	10.6					
	K33xxHK-L	•		2205 (15.6)	6.1	0.56	5.0					
	K33xxLK-L		•		3.0	2.23	19.9					
	K33xxHJ-L	•		2145 (15.1)	5.0	0.83	7.0					
	K33xxLJ-L		•		2.5	3.31	27.9					
	K33xxHG-L	•		2145 (15.1)	2.5	3.25	27.9					
	K33xxLG-L		•		1.24	13.1	111					
	K33xxEE-L		•	1505 (10.6)	2.8	2.53	10.6					
	K33xxEM-L		•	1520 (10.7)	7.0	0.44	1.7					
	K33xxEL-L		•	1655 (11.7)	6.3	0.53	2.6					
	K33xxEK-L		•	1560 (11.0)	4.3	1.12	5.0					
K33xxEJ-L		•	1515 (10.7)	3.5	1.65	7.0						
K33xxEG-L		•	1515 (10.7)	1.75	6.51	27.9						

K3 / N3 4 Stack Performance Data

	Motor Model Number	Config.			Holding Torque (2 phases on) oz-in (Nm) +/-10%	Rated Current/Phase Amps DC	Phase Resistance Ohms +/-10%	Phase Inductance mH Typical	Thermal Resistance Mounted °C/Watt	Rotor Inertia oz-in-s ² (kg-m ² x 10 ⁻³)	Weight lb (kg)	Shaft Loading	
		Parallel	Series	Unipolar								Radial Force lb (N)	Axial Force lb (N)
4 Stack	N34xxHM-L	•			2140 (15.1)	11.3	0.20	2.6	1.3	0.075 (0.53)	15.1 (6.85)	110 (489)	305 (1360)
	N34xxLM-L		•			5.6	0.82	10.6					
	N34xxHL-L	•			2180 (15.4)	8.7	0.33	4.7					
	N34xxLL-L		•			4.4	1.32	18.8					
	N34xxHK-L	•			2035 (14.4)	6.0	0.67	8.1					
	N34xxLK-L		•			3.0	2.69	32.4					
	N34xxHJ-L	•			2170 (15.3)	5.5	0.80	11.5					
	N34xxLJ-L		•			2.8	3.19	45.9					
	N34xxHG-L	•			2170 (15.3)	3.5	2.0	29.4					
	N34xxLG-L		•			1.7	8.0	117					
	N34xxEM-L			•	1510 (10.7)	8.0	0.41	2.6					
	N34xxEL-L			•	1545 (10.9)	6.2	0.66	4.7					
	N34xxEK-L			•	1440 (10.2)	4.3	1.35	8.1					
N34xxEJ-L			•	1535 (10.8)	3.9	1.6	11.5						
N34xxEG-L			•	1535 (10.8)	2.5	4.0	29.4						
Enhanced 4 Stack	K34xxHM-L	•			2725 (19.2)	11.3	0.20	2.0	1.3	0.075 (0.53)	15.5 (6.85)	110 (489)	305 (1360)
	K34xxLM-L		•			5.6	0.82	8.2					
	K34xxHL-L	•			2790 (19.7)	8.7	0.33	3.6					
	K34xxLL-L		•			4.4	1.32	14.5					
	K34xxHK-L	•			2580 (18.2)	6.0	0.67	6.3					
	K34xxLK-L		•			3.0	2.69	25.1					
	K34xxHJ-L	•			2770 (19.6)	5.5	0.80	8.9					
	K34xxLJ-L		•			2.8	3.19	35.5					
	K34xxHG-L	•			2780 (19.6)	3.5	2.0	22.7					
	K34xxLG-L		•			1.7	8.0	91					
	K34xxEM-L			•	1930 (13.6)	8.0	0.41	2.0					
	K34xxEL-L			•	1975 (13.9)	6.2	0.66	3.6					
	K34xxEK-L			•	1825 (12.9)	4.3	1.35	6.3					
	K34xxEJ-L			•	1960 (13.8)	3.9	1.6	8.9					
K34xxEG-L			•	1965 (13.9)	2.5	4.0	22.7						

K3 / N3 Series Stepper Motors

K3/N3 Performance Curves

N31xxHJ-L w/ P70530

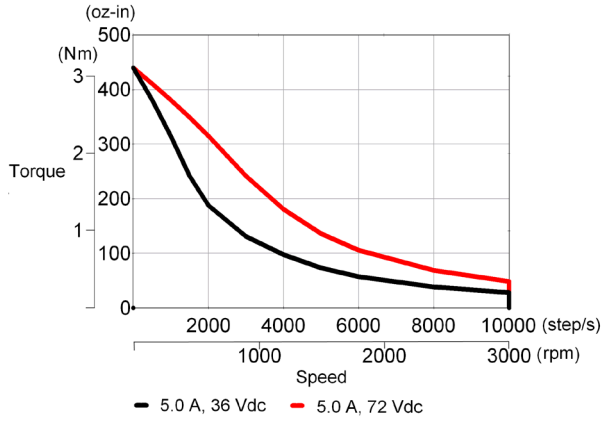

K31xxHJ-L w/ P70530

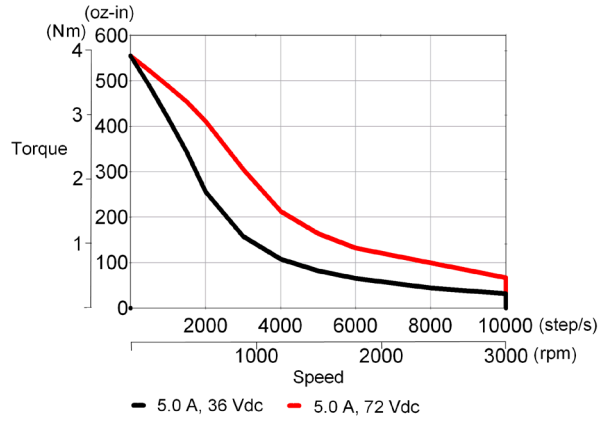

N32xxHJ-L w/ P70530

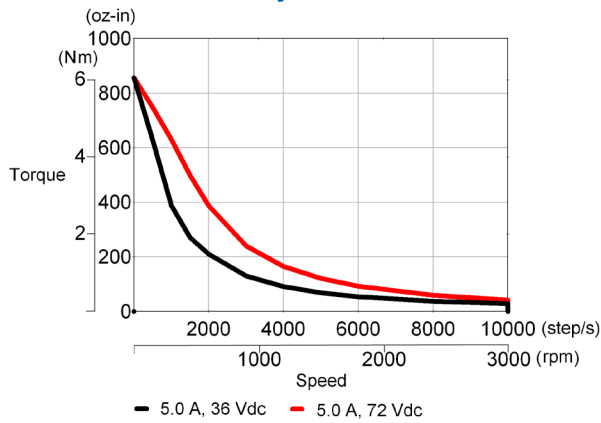

K32xxHJ-L w/ P70530

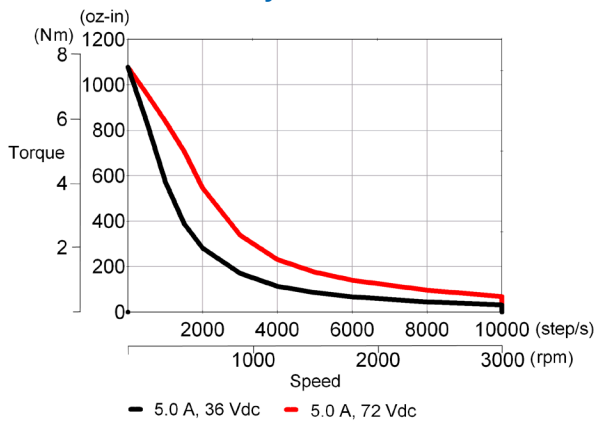

N33xxHJ-L w/ P70530

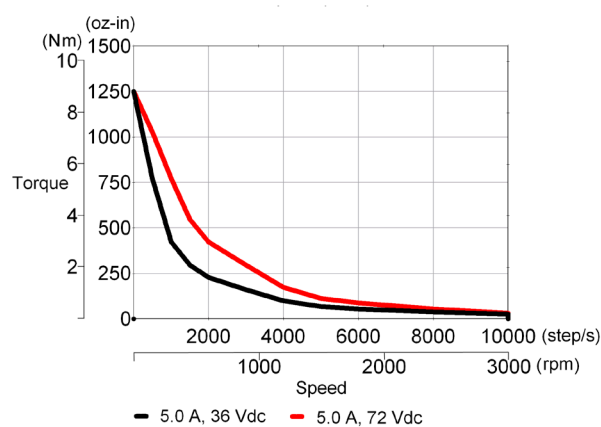

K33xxHJ-L w/ P70530

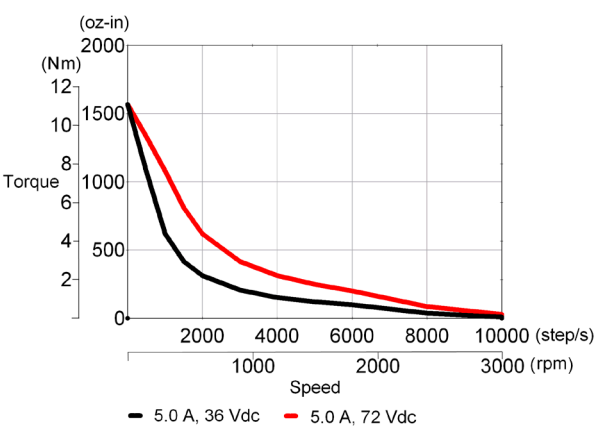

K3/N3 Performance Curves

N34xxHJ-L w/ P70530

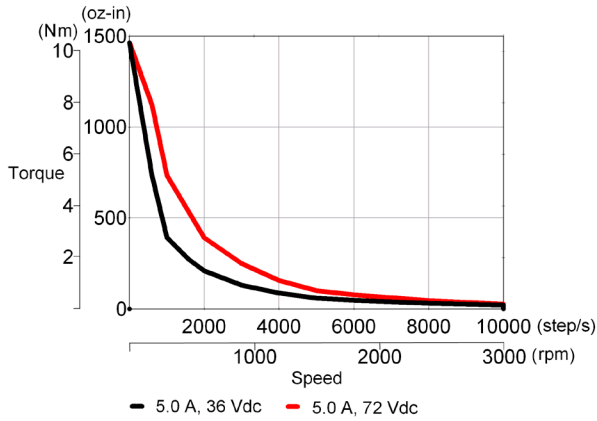

K34xxHJ-L w/ P70530

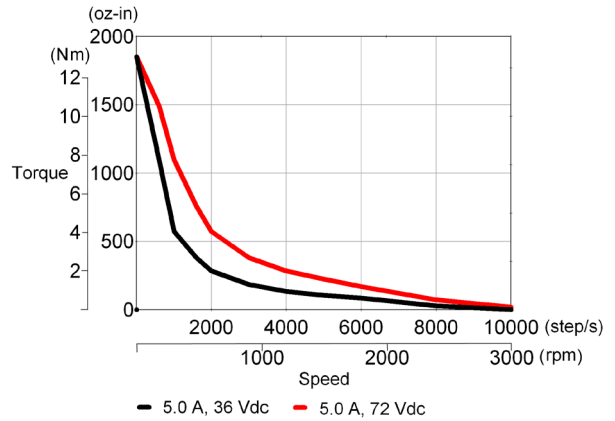

N31xxxH-L w/ P6000

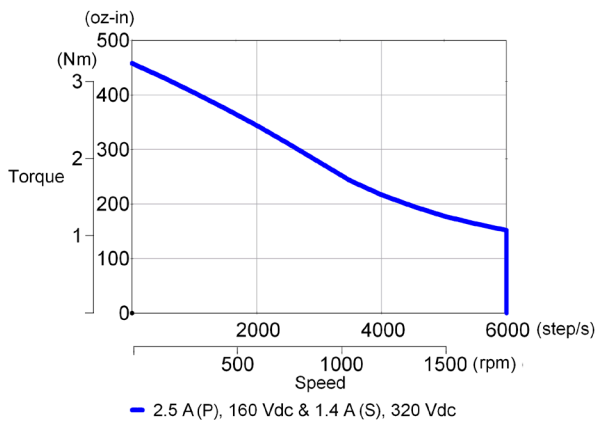

K31xxxH-L w/ P6000

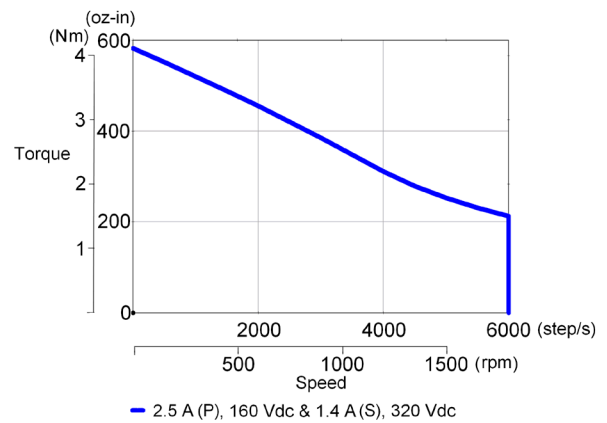

N31xxLG-L w/ P70360

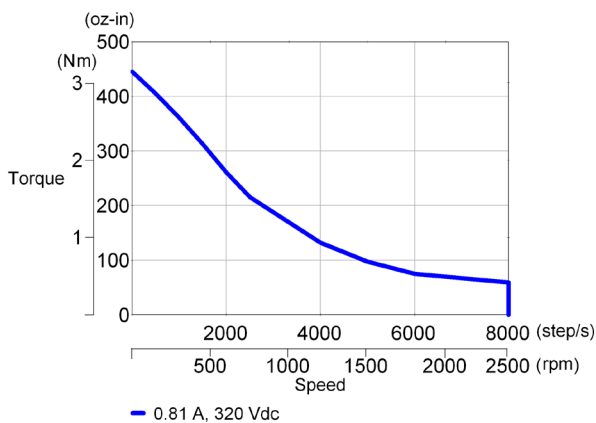

K31xxLG-L (P) w/ P70360

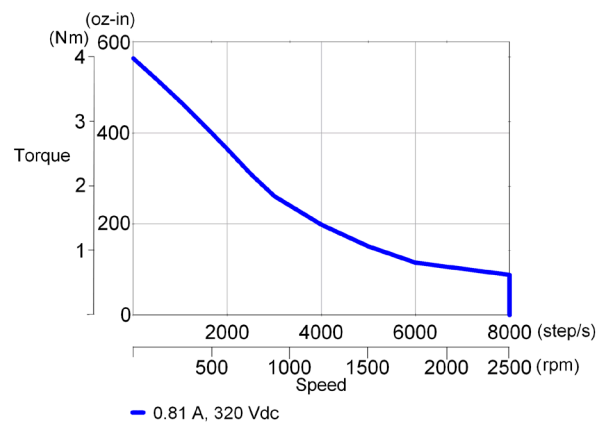

K3 / N3 Series Stepper Motors

K3/N3 Performance Curves

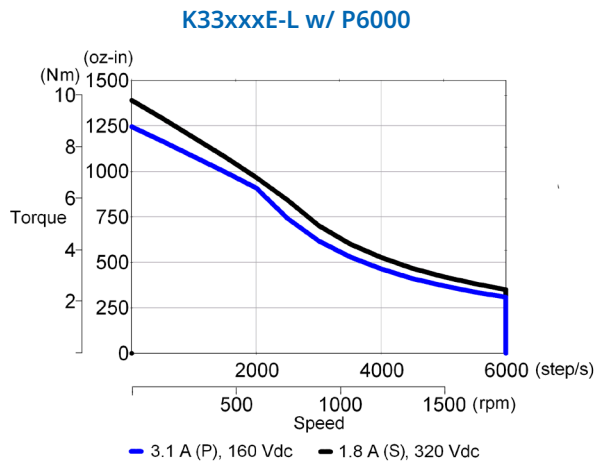
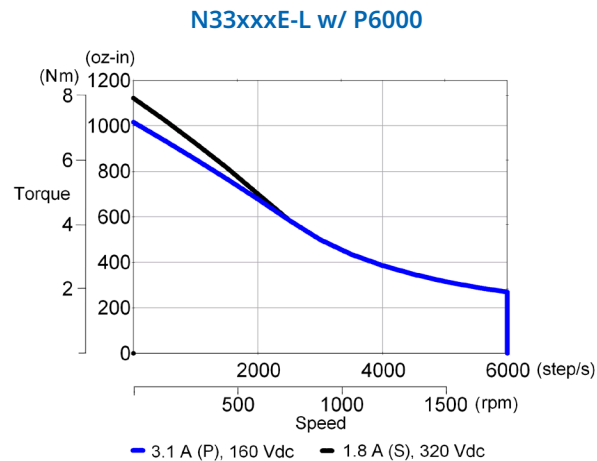
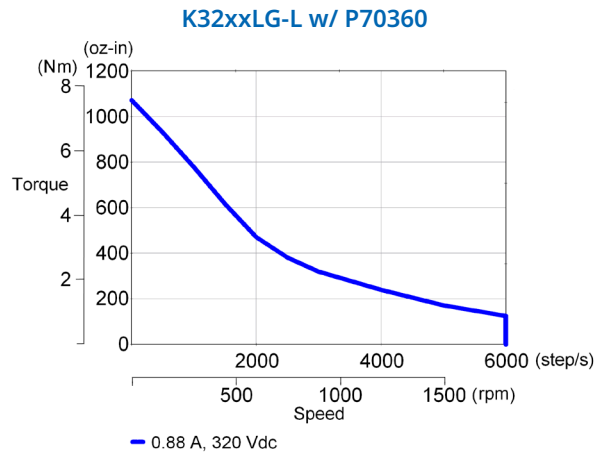
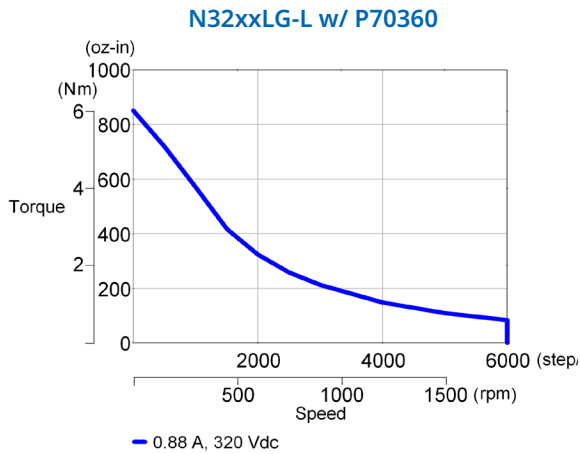
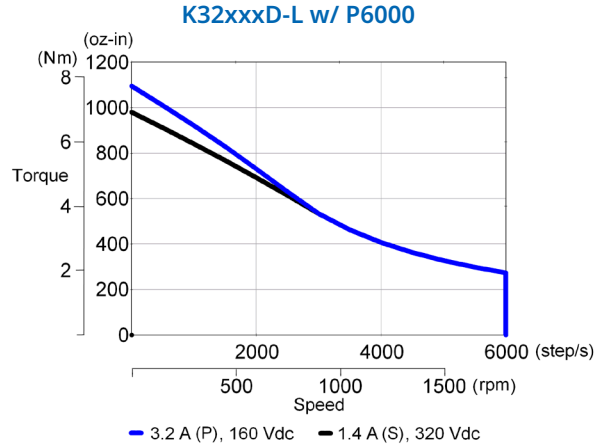
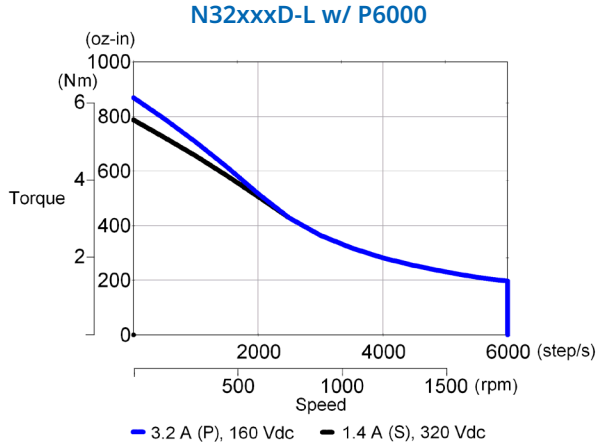

K3/N3 Performance Curves

N33xxLG-L w/ P70360

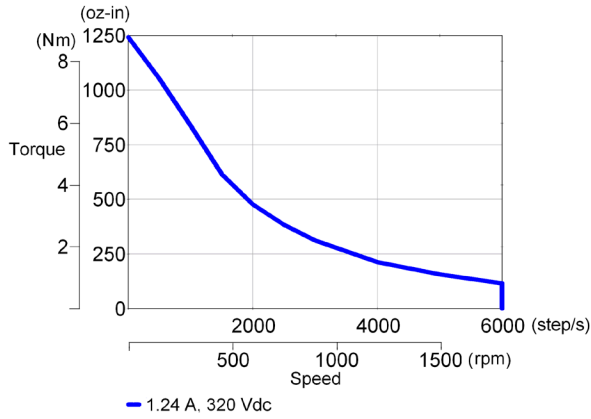

K32xxLG-L w/ P70360

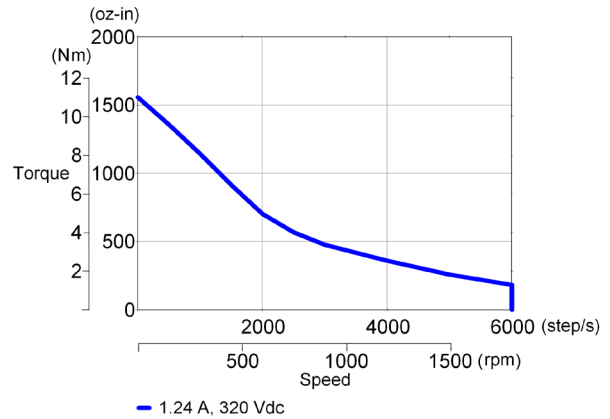

N34xxLG-L w/ P70360

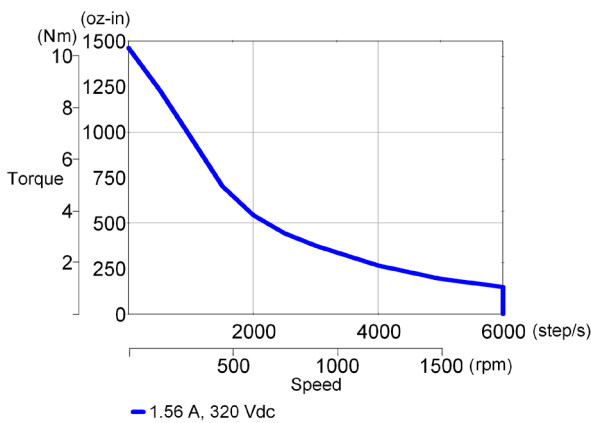

K34xxLG-L w/ P70360

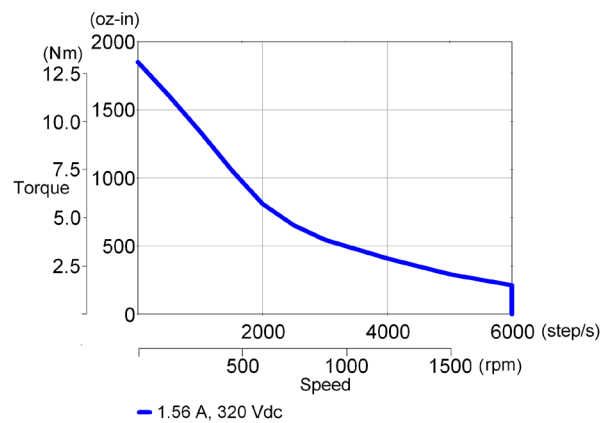

K4 / N4 Series Stepper Motors

K4 / N4 Outline Drawings

Regular Leadwire Hookup

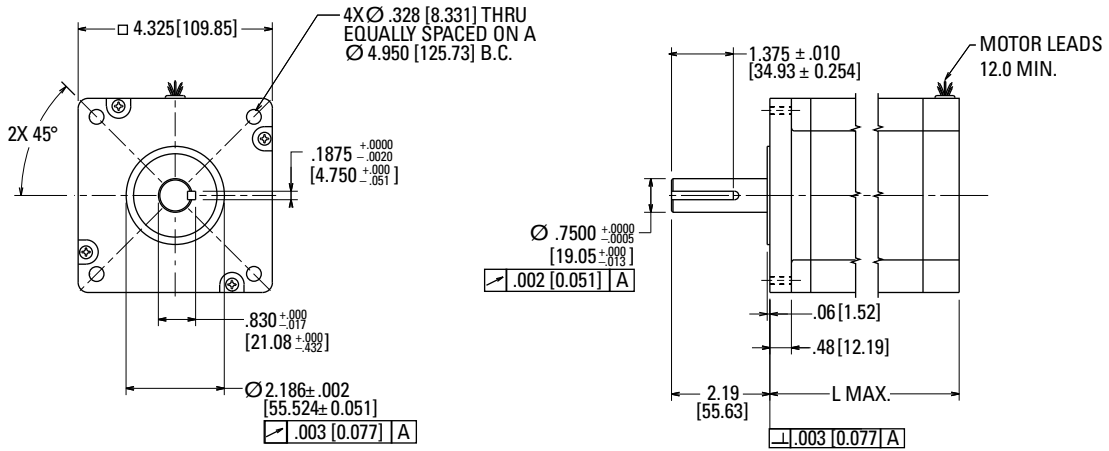

Model	"L" MAX
41HR	3.89 (98.81)
42HR	5.91 (150.11)
43HR	7.92 (201.17)

Dimensions in inches [mm]

Splashproof Construction / Terminal Board Connections

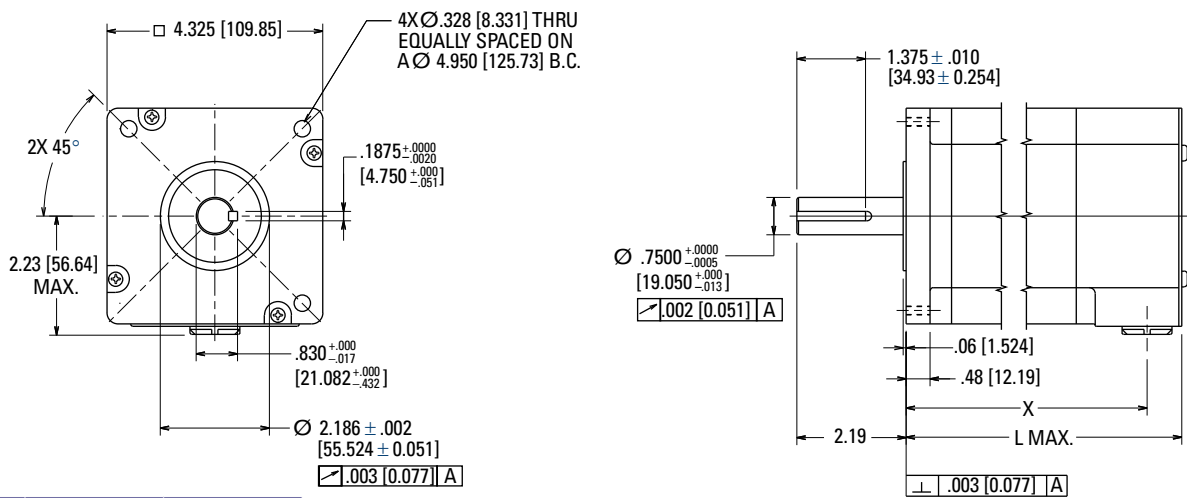

Model	"X"	"L" MAX
41HL	4.46 (113.28)	5.20 (132.08)
42HL	6.48 (164.59)	7.22 (183.39)
43HL	8.49 (215.65)	9.23 (234.44)

Dimensions in inches [mm]

K4 / N4 Outline Drawings

Splashproof Construction / MS Connector(s)

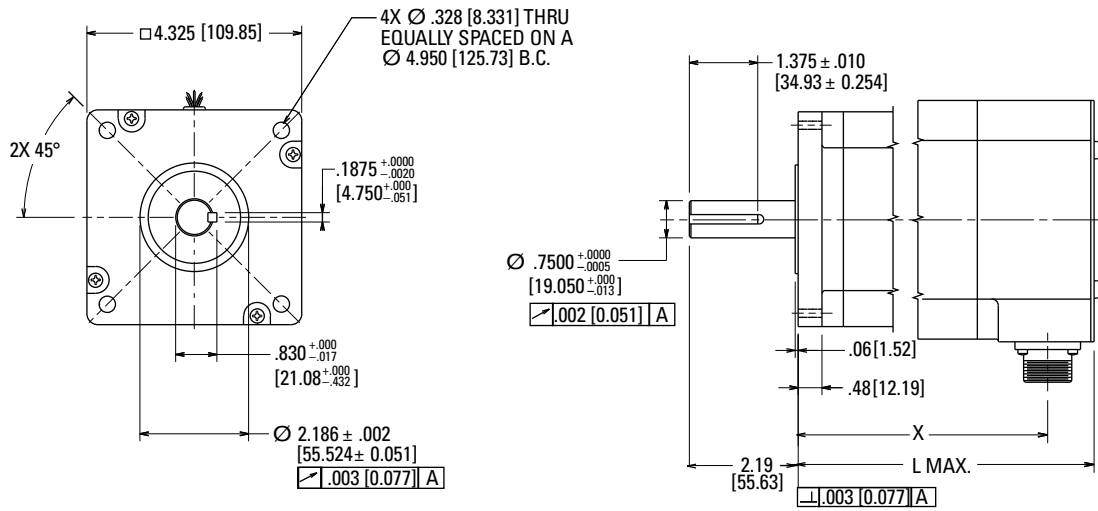

Model	"X"	"L" MAX
41HC	4.32 (109.73)	5.20 (132.08)
42HC	6.33 (160.78)	7.22 (183.39)
43HC	8.35 (212.09)	9.23 (234.44)

Dimensions in inches [mm]

K4 / N4 Series Stepper Motors

K4 / N4 1 Stack Performance Data

Motor Model Number	Config.			Holding Torque (2 phases on) oz-in (Nm) +/-10%	Rated Current/Phase Amps DC	Phase Resistance Ohms +/-10%	Phase Inductance mH Typical	Thermal Resistance Mounted °C/Watt	Rotor Inertia oz-in-s ² (kg-m ² x 10 ⁻³)	Weight lb (kg)	Shaft Loading	
	Parallel	Series	Unipolar								Radial Force lb (N)	Axial Force lb (N)
1 Stack	N41xxHF-L	•		1675 (11.8)	5.2	0.64	12.2	1.9	0.0783 (0.55)	11 (4.98)	125 (556)	404 (1800)
	N41xxLF-L		•		2.6	2.56	48.9					
	N41xxHM-L	•		1655 (11.7)	10.7	0.16	2.8					
	N41xxLM-L		•		5.3	0.63	11.1					
	N41xxHL-L	•		1625 (11.5)	8.7	0.23	3.9					
	N41xxLL-L		•		4.4	0.93	15.8					
	N41xxHJ-L	•		1630 (11.5)	5.5	0.58	10.1					
	N41xxLJ-L		•		2.7	2.33	40.4					
	N41xxHG-L	•		1630 (11.5)	3.5	1.45	25.1					
	N41xxLG-L		•		1.73	5.76	100					
	N41xxEF-L		•	1185 (8.37)	3.7	1.28	12.2					
	N41xxEM-L		•	1170 (8.26)	7.5	0.23	2.8					
	N41xxEL-L		•	1150 (8.12)	6.2	2.33	3.9					
	N41xxEJ-L		•	1150 (8.12)	3.9	1.16	10.1					
N41xxEG-L		•	1150 (8.12)	2.4	2.89	25.1						
Enhanced 1 Stack	K41xxHF-L	•		2170 (15.3)	5.2	0.64	9.5	1.9	0.0783 (0.55)	11 (4.98)	125 (556)	404 (1800)
	K41xxLF-L		•		2.6	2.56	38					
	K41xxHM-L	•		2135 (15.1)	10.7	0.16	2.2					
	K41xxLM-L		•		5.3	0.63	8.7					
	K41xxHL-L	•		2090 (14.8)	8.7	0.23	3.1					
	K41xxLL-L		•		4.4	0.93	12.3					
	K41xxHJ-L	•		2095 (14.8)	5.5	0.58	7.8					
	K41xxLJ-L		•		2.7	2.33	31.4					
	K41xxHG-L	•		2095 (14.8)	3.5	1.45	19.5					
	K41xxLG-L		•		1.73	5.80	77.9					
	K41xxEF-L		•	1535 (10.8)	3.7	1.28	9.5					
	K41xxEM-L		•	1510 (10.7)	7.5	0.31	2.2					
	K41xxEL-L		•	1480 (10.5)	6.2	0.47	3.1					
	K41xxEJ-L		•	1480 (10.5)	3.9	1.16	7.8					
K41xxEG-L		•	1480 (10.5)	2.4	2.89	25.1						

K4 / N4 2 Stack Performance Data

Motor Model Number	Config.			Holding Torque (2 phases on) oz-in (Nm) +/-10%	Rated Current/Phase Amps DC	Phase Resistance Ohms +/-10%	Phase Inductance mH Typical	Thermal Resistance Mounted °C/Watt	Rotor Inertia oz-in-s ² (kg-m ² x 10 ⁻³)	Weight lb (kg)	Shaft Loading	
	Parallel	Series	Unipolar								Radial Force lb (N)	Axial Force lb (N)
2 Stack	N42xxHF-L	•		2925 (20.6)	5.5	0.81	14.4	1.3	0.155 (1.09)	18.4 (8.34)	110 (489)	404 (1800)
	N42xxLF-L		•	2923 (20.6)	2.7	3.2	57.7					
	N42xxHN-L	•		3130 (22.1)	15.8	0.10	2.1					
	N42xxLN-L		•		7.9	0.41	8.4					
	N42xxHM-L	•		3145 (22.2)	9.9	0.25	5.5					
	N42xxLM-L		•		4.9	1.02	22					
	N42xxHL-L	•		3085 (21.8)	8.1	0.38	7.8					
	N42xxLL-L		•		4.0	1.51	31.2					
	N42xxHK-L	•		3105 (21.9)	6.4	0.60	12.8					
	N42xxLK-L		•		3.2	2.41	51.1					
	N42xxHG-L	•		2315 (22.7)	4.8	1.07	25.3					
	N42xxLG-L		•		2.4	4.27	101					
	N42xxEF-L		•	2065 (14.6)	3.9	1.62	14.4					
	N42xxEN-L		•	2215 (15.6)	11.2	0.21	2.1					
	N42xxEM-L		•	2225 (15.7)	7.0	0.51	5.5					
	N42xxEL-L		•	2185 (15.4)	5.7	0.75	7.8					
	N42xxEK-L		•	2200 (15.5)	4.5	1.2	12.8					
	N42xxEG-L		•	2920 (20.6)	3.4	2.14	19.4					
Enhanced 2 Stack	K42xxHF-L	•		3700 (26.1)	5.5	0.81	11.1	1.2	0.155 (1.09)	18.4 (8.34)	110 (489)	404 (1800)
	K42xxLF-L		•		2.7	3.23	44.2					
	K42xxHN-L	•		4000 (28.2)	15.8	0.10	1.6					
	K42xxLN-L		•		7.9	0.41	6.5					
	K42xxHM-L	•		4025 (28.4)	9.9	0.25	4.2					
	K42xxLM-L		•		4.9	1.02	16.9					
	K42xxHL-L	•		3935 (27.8)	8.1	0.38	6.0					
	K42xxLL-L		•		4.0	1.51	23.9					
	K42xxHK-L	•		3965 (28.0)	6.4	0.60	9.8					
	K42xxLK-L		•		3.2	2.41	39.2					
	K42xxHG-L	•		4130 (29.1)	4.8	1.07	19.4					
	K42xxLG-L		•		2.4	4.27	77.5					
	K42xxEF-L		•	2615 (18.5)	3.9	1.62	11.1					
	K42xxEN-L		•	2830 (20.0)	11.2	0.21	1.6					
	K42xxEM-L		•	2845 (20.1)	7.0	0.51	4.2					
	K42xxEL-L		•	2785 (19.7)	5.7	0.75	6.0					
	K42xxEK-L		•	2805 (19.8)	4.5	1.2	9.8					
	K42xxEG-L		•	2920 (20.6)	3.4	2.14	19.4					

K4 / N4 Series Stepper Motors

K4 / N4 3 Stack Performance Data

	Motor Model Number	Config.			Holding Torque (2 phases on) oz-in (Nm) +/-10%	Rated Current/Phase Amps DC	Phase Resistance Ohms +/-10%	Phase Inductance mH Typical	Thermal Resistance Mounted °C/Watt	Rotor Inertia oz-in-s ² (kg-m ² x 10 ⁻³)	Weight lb (kg)	Shaft Loading	
		Parallel	Series	Unipolar								Radial Force lb (N)	Axial Force lb (N)
Enhanced 2 Stack	K42xxHF-L	•			3700 (26.1)	5.5	0.81	11.1	1.2	0.155 (1.09)	18.4 (8.34)	110 (489)	404 (1800)
	K42xxLF-L		•			2.7	3.23	44.2					
	K42xxHN-L	•			4000 (28.2)	15.8	0.10	1.6					
	K42xxLN-L		•			7.9	0.41	6.5					
	K42xxHM-L	•			4025 (28.4)	9.9	0.25	4.2					
	K42xxLM-L		•			4.9	1.02	16.9					
	K42xxHL-L	•			3935 (27.8)	8.1	0.38	6.0					
	K42xxLL-L		•			4.0	1.51	23.9					
	K42xxHK-L	•			3965 (28.0)	6.4	0.60	9.8					
	K42xxLK-L		•			3.2	2.41	39.2					
	K42xxHG-L	•			4130 (29.1)	4.8	1.07	19.4					
	K42xxLG-L		•			2.4	4.27	77.5					
	K42xxEF-L			•	2615 (18.5)	3.9	1.62	11.1					
	K42xxEN-L			•	2830 (20.0)	11.2	0.21	1.6					
	K42xxEM-L			•	2845 (20.1)	7.0	0.51	4.2					
	K42xxEL-L			•	2785 (19.7)	5.7	0.75	6.0					
K42xxEK-L			•	2805 (19.8)	4.5	1.2	9.8						
K42xxEG-L			•	2920 (20.6)	3.4	2.14	19.4						
3 Stack	N43xxHN-L	•			4365 (30.8)	15.4	0.14	3.2	1.0	0.229 (1.62)	25.7 (11.6)	110 (489)	404 (1800)
	N43xxLN-L		•			7.7	0.55	13					
	N43xxHM-L	•			4320 (30.5)	9.9	0.33	7.7					
	N43xxLM-L		•			4.9	1.32	30.7					
	N43xxHL-L	•			4250 (30.0)	8.0	0.50	11					
	N43xxLL-L		•			4.0	1.98	44.2					
	N43xxHK-L	•			4340 (30.6)	6.2	0.82	19.6					
	N43xxLK-L		•			3.1	3.29	78.5					
	N43xxEN-L			•	3090 (21.8)	10.9	0.28	3.2					
	N43xxEM-L			•	3055 (21.6)	7.0	0.66	7.7					
N43xxEL-L			•	3010 (21.2)	5.7	0.99	11						
N43xxEK-L			•	3070 (21.7)	4.4	1.65	19.6						
Enhanced 3 Stack	K43xxHN-L	•			5700 (40.2)	15.4	0.14	2.5	1.0	0.229 (1.62)	25.7 (11.6)	110 (489)	404 (1800)
	K43xxLN-L		•			7.7	0.55	10					
	K43xxHM-L	•			5630 (39.7)	9.9	0.33	5.9					
	K43xxLM-L		•			4.9	1.32	23.7					
	K43xxHL-L	•			5530 (39.0)	8.0	0.50	8.5					
	K43xxLL-L		•			4.0	1.98	34.1					
	K43xxHK-L	•			5655 (39.9)	6.2	0.82	15.2					
	K43xxLK-L		•			3.1	3.29	60.7					
	K43xxEN-L			•	4030 (28.4)	10.9	0.28	2.5					
	K43xxEM-L			•	3985 (28.1)	7.0	0.66	5.9					
	K43xxEL-L			•	3910 (27.6)	5.7	0.99	8.5					
	K43xxEK-L			•	4000 (28.2)	4.4	1.65	15.2					

Notes

- N** - Motor Series
- 4** - Frame Size
- 2** - Stack Length
- H** - Mounting
- R** - Construction
- L** - Lead Connection
- G** - Winding Type
-
- L** - Rotor Type
- N** - Shaft Cfg.
- N** - Shaft Mod.
- NS** - Encoder Opt.
-
- 00** - Customization

0.125 inch divisions

K4 / N4 Series Stepper Motors

K4/N4 Performance Curves

N41xxHJ-L w/ P70530

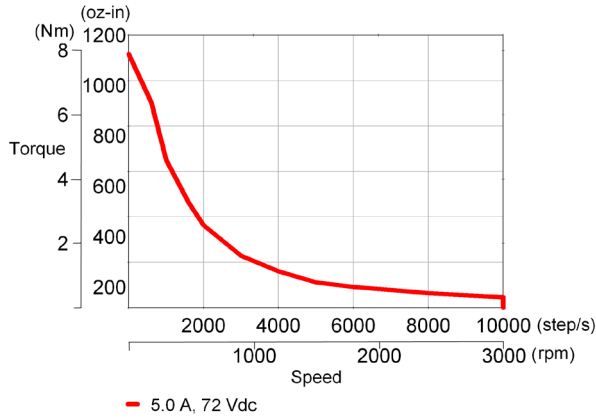

K41xxHJ-L w/ P70530

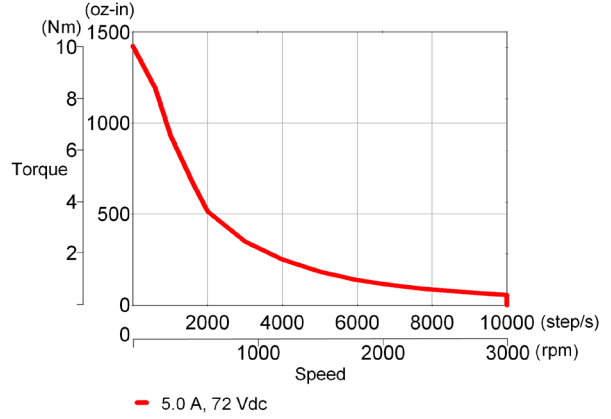

N41xxxF-L w/ P6000

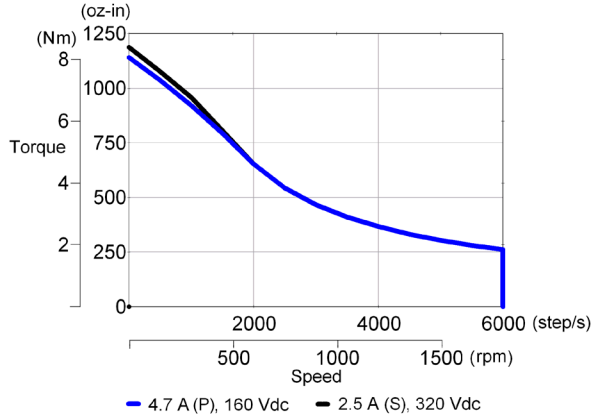

K41xxxF-L w/ P6000

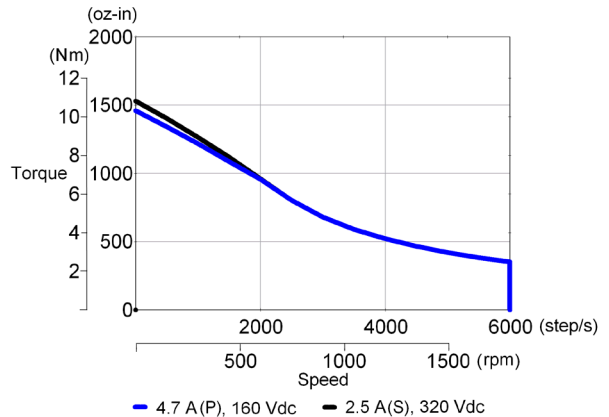

N41xxLG-L w/ P70360

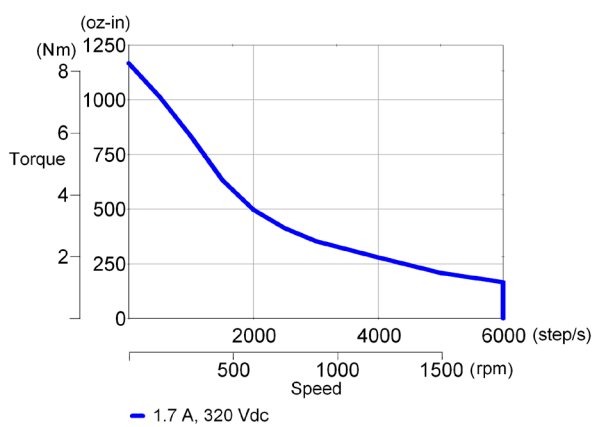

K41xxLG-L w/ P70360

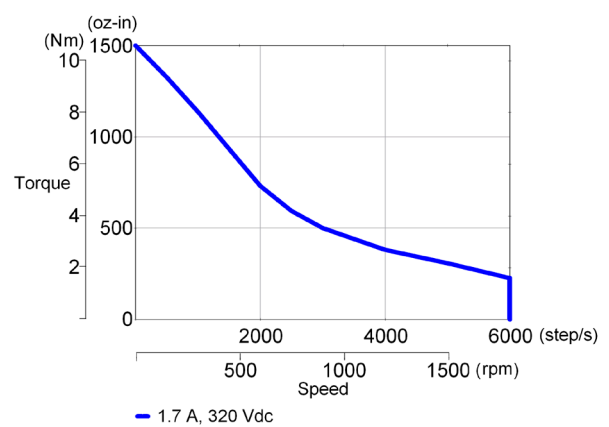

K4/N4 Performance Curves

N42xxF-L w/ P6000

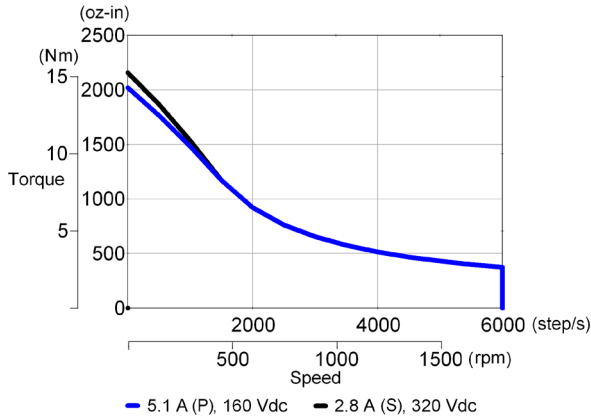

K42xxxF-L w/ P6000

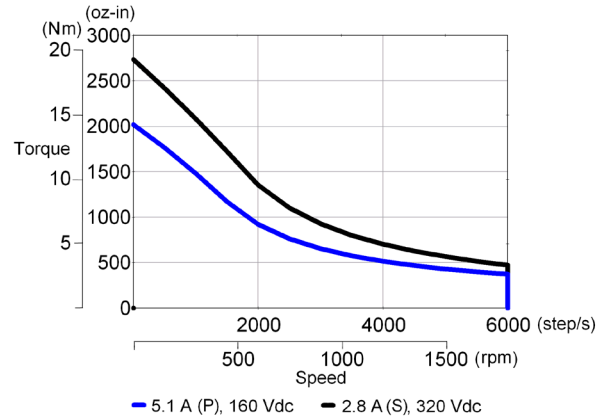

N42xxLG-L w/ P70360

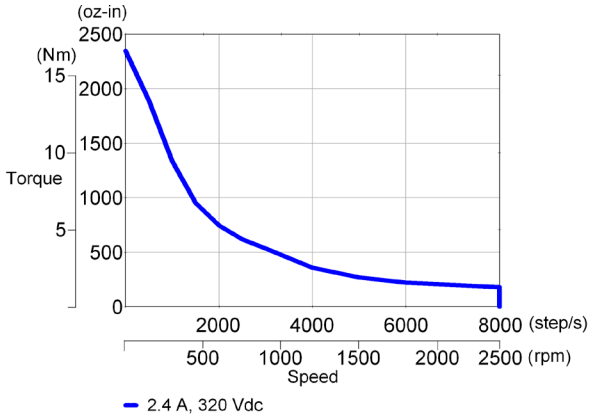

K42xxLG-L w/ P70360

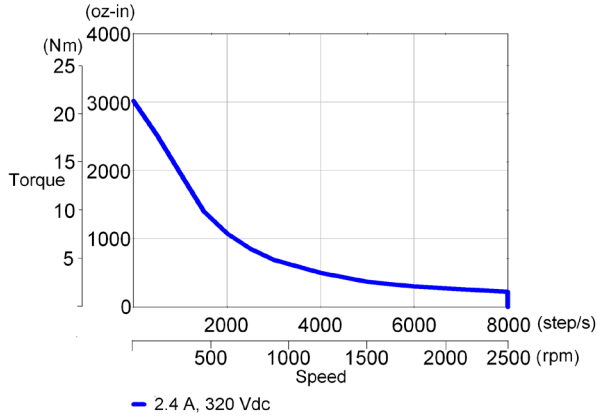

POWERPAC® K/N Series Stepper Motors

K/N Encoder Options

Encoder Specifications

Parameter	Code	
	PD	PF
Type	Optical Incremental	
Supply Voltage	5 Vdc ±10%	
Lines per Revolution	500	1000
Output Format	Dual Channel Quadrature with Index (Z)	
Output Type	Differential Line Drive (with compliments)	
Output Frequency (kHz)	100	
Operating Temperature (°C)	-40 to 100	
Storage Temperature (°C)	-40 to 100	

PD Encoder Dimensional Drawings

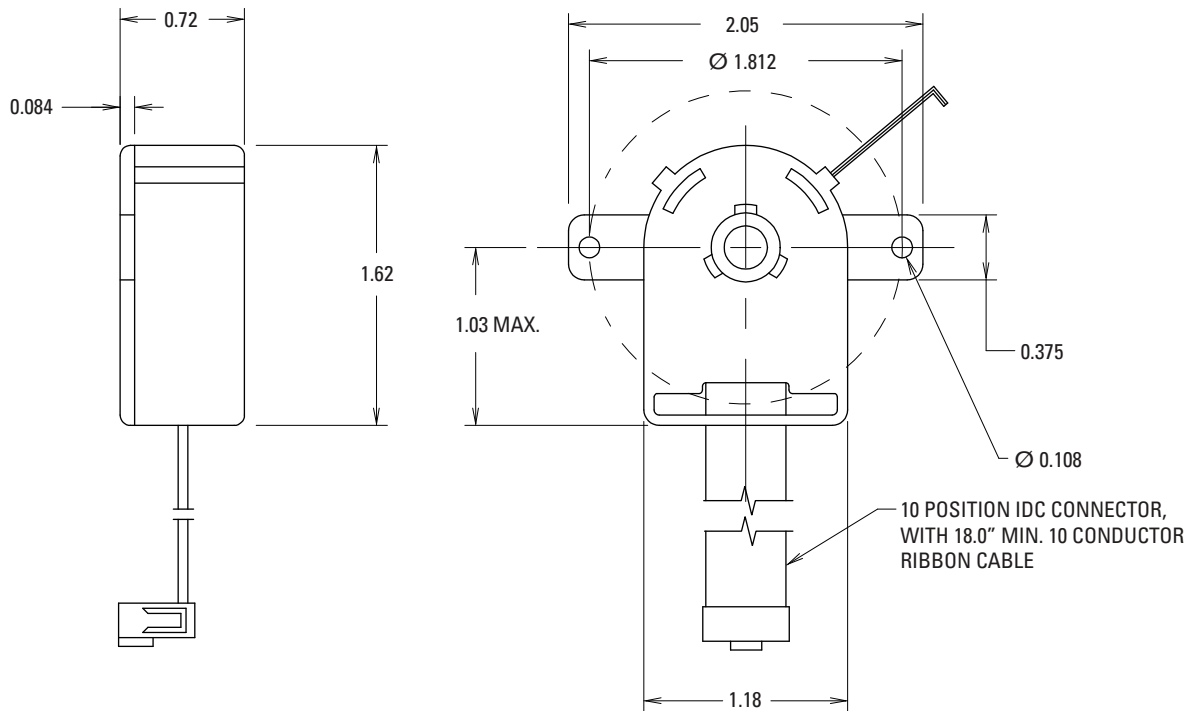

PF Encoder Dimensional Drawings

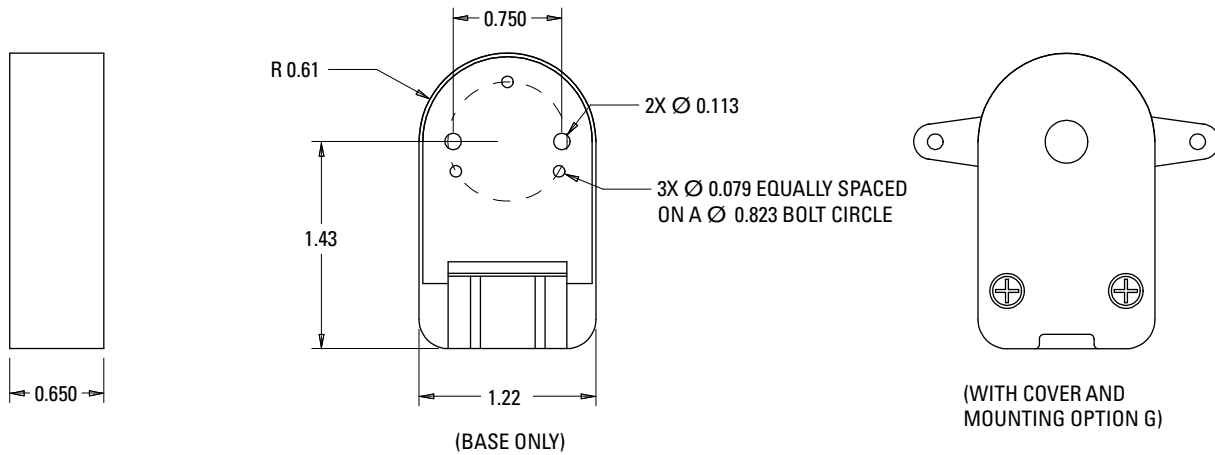

PD, PF Encoder Connection

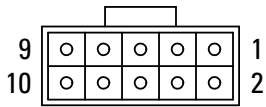

10 -PIN Connector	Color	Function	MS Connector
1	Brown	N/C	-
2	Red	+5 V	G
3	Orange	GROUND	H
4	Yellow	N/C	-
5	Green	\bar{A}	A
6	Blue	A	B
7	Violet	\bar{B}	C
8	Gray	B	D
9	White	Z (Index)	E
10	Black	\bar{Z} (Index)	F

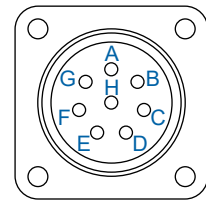

**MS Connector
MS3102E20-7P**

Mating Plug Type
MS3106F20-7S

PD, PF Encoder Phase Diagram

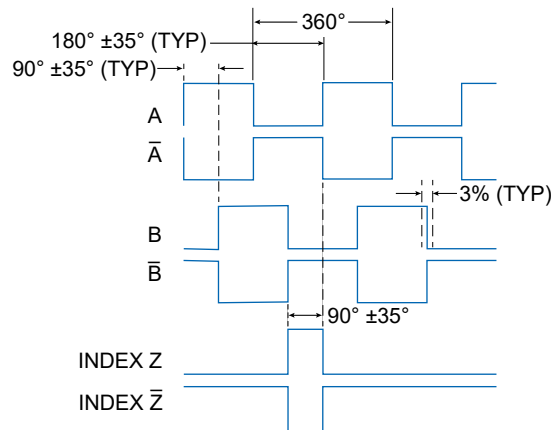

OUTPUT FORMAT FOR CCW ROTATION VIEWED FROM ENCODER END

E/H Series Stepper Motors

These high-efficiency, low-loss stepper motors have a conventional, round frame in NEMA 34 and 42 frame sizes (90 and 110 mm). A wide variety of standard windings, connectors and options suit general-purpose applications with holding torques up to 27.95 N-m (3,958 oz-in). The E Series features SIGMAX™ technology for higher torque and acceleration rates.

Features

- » Conventional round frame design available in NEMA 34 and NEMA 41
- » Holding torques up to 27.95 N-m (3,958 oz-in)
- » Highly customizable to fit nearly any application
- » Both E and H Series motors provide the high speed capability required for rapid traverse applications
- » E Series general-purpose motors feature our SIGMAX™ technology for higher torque and acceleration rates
- » Select from terminal board connections (via conduit), MS connectors or flying lead connections in waterproof or standard enclosures
- » NEMA 34 and 42 models are UL Recognized and feature Class B insulation
- » NEMA 34 and 42 models are rated for IP65 with "C" (MS Connector), "L" (Terminal Board) or "M" (Terminal Board) construction, with shaft seal



General Specifications

- » NEMA Sizes 34 and 42
- » Excellent for applications requiring high torque over a wide speed range
- » Standard "H" and enhanced "E" SIGMAX designs
- » UL, CE Compliant
- » Unipolar or Bipolar windings
- » Standard Features: Shaft Flats or Keyways, Rear Shaft, Flying Leads or Motor-Mounted Connectors, Encoder Mounting Provisions, Incremental Encoders, Shaft Seals, Full IP65 Options
- » Co-Engineered Options: Shaft Modifications, Special Windings, Lead Lengths, Connectors

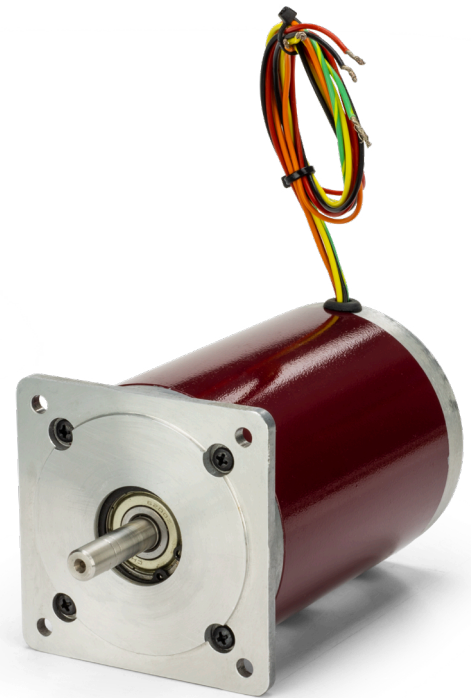

Parameter	E3/H3	E4/H4
NEMA frame size	34	42
Phases	Unipolar and Bipolar	
Full Steps per Revolution	200	
Step Angle (degrees)	1.8	
Step Accuracy % (of one full step, no load)	+/- 1.5 % E Series +/- 3.0 % H Series	
Operating Temperature	-20°C to +40°C	
Insulation Class	Class B, 130°C	
Insulation Voltage Rating	340 Vdc	
Insulation Resistance	100 Megohms	

E / H Series Stepper Motors

E/H Series Stepper Motor F (8 Lead) Connection Information

"F" 8-Lead Configuration

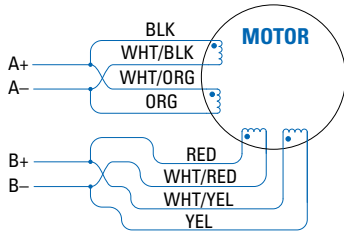

4-Lead Bipolar Connection Parallel

Driver Connection	Lead Color	Terminal Number	MS Connector Pinout
A	Black & Wht/Org	1 & 5	A & F
\bar{A}	Org & Wht/Blk	3 & 6	B & E
B	Red & Wht/Yel	2 & 7	C & H
\bar{B}	Yel & Wht/Red	4 & 8	D & G

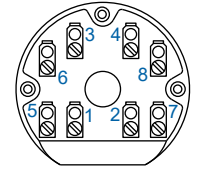

Terminal Board

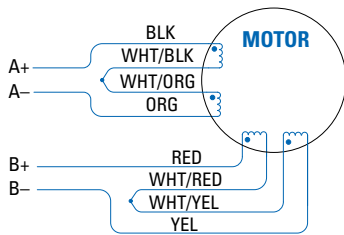

4-Lead Bipolar Connection Series

Driver Connection	Lead Color	Terminal Number	MS Connector Pinout
A	Black (Blk)	1	A
\bar{A}	Orange (Org)	3	B
B	Red	2	C
\bar{B}	Yellow (Yel)	4	D
None	Wht/Blk & Wht/Org	5 & 6	E & F
None	Wht/Red & Wht/Yel	7 & 8	G & H

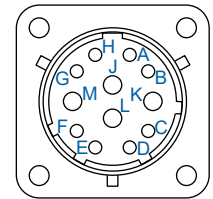

MS Connector
MS3122E14-12P

Mating Plug Type
MS3116F14-12S

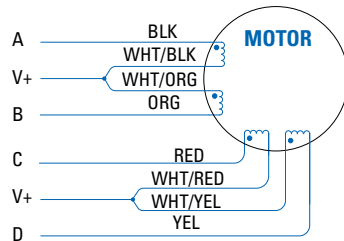

6-Lead Unipolar Connection

Driver Connection	Lead Color	Terminal Number	MS Connector Pinout
A	Black (Blk)	1	A
B	Orange (Org)	3	B
C	Red	2	C
D	Yellow (Yel)	4	D
V+	Wht/Blk & Wht/Org	5 & 6	E & F
V+	Wht/Red & Wht/Yel	7 & 8	G & H

Bipolar Full Step Phase Sequence

STEP	A	\bar{A}	B	\bar{B}
1	+	-	-	+
2	-	+	-	+
3	-	+	+	-
4	+	-	+	-
1	+	-	-	+

CCW ↓ ↑ CW

Unipolar Full Step Phase Sequence

STEP	A	B	C	D
1	GND	0	GND	0
2	0	GND	GND	0
3	0	GND	0	GND
4	GND	0	0	GND
1	GND	0	GND	0

CCW ↓ ↑ CW

E/H Series Stepper Motor E (6 Lead) and H, L (4 Lead) Connection Information

"E" 6-Lead Configuration

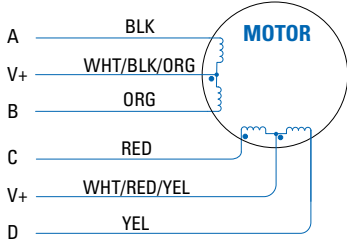

6-Lead Unipolar Connection

Driver Connection	Lead Color	Terminal Number	MS Connector Pinout
A	Black (Blk)	1	A
B	Orange (Org)	3	B
C	Red	2	C
D	Yellow (Yel)	4	D
V+	Wht/Blk/Org	5	J
V+	Wht/Red/Yel	6	L

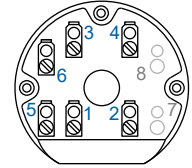

Terminal Board

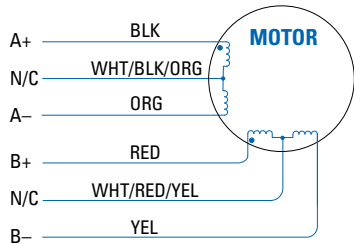

4-Lead Bipolar Series Connection

Driver Connection	Lead Color	Terminal Number	MS Connector Pinout
A	Black	1	A
\bar{A}	Orange	3	B
B	Red	2	C
\bar{B}	Yellow	4	D
N/C	Wht/Blk/Org	5	J
N/C	Wht/Red/Yel	6	L
Ground	Green/Yellow	n/a	n/a

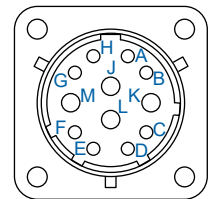

MS Connector MS3122E14-12P

Mating Plug Type MS3116F14-12S

"H" "L" 4-Lead Configuration

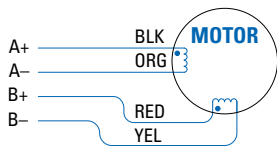

4-Lead Bipolar Connection

Driver Connection	Lead Color	Terminal Number	MS Connector Pinout
A	Black	1	A
\bar{A}	Orange	3	B
B	Red	2	C
\bar{B}	Yellow	4	D
Ground	Green/Yellow	n/a	E

Terminal Board

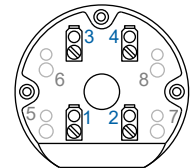

MS Connector MS3122E14-5P

Mating Plug Type MS3116F14-5S

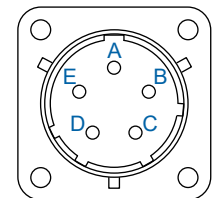

Unipolar Full Step Phase Sequence

STEP	A	B	C	D
1	GND	0	GND	0
2	0	GND	GND	0
3	0	GND	0	GND
4	GND	0	0	GND
1	GND	0	GND	0

CCW ↓ ↑ CW

Bipolar Full Step Phase Sequence

STEP	A	\bar{A}	B	\bar{B}
1	+	-	-	+
2	-	+	-	+
3	-	+	+	-
4	+	-	+	-
1	+	-	-	+

CCW ↓ ↑ CW

E / H Series Stepper Motors

E/H Series Stepper Motor Nomenclature

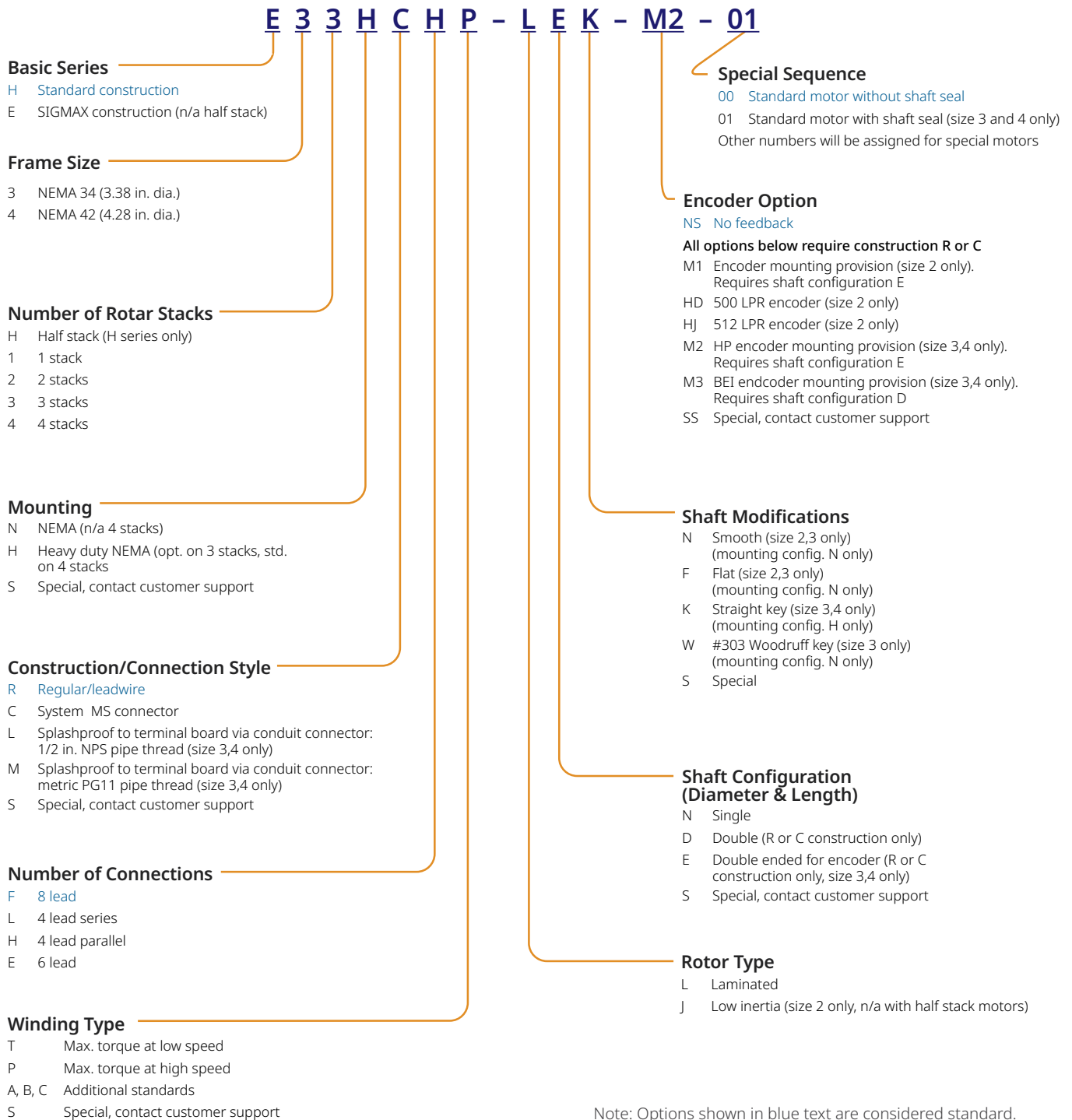

E3 / H3 Outline Drawings

Leadwire Construction, Standard NEMA Front End Bell

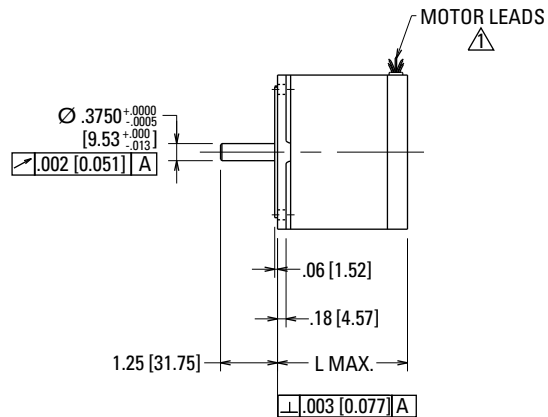
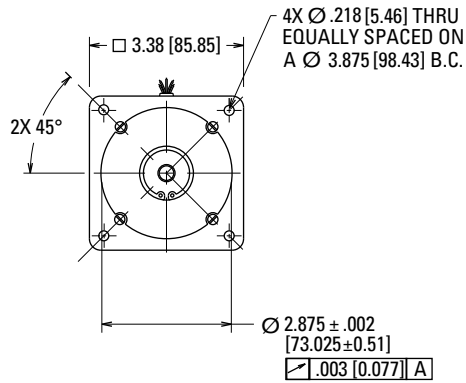

Model	L Max.
31NR	2.58 [65.5]
32NR	3.76 [95.5]
33NR	5.06 [128.5]

Δ 12.0 [304.8] MINIMUM
 4 Lead Motors: #18 AWG
 6 & 8 Lead Motors: #22 AWG.

Dimensions in inches [mm]

Leadwire Construction, Heavy Duty Front End Bell

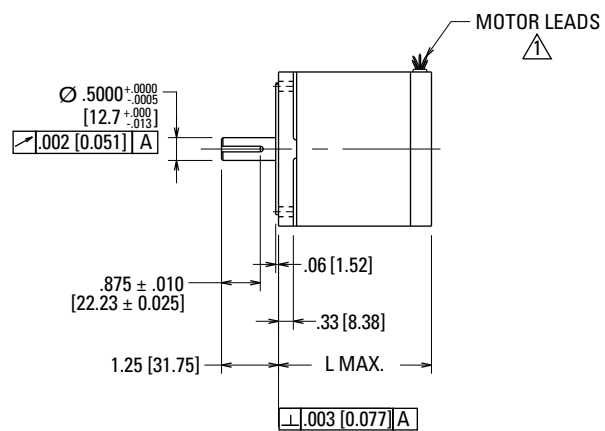
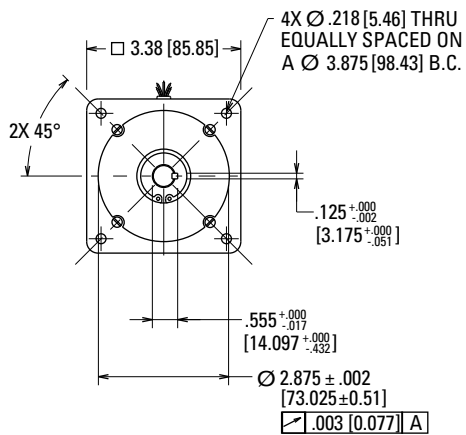

Model	Max.
33HR	5.33 [135.4]
34HR	6.58 [162.1]

Δ 12.0 [304.8] MINIMUM
 4 Lead Motors: #18 AWG
 6 & 8 Lead Motors: #22 AWG.

Dimensions in inches [mm]

E / H Series Stepper Motors

E3 / H3 Outline Drawings

Shaft Configurations

Standard Front Shaft Configurations

Note: Not available with heavy duty models

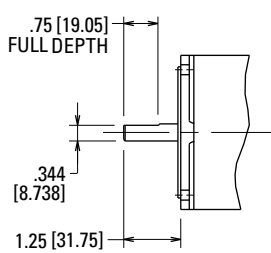

Flat, Configuration = F

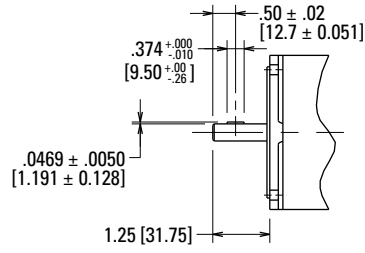

#303 Woodruff Key, Configuration = W

Standard Double Shaft Configuration

Note: Not available with splashproof models

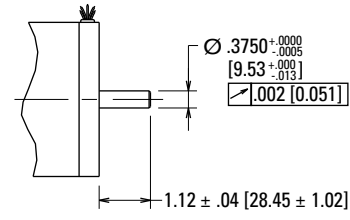

Rear Shaft, Configuration = D

Dimensions in inches [mm]

Splashdown Construction, Standard NEMA Front End Bell

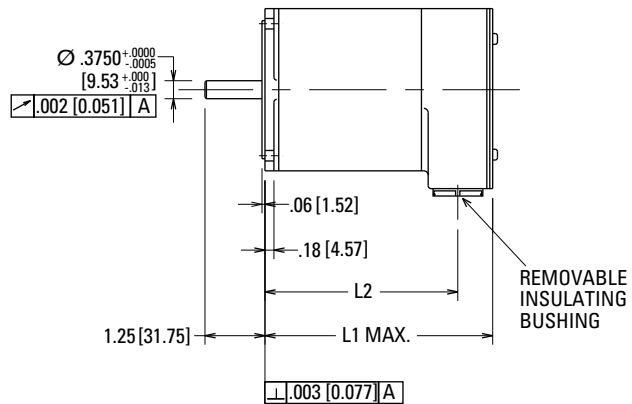
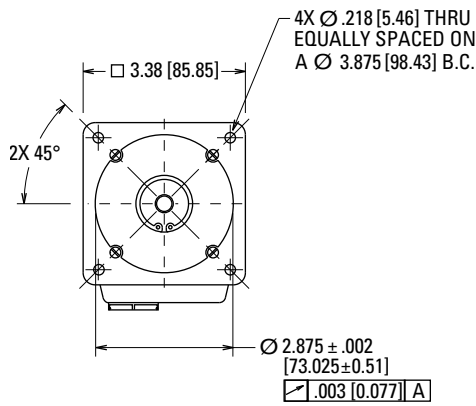

Model	L1 Max.	L2
31N[L or M]	3.62 [91.95]	2.87 [72.9]
32N[L or M]	4.77 [121.2]	4.02 [102.11]
33N[L or M]	6.05 [153.7]	5.30 [134.62]

Dimensions in inches [mm]

E3 / H3 Outline Drawings

Splashdown Construction, Heavy Duty NEMA Front End Bell

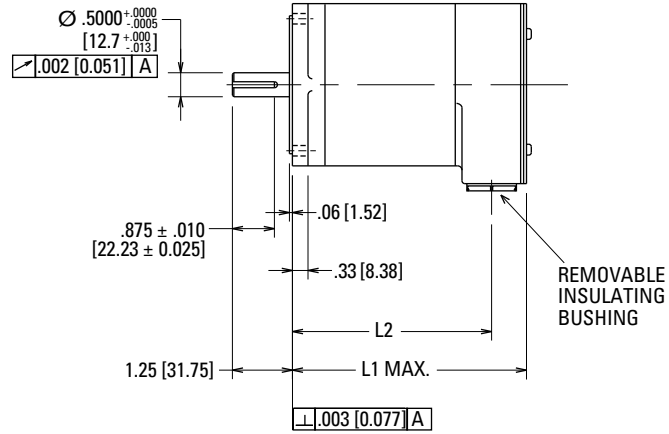
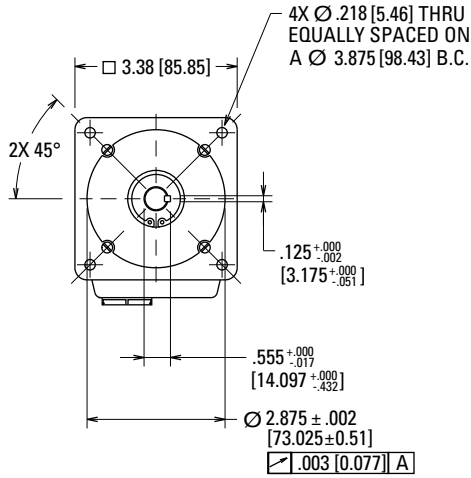

Model	L1 Max.	L2
33H[L or M]	6.73 [170.94]	5.61 [142.49]
34H[L or M]	7.62 [193.6]	6.86 [174.24]

Dimensions in inches [mm]

MS Connector, Encoder Option, Standard NEMA Front End Bell

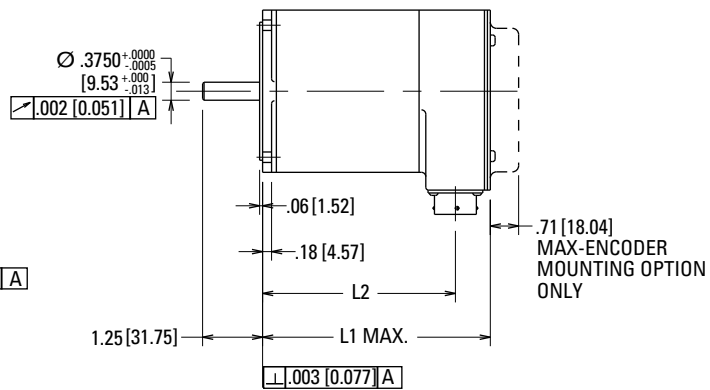
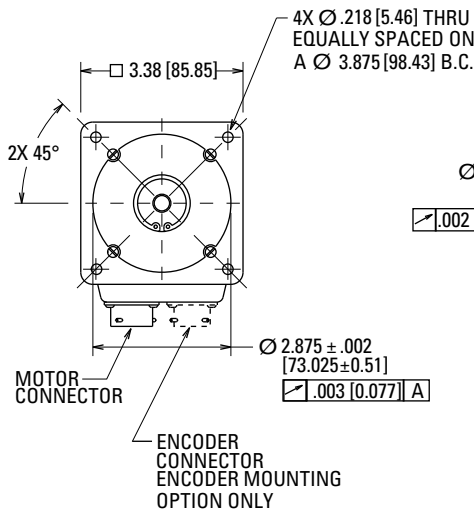

Model	L1 Max.	L2
31NC	3.62 [91.95]	2.87 [72.9]
32NC	4.77 [121.2]	4.02 [102.11]
33NC	6.05 [153.7]	5.30 [134.62]

Dimensions in inches [mm]

E / H Series Stepper Motors

E3 / H3 Outline Drawings

MS Connector, Encoder Option, Heavy Duty Front End Bell

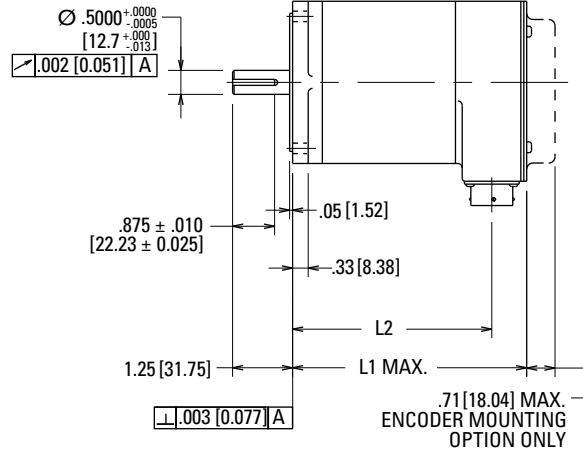
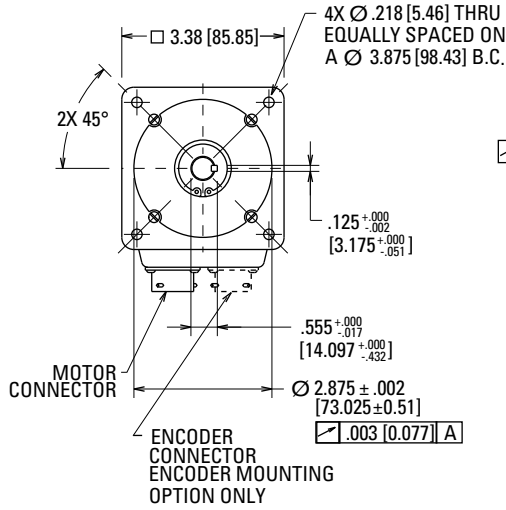

Model	L1 Max.	L2
33HC	6.73 [170.94]	5.61 [142.49]
34HC	7.62 [193.6]	6.86 [174.24]

Dimensions in inches [mm]

E4 / H4 Outline Drawings

Splashproof Construction, Terminal Board

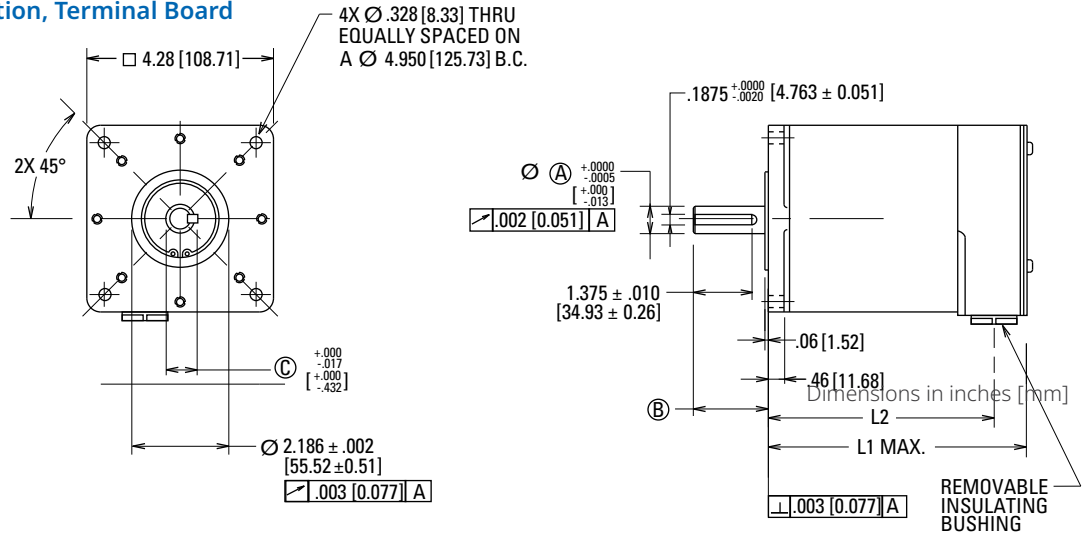

MS Connector, Encoder Option

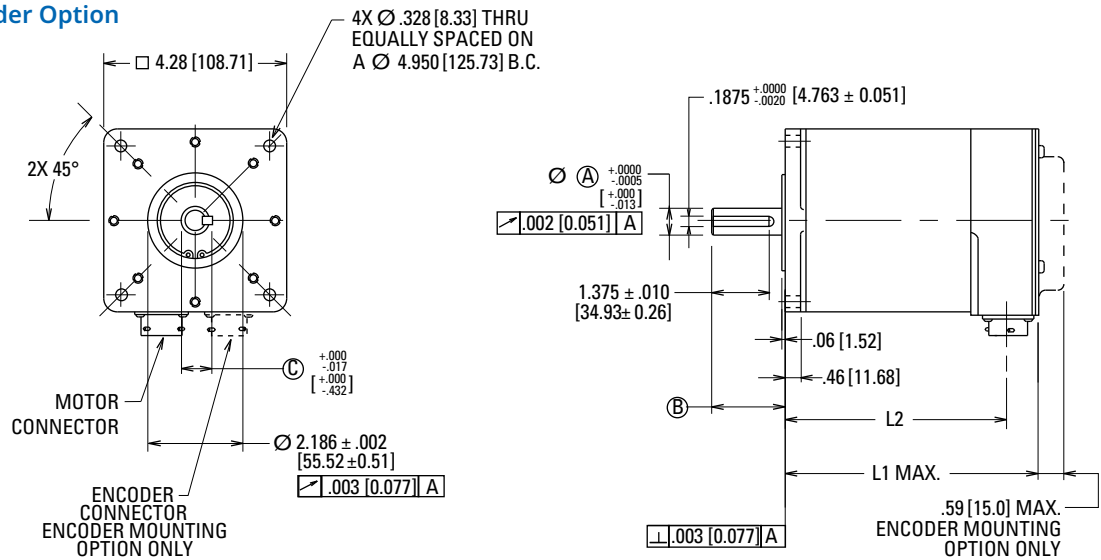

Model	L1 Max.	L2
41H[C.L. or M]	5.61 [142.5]	4.85 [123.19]
42H[C.L. or M]	8.04 [204.22]	7.29 [185.17]
43H[C.L. or M]	10.56 [268.23]	9.81 [249.18]

Model	A	B	C
41H[C.L. or M]	0.6250 [15.875]	1.75 [17.91]	0.705 [17.91]
42H[C.L. or M]	0.6250 [15.875]	2.19 [55.63]	0.705 [17.91]
43H[C.L. or M]	0.7500 [19.05]	2.19 [55.63]	0.830 [21.09]

Standard Round Mounting Configuration

Note: Not available on 3 stack motor

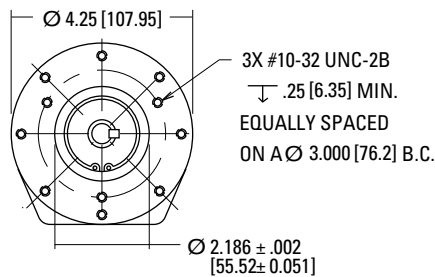

E / H Series Stepper Motors

E3 / H3 1-Stack Performance Data

	Motor Model Number	Config.			Holding Torque (2 phases on) oz-in (Nm) +/-10%	Rated Current/ Phase Amps DC	Phase Resistance Ohms +/-10%	Phase Inductance mH Typical	Thermal Resistance Mounted °C/Watt	Rotor Inertia oz-in-s ² (kg-m ² x 10 ⁻³)	Weight lb (kg)	Shaft Loading	
		Parallel	Series	Unipolar								Radial Force lb (N)	Axial Force lb (N)
1 Stack	H31xxHP-L	•			239 (1.69)	8.4	0.13	1.0	3.9	0.0083 (0.0586)	3.2 (1.45)	35 (156)	180 (801)
	H31xxLP-L		•			4.2	0.52	4.0					
	H31xxHA-L	•			242 (1.71)	8.2	0.14	1.1					
	H31xxLA-L		•			4.1	0.50	4.5					
	H31xxHB-L	•			224 (1.58)	5.9	0.24	1.6					
	H31xxLB-L		•			3.0	0.94	6.4					
	H31xxHT-L	•			236 (1.67)	5.4	0.29	2.3					
	H31xxLT-L		•			2.7	1.12	9.3					
	H31xxHC-L	•			224 (1.58)	3.0	0.94	6.4					
	H31xxLC-L		•			1.48	3.73	25.8					
	H31xxEP-L			•	169 (1.19)	5.9	0.27	1.0					
	H31xxEA-L			•	171 (1.21)	5.8	0.28	1.1					
	H31xxEB-L			•	158 (1.12)	4.2	0.50	1.6					
	H31xxET-L			•	167 (1.18)	3.8	0.59	2.3					
	H31xxEC-L			•	158 (1.12)	2.1	1.89	6.4					
1 Stack Enhanced	E31xxHP-L	•			344 (2.43)	8.4	0.13	1.1	3.9	0.0083 (0.0586)	3.2 (1.45)	35 (156)	180 (801)
	E31xxLP-L		•			4.2	0.52	4.4					
	E31xxHA-L	•			349 (2.46)	8.2	0.14	1.2					
	E31xxLA-L		•			4.1	0.55	4.9					
	E31xxHB-L	•			316 (2.23)	5.9	0.24	1.7					
	E31xxLB-L		•			3.0	0.94	6.9					
	E31xxHT-L	•			337 (2.38)	5.4	0.29	2.5					
	E31xxLT-L		•			2.7	1.12	10					
	E31xxHC-L	•			316 (2.23)	3.0	0.94	6.9					
	E31xxLC-L		•			1.48	3.73	27.6					
	E31xxEP-L			•	243 (1.72)	5.9	0.27	1.1					
	E31xxEA-L			•	247 (1.74)	5.8	0.28	1.2					
	E31xxEB-L			•	224 (1.58)	4.2	0.5	1.7					
	E31xxET-L			•	238 (1.68)	3.8	0.59	2.5					
	E31xxEC-L			•	223 (1.57)	2.1	1.89	6.9					

E3 / H3 2-Stack Performance Data

	Motor Model Number	Config.			Holding Torque (2 phases on) oz-in (Nm) +/-10%	Rated Current/Phase Amps DC	Phase Resistance Ohms +/-10%	Phase Inductance mH Typical	Thermal Resistance Mounted °C/Watt	Rotor Inertia oz-in-s ² (kg-m ² x 10 ⁻³)	Weight lb (kg)	Shaft Loading	
		Parallel	Series	Unipolar								Radial Force lb (N)	Axial Force lb (N)
2 Stack	H32xxHP-L	•			471 (3.33)	8.1	0.19	2.4	2.7	0.017 (0.120)	5.3 (2.40)	35 (156)	180 (801)
	H32xxLP-L		•			4.1	0.74	9.6					
	H32xxHA-L	•			445 (3.14)	5.6	0.39	4.1					
	H32xxLA-L		•			2.8	1.51	16.2					
	H32xxHT-L	•			463 (3.27)	5.2	0.44	5.4					
	H32xxLT-L		•			2.6	1.74	21.6					
	H32xxEP-L			•	333 (2.35)	5.7	0.39	2.4					
	H32xxEA-L			•	314 (2.22)	4.0	0.78	4.1					
	H32xxET-L			•	328 (2.32)	3.7	0.89	5.4					
2 Stack Enhanced	E32xxHP-L	•			673 (4.75)	8.1	0.19	2.2	2.7	0.0170 (0.120)	5.3 (2.40)	35 (156)	180 (801)
	E32xxLP-L		•			4.1	0.74	8.9					
	E32xxHA-L	•			627 (4.43)	5.6	0.39	3.7					
	E32xxLA-L		•			2.8	1.51	15					
	E32xxHT-L	•			659 (4.65)	5.2	0.44	5.0					
	E32xxLT-L		•			2.6	1.74	19.9					
	E32xxEP-L			•	476 (3.36)	5.7	0.39	2.2					
	E32xxEA-L			•	443 (3.13)	4.0	0.78	3.7					
	E32xxET-L			•	466 (3.29)	3.7	0.89	5.0					

E / H Series Stepper Motors

E3 / H3 3-Stack Performance Data

Motor Model Number	Config.			Holding Torque (2 phases on) oz-in (Nm) +/-10%	Rated Current/Phase Amps DC	Phase Resistance Ohms +/-10%	Phase Inductance mH Typical	Thermal Resistance Mounted °C/Watt	Rotor Inertia oz-in-s ² (kg-m ² x 10 ⁻³)	Weight lb (kg)	Shaft Loading	
	Parallel	Series	Unipolar								Radial Force lb (N)	Axial Force lb (N)
3 Stack	H33xxHC-L	•		659 (4.65)	11.1	0.15	1.6	2.0	0.025 (0.177)	7.6 (3.45)	35 (156)	180 (801)
	H33xxLC-L		•		5.5	0.59	6.3					
	H33xxHA-L	•		666 (4.70)	8.6	0.23	2.7					
	H33xxLA-L		•		4.3	0.87	10.8					
	H33xxHB-L	•		666 (4.70)	5.4	0.55	6.8					
	H33xxLB-L		•		2.7	2.17	27.2					
	H33xxHT-L	•		687 (4.85)	5.1	0.61	8.4					
	H33xxLT-L		•		2.6	2.41	33.6					
	H33xxHP-L	•		698 (4.93)	7.9	0.26	3.7					
	H33xxLP-L		•		4.0	1.02	14.9					
	H33xxEC-L		•	466 (3.29)	7.8	0.29	1.6					
	H33xxEA-L		•	471 (3.33)	6.1	0.46	2.7					
	H33xxEB-L		•	471 (3.33)	3.8	1.11	6.8					
	H33xxET-L		•	486 (3.43)	3.6	1.23	8.4					
H33xxEP-L		•	494 (3.49)	5.6	0.54	3.7						
3 Stack Enhanced	E33xxHC-L	•		927 (6.55)	11.1	0.15	1.3	2.0	0.025 (0.177)	7.6 (3.45)	35 (156)	180 (801)
	E33xxLC-L		•		5.5	0.59	5.3					
	E33xxHA-L	•		940 (6.64)	8.6	0.23	2.3					
	E33xxLA-L		•		4.3	0.87	9.1					
	E33xxHP-L	•		995 (7.03)	7.9	0.26	3.1					
	E33xxLP-L		•		4.0	1.02	12.6					
	E33xxHB-L	•		939 (6.63)	5.4	0.55	5.7					
	E33xxLB-L		•		2.7	2.17	22.9					
	E33xxHT-L	•		975 (6.89)	5.1	0.61	7.1					
	E33xxLT-L		•		2.6	2.41	28.2					
	E33xxEC-L		•	656 (4.63)	7.8	0.29	1.3					
	E33xxEA-L		•	664 (4.69)	6.1	0.46	2.3					
	E33xxEP-L		•	703 (4.96)	5.6	0.54	3.1					
	E33xxEB-L		•	664 (4.69)	3.8	1.11	5.7					
E33xxET-L		•	689 (4.87)	3.6	1.23	7.1						

E3 / H3 4-Stack Performance Data

	Motor Model Number	Config.			Holding Torque (2 phases on) oz-in (Nm) +/-10%	Rated Current/Phase Amps DC	Phase Resistance Ohms +/-10%	Phase Inductance mH Typical	Thermal Resistance Mounted °C/Watt	Rotor Inertia oz-in-s ² (kg-m ² x 10 ⁻³)	Weight lb (kg)	Shaft Loading	
		Parallel	Series	Unipolar								Radial Force lb (N)	Axial Force lb (N)
4 Stack	H34xxHA-L	•			888 (6.27)	8.1	0.29	3.8	1.7	0.035 (0.247)	9.7 (4.40)	35 (156)	180 (801)
	H34xxLA-L		•			4.1	1.14	15.1					
	H34xxHP-L	•			916 (6.47)	7.7	0.33	4.7					
	H34xxLP-L		•			3.9	1.27	18.6					
	H34xxHT-L	•			882 (6.23)	5.2	0.71	9.1					
	H34xxLT-L		•			2.6	2.8	36.5					
	H34xxEA-L			•	628 (4.43)	5.7	0.60	3.8					
	H34xxEP-L			•	648 (4.58)	5.5	0.66	4.7					
	H34xxET-L			•	624 (4.41)	3.7	1.43	9.1					
4 Stack Enhanced	E34xxHA-L	•			1250 (8.83)	8.1	0.29	3.6	1.7	0.035 (0.247)	9.7 (4.40)	96 (427)	180 (801)
	E34xxLA-L		•			4.1	1.14	13.7					
	E34xxHP-L	•			1300 (9.18)	7.7	0.33	4.4					
	E34xxLP-L		•			3.9	1.27	17.8					
	E34xxHT-L	•			1240 (8.76)	5.2	0.71	8.7					
	E34xxLT-L		•			2.6	2.8	34.8					
	E34xxEA-L			•	886 (6.26)	5.7	0.60	3.6					
	E34xxEP-L			•	920 (6.50)	5.5	0.66	4.4					
	E34xxET-L			•	879 (6.21)	3.7	1.43	8.7					

E / H Series Stepper Motors

E4 / H4 Performance Data

	Motor Model Number	Config.			Holding Torque (2 phases on) oz-in (Nm) +/-10%	Rated Current/Phase Amps DC	Phase Resistance Ohms +/-10%	Phase Inductance mH Typical	Thermal Resistance Mounted °C/Watt	Rotor Inertia oz-in-s ² (kg-m ² x 10 ⁻³)	Weight lb (kg)	Shaft Loading	
		Parallel	Series	Unipolar								Radial Force lb (N)	Axial Force lb (N)
1 Stack	H41xxHA-L ¹	•			839 (5.92)	10.6	0.16	3.1	1.8	0.080 (0.565)	10.9 (4.94)	140 (623)	400 (1780)
	H41xxLA-L ¹		•			5.3	0.64	12.4					
	H41xxHT-L ¹	•			828 (5.84)	5.4	0.61	11.2					
	H41xxLT-L ¹		•			2.7	2.41	44.6					
	H41xxHB-L ¹	•			839 (5.92)	5.3	0.64	12.4					
	H41xxLB-L ¹		•			2.7	2.54	49.4					
	H41xxEA-L ¹			•	593 (4.19)	7.5	0.32	3.1					
	H41xxET-L ¹			•	585 (4.13)	3.8	1.21	11.2					
	H41xxEB-L ¹			•	593 (4.19)	3.7	1.27	12.4					
1 Stack Enhanced	E41xxHA-L ¹	•			1380 (9.74)	10.6	0.16	2.5	1.8	0.080 (0.565)	10.9 (4.94)	140 (623)	400 (1780)
	E41xxLA-L ¹		•			5.3	0.64	10					
	E41xxHT-L ¹	•			1350 (9.53)	5.4	0.61	9.0					
	E41xxLT-L ¹		•			2.7	2.41	36.1					
	E41xxHB-L ¹	•			1380 (9.74)	5.3	0.64	10					
	E41xxLB-L ¹		•			2.7	2.54	40					
	E41xxEA-L ¹			•	974 (6.88)	7.5	0.32	2.5					
	E41xxET-L ¹			•	957 (6.76)	3.8	1.21	9.0					
	E41xxEB-L ¹			•	974 (6.88)	3.7	1.27	10					
2 Stack	H42xxHC-L ¹	•			1650 (11.7)	14.7	0.12	3.3	1.3	0.16 (1.13)	18.2 (8.26)	140 (623)	400 (1780)
	H42xxLC-L ¹		•			7.4	0.47	13.3					
	H42xxHB-L ¹	•			1600 (11.3)	9.8	0.27	6.8					
	H42xxLB-L ¹		•			4.9	1.07	27.2					
	H42xxHT-L ¹	•			1580 (11.2)	7.9	0.41	9.8					
	H42xxLT-L ¹		•			4.0	1.62	39.2					
	H42xxHA-L ¹	•			1650 (11.7)	5.9	0.74	20.8					
	H42xxLA-L ¹		•			2.9	2.96	83.4					
	H42xxEC-L ¹			•	1170 (8.26)	10.4	0.24	3.3					
	H42xxEB-L ¹			•	1130 (7.98)	6.9	0.54	6.8					
	H42xxET-L ¹			•	1120 (7.91)	5.6	0.81	9.8					
	H42xxEA-L ¹			•	1170 (8.26)	4.1	1.48	20.8					

Note 1: Requires mounting to 10 in. x 10 in. x 1/4 in. thick aluminum plate to meet torque ratings and not exceed allowable temperature rise.

Continued on next page.

E4 / H4 Performance Data (continued)

	Motor Model Number	Config.			Holding Torque (2 phases on) oz-in (Nm) +/-10%	Rated Current/Phase Amps DC	Phase Resistance Ohms +/-10%	Phase Inductance mH Typical	Thermal Resistance Mounted °C/Watt	Rotor Inertia oz-in-s ² (kg-m ² x 10 ⁻³)	Weight lb (kg)	Shaft Loading	
		Parallel	Series	Unipolar								Radial Force lb (N)	Axial Force lb (N)
2 Stack Enhanced	E42xxHC-L ¹	•			2700 (19.1)	14.7	0.12	2.7	1.3	0.16 (1.13)	18.2 (8.26)	140 (623)	400 (1780)
	E42xxLC-L ¹		•			7.4	0.47	10.6					
	E42xxHB-L ¹	•			2600 (18.4)	9.8	0.27	5.4					
	E42xxLB-L ¹		•			4.9	1.07	21.7					
	E42xxHT-L ¹	•			2550 (18.0)	7.9	0.41	7.8					
	E42xxLT-L ¹		•			4.0	1.62	31.3					
	E42xxHA-L ¹	•			2690 (19.0)	5.9	0.74	16.6					
	E42xxLA-L ¹		•			2.9	2.96	66.5					
	E42xxEC-L ¹			•	1910 (13.5)	10.4	0.24	2.7					
	E42xxEB-L ¹			•	1840 (13.0)	6.9	0.54	5.4					
	E42xxET-L ¹			•	1810 (12.8)	5.6	0.81	7.8					
	E42xxEA-L ¹			•	1900 (13.4)	4.1	1.48	16.6					
3 Stack	H43xxHC-L ¹	•			2160 (15.3)	13.3	0.21	1.3	0.90	0.24 (1.69)	25.7 (11.7)	140 (623)	400 (1780)
	H43xxLC-L ¹		•			6.7	0.84	5.4					
	H43xxHB-L ¹	•			2260 (16.0)	12.5	0.24	1.8					
	H43xxLB-L ¹		•			6.2	0.96	7.0					
	H43xxHT-L ¹	•			2650 (18.7)	7.9	0.60	16.8					
	H43xxLT-L ¹		•			4.0	2.38	67.1					
	H43xxHA-L ¹	•			2340 (16.5)	5.0	1.48	40.8					
	H43xxLA-L ¹		•			2.5	5.9	163					
	H43xxEC-L ¹			•	1530 (10.8)	9.4	0.42	1.3					
	H43xxEB-L ¹			•	1600 (11.3)	8.8	0.48	1.8					
	H43xxET-L ¹			•	1870 (13.2)	5.6	1.19	16.8					
	H43xxEA-L ¹			•	1860 (13.1)	3.5	2.95	40.8					
3 Stack Enhanced	E43xxHC-L ¹	•			3720 (26.3)	13.3	0.21	3.7	0.90	0.24 (1.69)	25.7 (11.7)	140 (623)	400 (1780)
	E43xxLC-L ¹		•			6.7	0.84	14.7					
	E43xxHB-L ¹	•			3960 (28.0)	12.5	0.24	4.8					
	E43xxLB-L ¹		•			6.2	0.96	19.3					
	E43xxHT-L ¹	•			3930 (27.8)	7.9	0.60	11.8					
	E43xxLT-L ¹		•			4.0	2.38	47					
	E43xxHA-L ¹	•			3910 (27.6)	5.0	1.48	28.6					
	E43xxLA-L ¹		•			2.5	5.9	114					
	E43xxEC-L ¹			•	2670 (18.9)	9.4	0.42	3.7					
	E43xxEB-L ¹			•	2800 (19.8)	8.8	0.48	4.8					
	E43xxET-L ¹			•	2780 (19.6)	5.6	1.19	11.8					
	E43xxEA-L ¹			•	2760 (19.5)	3.5	2.95	28.6					

Note 1: Requires mounting to 10 in. x 10 in. x 1/4 in. thick aluminum plate to meet torque ratings and not exceed allowable temperature rise.

E / H Series Stepper Motors

E/H Encoder Options

Encoder Specifications

Parameter	Code	
	PD	PF
Type	Optical Incremental	
Supply Voltage	5 Vdc ±10%	
Lines per Revolution	500	1000
Output Format	Dual Channel Quadrature with Index (Z)	
Output Type	Differential Line Drive (with compliments)	
Output Frequency (kHz)	100	
Operating Temperature (°C)	-40 to 100	
Storage Temperature (°C)	-40 to 100	

PD Encoder Dimensional Drawings

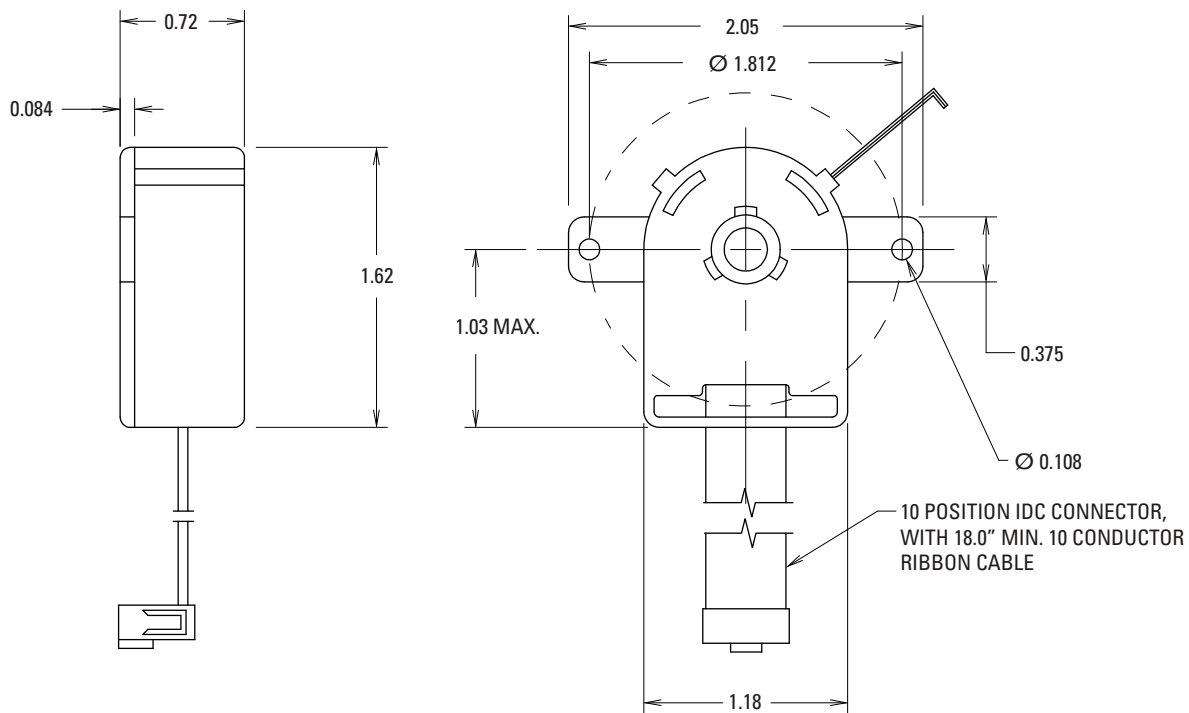

PF Encoder Dimensional Drawings

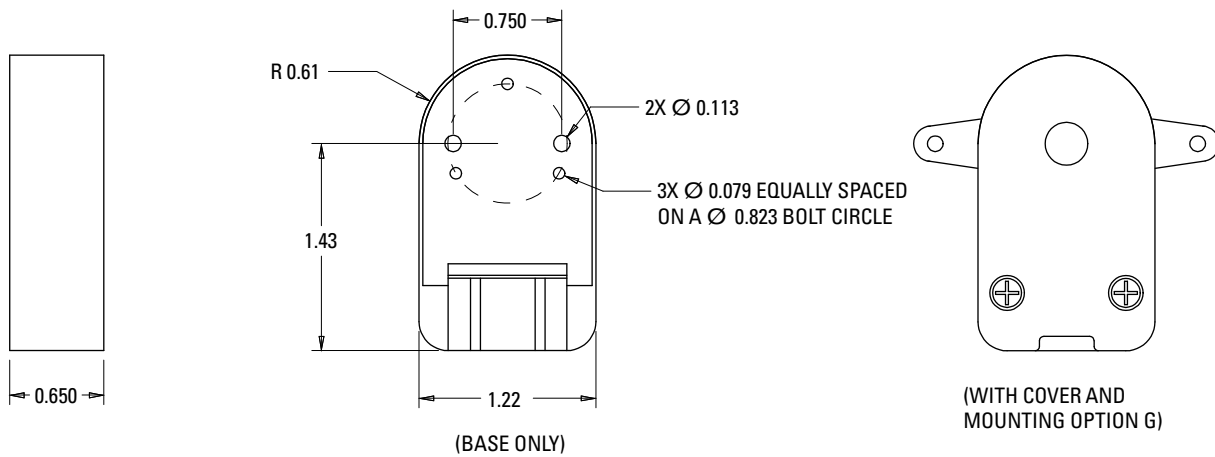

PD, PF Encoder Connection

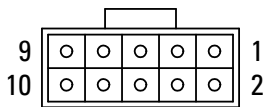

10-PIN Connector	Color	Function	MS Connector
1	Brown	N/C	-
2	Red	+5 V	G
3	Orange	GROUND	H
4	Yellow	N/C	-
5	Green	\bar{A}	A
6	Blue	A	B
7	Violet	\bar{B}	C
8	Gray	B	D
9	White	Z (Index)	E
10	Black	\bar{Z} (Index)	F

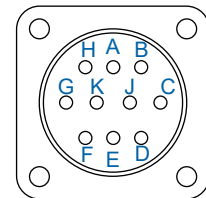

MS Connector MS3122E12-10P

Mating Plug Type MS3116F12-10S

PD, PF Encoder Phase Diagram

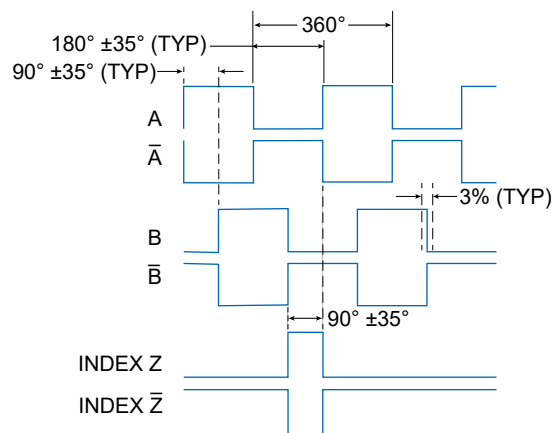

OUTPUT FORMAT FOR CCW ROTATION VIEWED FROM ENCODER END

MX Series Hazardous Duty Stepper Motors



UL, File E32246 (MX9) and E120721 (MX11)
Class I, Divisions 1 & 2, Group D

Explosion proof MX Series stepper motors are available in NEMA 34 and 42 frame sizes (90 and 110 mm). They move in 200 steps per revolution (1.8° step angle) and provide minimum holding torques from 1.27 to 9.82 N-m (180 to 1,390 oz-in). MX Series steppers are available with bipolar windings and a choice of stack lengths, providing speeds up to 3,000 rpm to meet the velocity demands of most high-torque applications.

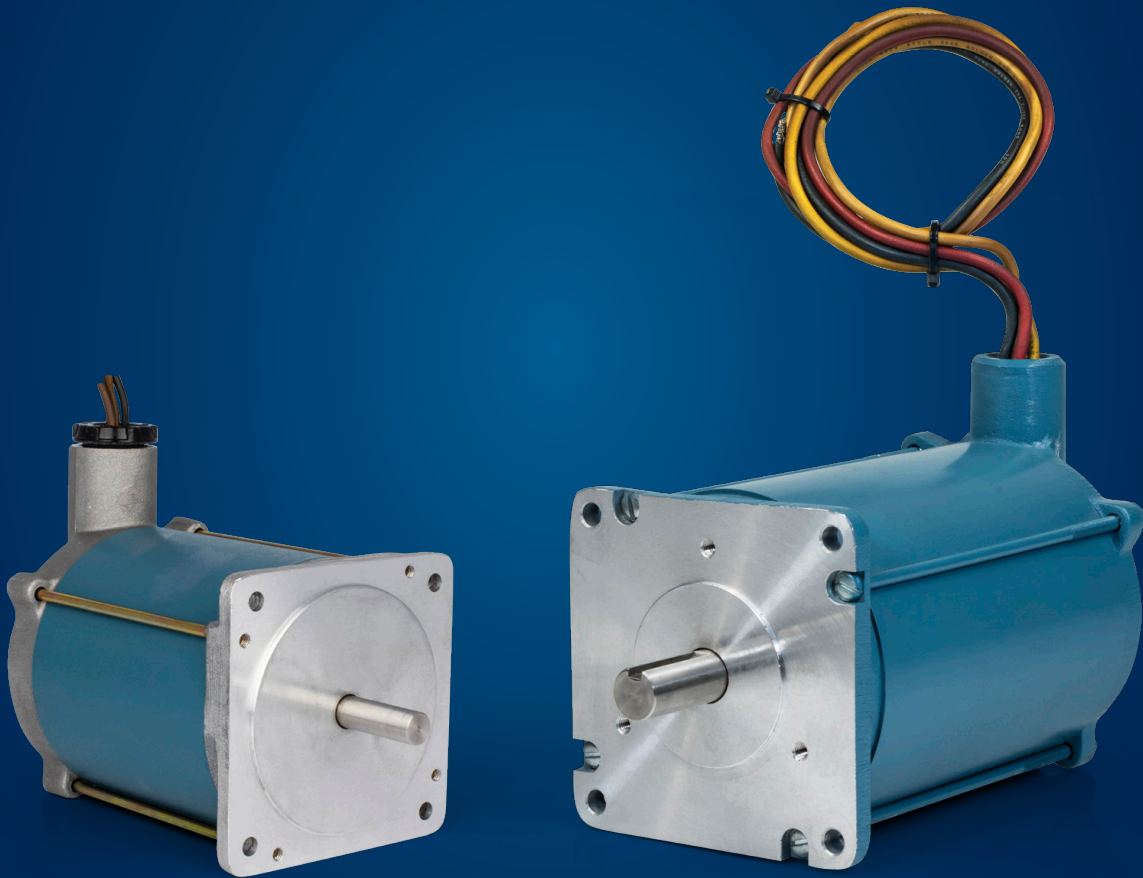

General Specifications

- » NEMA 34 and 42
- » Conventional hybrid stepper motor
- » Hazardous duty, UL Class 1, Division 1, Group D
- » CE compliant
- » Unipolar or Bipolar windings
- » Features: leadwire connection
- » Co-Engineered Options: Shaft Modifications, Special Windings



Parameter	MX9	MX11
NEMA frame size	34 (90 mm)	42 (110 mm)
Phases	2	
Full Steps per Revolution	200	
Step Angle (degrees)	1.8	
Step Accuracy % (of one full step, no load)	± 3.0 %	± 5.0 %
Operating Temperature	-20°C to +40°C	
Insulation Class	Class A, 105 °C	Class B, 130 °C
Insulation Voltage Rating	340 Vdc	
Insulation Resistance	100 Megohms	



MX Series Hazardous Duty Stepper Motors

MX Series Stepper Motor Connection Information

4-Lead Configuration

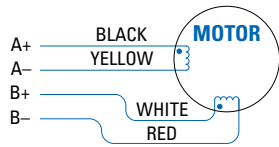

4-Lead Connection

Driver Connection	Lead Color
A	Black
\bar{A}	Yellow
B	White
\bar{B}	Red

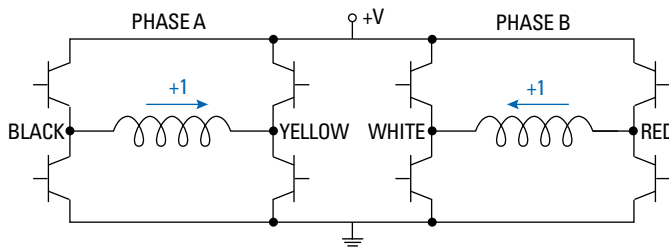

Full Step (One Phase On) Energizing Sequence

STEP	A	B
1	+1	0
2	0	-1
3	-1	0
4	0	+1
1	+1	0

Full Step (Two Phase On) Energizing Sequence

STEP	A	B
1	+1	+1
2	+1	-1
3	-1	-1
4	-1	+1
1	+1	+1

Half Step Energizing Sequence

STEP	A	B
1	+1	+1
2	+1	0
3	+1	-1
4	0	-1
5	-1	-1
6	-1	0
7	-1	+1
8	0	+1
1	+1	+1

MX Series Stepper Motor Nomenclature

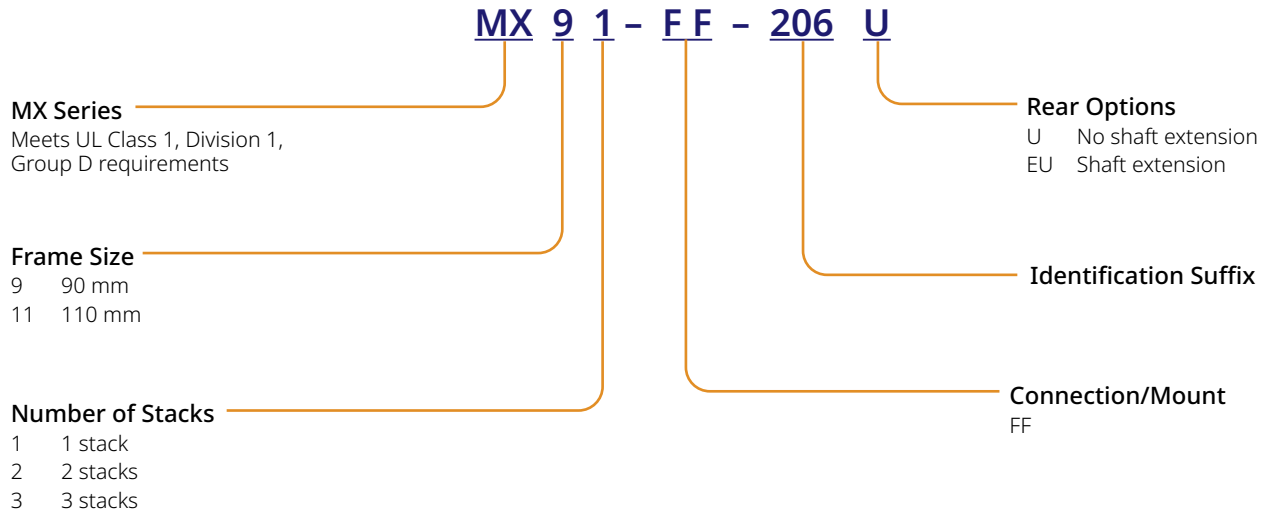

MX9 Series Hazardous Duty Stepper Motor

MX9 Specifications

- » NEMA 34
- » Conventional hybrid stepper motor
- » Hazardous duty, UL Class 1, Division 1, Group D
- » CE compliant
- » Unipolar or Bipolar windings
- » Features: leadwire connection
- » Co-Engineered Options: Shaft Modifications, Special Windings

Phases	2
Full Steps per Revolution	200
Step Angle	1.8°
Step Accuracy (of one full step, no load)	± 3 %
Operating Temperature	-20°C to +40°C
Insulation Class	Class A, 105°C
Insulation Voltage Rating	340 Vdc
Insulation Resistance	100 Megohms

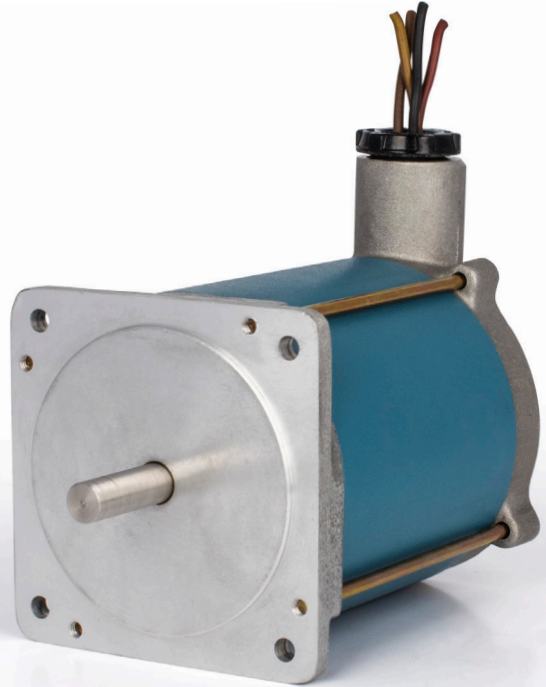

MX9 Outline Drawings

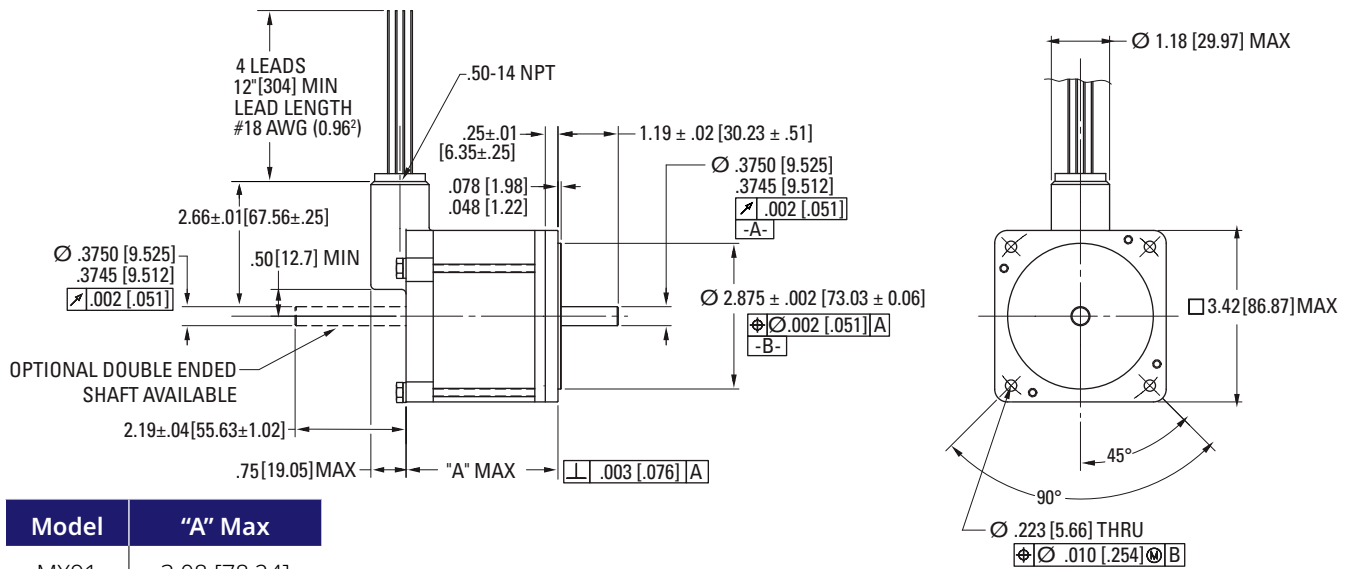

Dimensions in inches [mm]

Model	"A" Max
MX91	3.08 [78.24]
MX92	4.33 [110.0]
MX93	5.70 [144.8]

MX9 Performance Data

Motor Model Number	Config.			Holding Torque (2 Phases on) oz-in (Nm) +/-10%	Rated Current/Phase Amps DC	Phase Resistance Ohms +/-10%	Phase Inductance mH Typical	Thermal Resistance Mounted °C/Watt	Rotor Inertia oz-in-s ² (kg-m ² x 10 ⁻³)	Weight lb (kg)	Shaft Loading	
	Parallel	Series	Unipolar								Radial Force	Axial Force
				lb (N)	lb (N)							
MX91-FF-206U		•		180 (1.27)	3.0	1.0	10	2.9	0.0095 (0.067)	6.0 (2.7)	25 (111)	50 (222)
MX91-FF-402U		•			4.0	0.72	6.0					
MX91-FF-403U		•			6.0	0.18	1.5					
MX92-FF-206U		•		370 (2.61)	4.0	1.0	11	1.7	0.0174 (0.123)	9.0 (4.1)	25 (111)	50 (222)
MX92-FF-401U		•			7.0	0.28	2.8					
MX93-FF-206U		•		550 (3.88)	4.0	0.90	13	2.1	0.0265 (0.187)	11 (5.0)	25 (111)	50 (222)
MX93-FF-402U		•			7.0	0.16	2.0					

MX9 Performance Curves

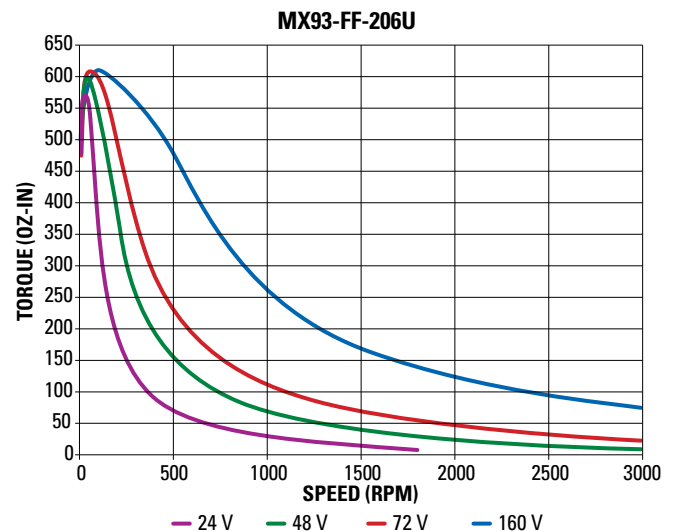
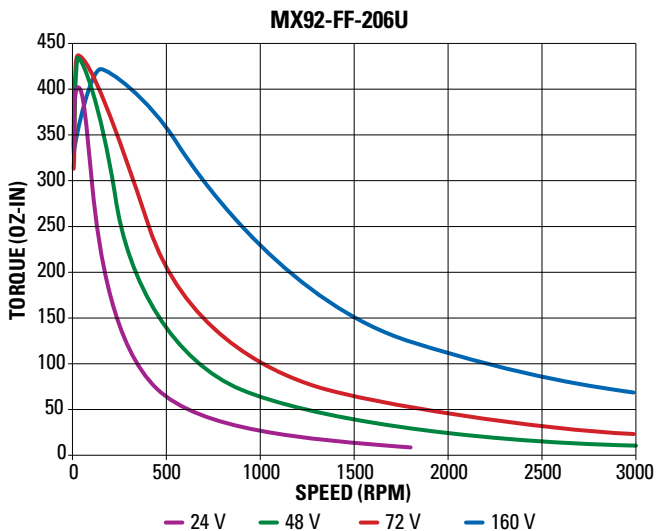
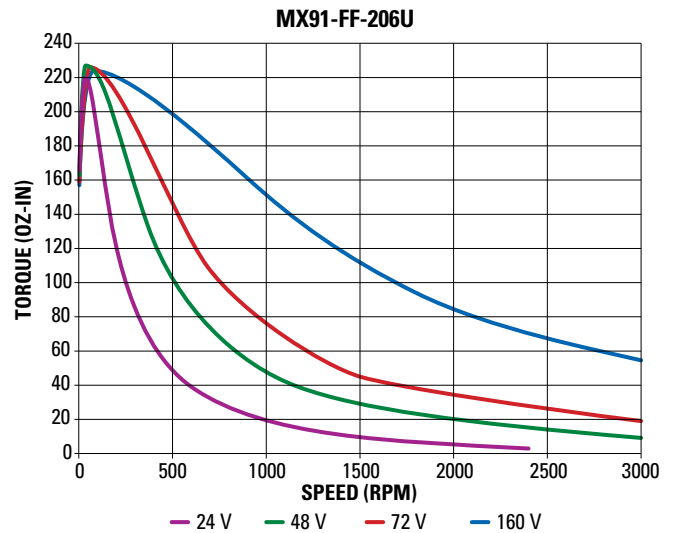

MX11 Series Hazardous Duty Stepper Motor

MX11 Specifications

- » NEMA 34
- » Conventional hybrid stepper motor
- » Hazardous duty, UL Class 1, Division 1, Group D
- » CE compliant
- » Unipolar or Bipolar windings
- » Features: leadwire connection
- » Co-Engineered Options: Shaft Modifications, Special Windings

Phases	2
Full Steps per Revolution	200
Step Angle	1.8°
Step Accuracy (of one full step, no load)	± 5 %
Operating Temperature	-20°C to +40°C
Insulation Class	Class B, 130°C
Insulation Voltage Rating	340 Vdc
Insulation Resistance	100 Megohms

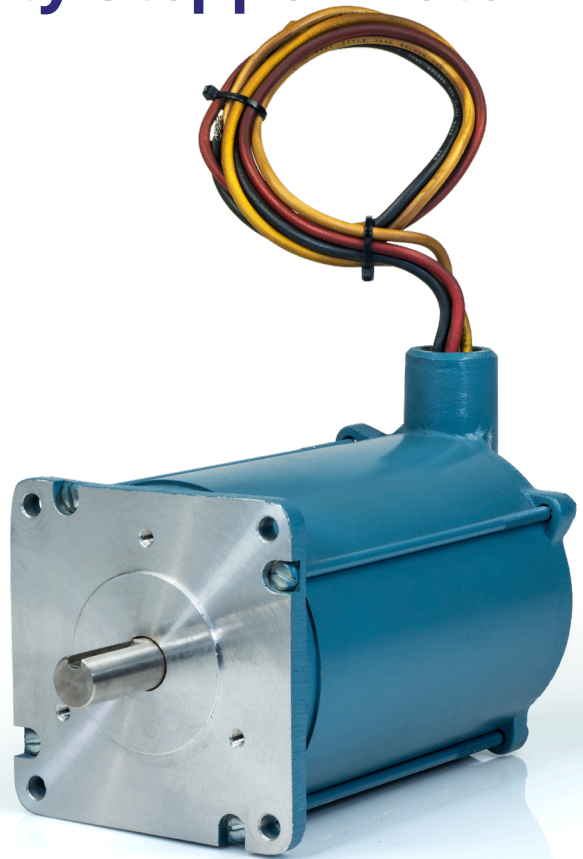

MX11 Outline Drawings

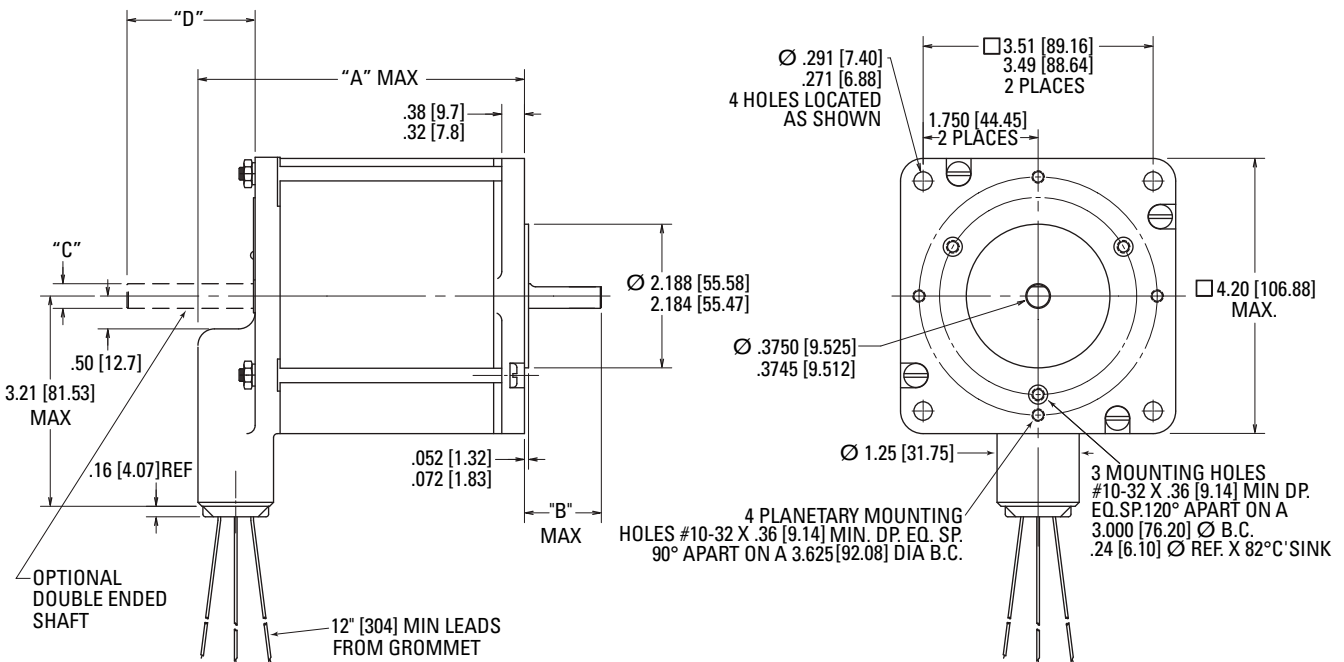

See next page for dimensions table and shaft details.

MX11 Outline Drawings (continued)

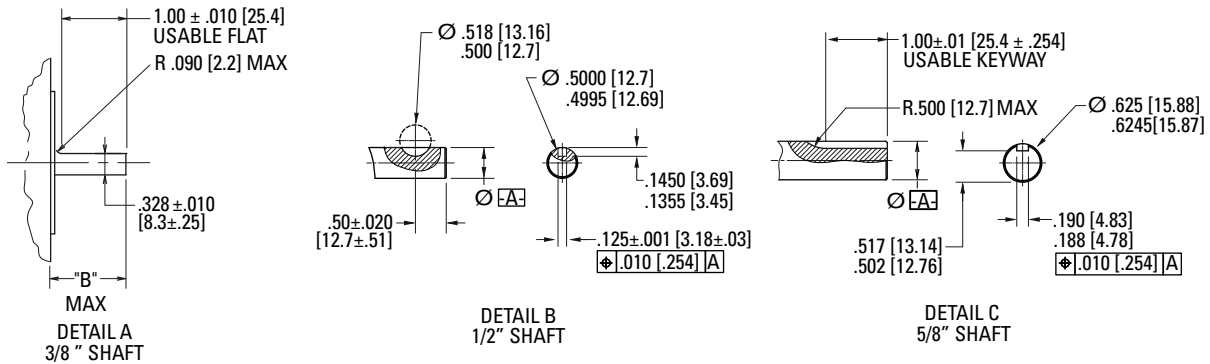

Dimensions in inches [mm]

Dimensions and Shaft Details

Model	"A" Max	"B" Max	"C"	"D"	Shaft Detail
MX111-FF-401U	5.06 [128.6]	1.25 [31.8]	Ø 0.375/0.3745 [9.525/9.512]	2.18 ± 0.14 [55.3]	A
MX112-FF-401U	7.45 [189.2]	1.38 [35.1]	Ø 0.5000/0.4995 [12.70/12.69]	1.258 ± 0.04 [31.55]	C

MX11 Performance Data

Motor Model Number	Config.			Holding Torque (2 Phases on)	Rated Current/Phase	Phase Resistance	Phase Inductance	Thermal Resistance	Rotor Inertia	Weight	Shaft Loading	
	Parallel	Series	Unipolar								Radial Force	Axial Force
				oz-in (Nm) +/-10%	Amps DC	Ohms +/-10%	mH Typical	Mounted °C/Watt	oz-in-s ² (kg-m ² x 10 ⁻³)	lb (kg)	lb (N)	lb (N)
MX111-FF-401U		•		850 (6.0)	1.1	3.6	16	7.4	0.055 (3.93)	10 (4.5)	25 (111)	50 (222)
MX112-FF-401U		•		1390 (9.82)	2.7	0.64	2.5	1.8	0.114 (8.06)	18 (8.2)	25 (111)	50 (222)

MX112 Performance Curve

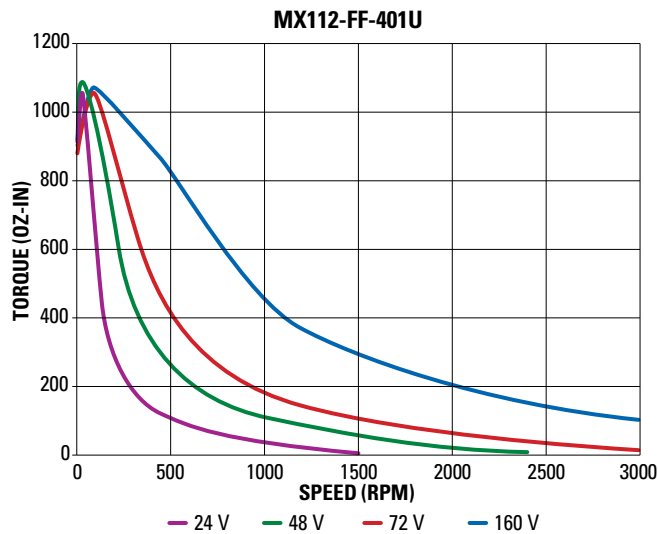

Stepper Motor Application Worksheet

Company _____ Date _____

MOTOR

circle or specify

Note: All motors are 1.8°, 2 Phase.

B - Pilot Diameter

A - Flange Width

E - Max Motor Length

F - Pilot Depth

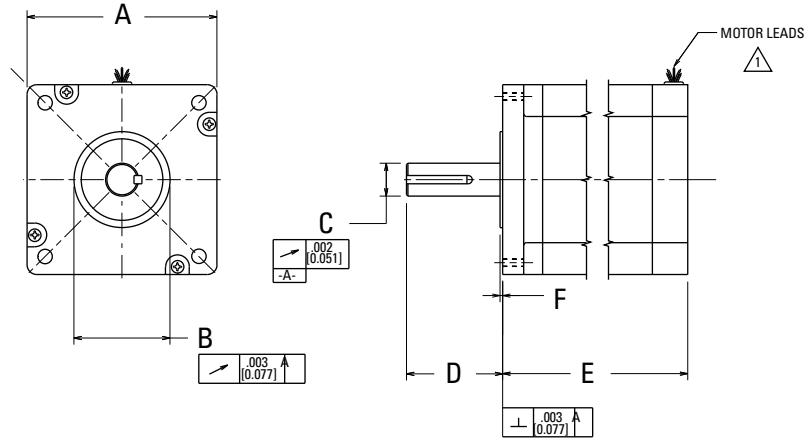

• STANDARD AND SPECIAL FEATURES

Motor model number from catalog:

Circle whether you want standard or special features. If special, indicate details. Note that special features may result in increased price or leadtime.

• FRONT SHAFT (standard) (special)

D shaft length _____ ± _____ (±.015)*

C shaft dia. _____ ± _____ (+.0000/- .0005)*

run out Δ _____ (.002 std. ext.)*

-- **Straight Key** per electric motor standards (standard option) (special)

Key: width _____ height _____

length _____ other _____

-- **Flat** See Fig. 1 (standard option) (special)

Min. usable length X _____

Dim. over flat Y _____ ± _____ (±.005)*

Corner radius R allowed _____ (±.060)*

Other _____

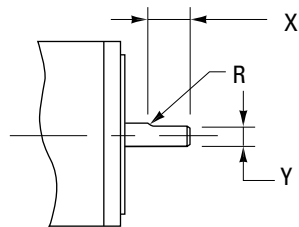

FIGURE 1

• REAR END BELL (standard) (special)

mtg. hole B.C. _____ ± _____ (±.010)*

mtg. holes _____

hole pattern _____

other _____

• REAR SHAFT (standard) (special)

shaft length _____ ± _____ (±.040)*

shaft dia. _____ ± _____ (+.0000/- .0005)*

run out Δ _____ (.002)*

other _____

-- **Woodruff Key** See Fig. 2 (standard option) (special)

ANSI std. key no. _____ (Example 303)

Key location Z _____ ± _____ (±.020)*

Other _____

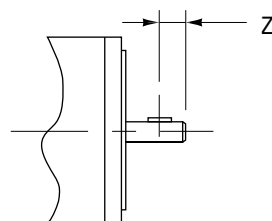

FIGURE 2

Notes:

Δ NEMA standard for shaft run out is .002" + .001" for each additional inch of extension past the standard length.

* Example of typical tolerance

Notes

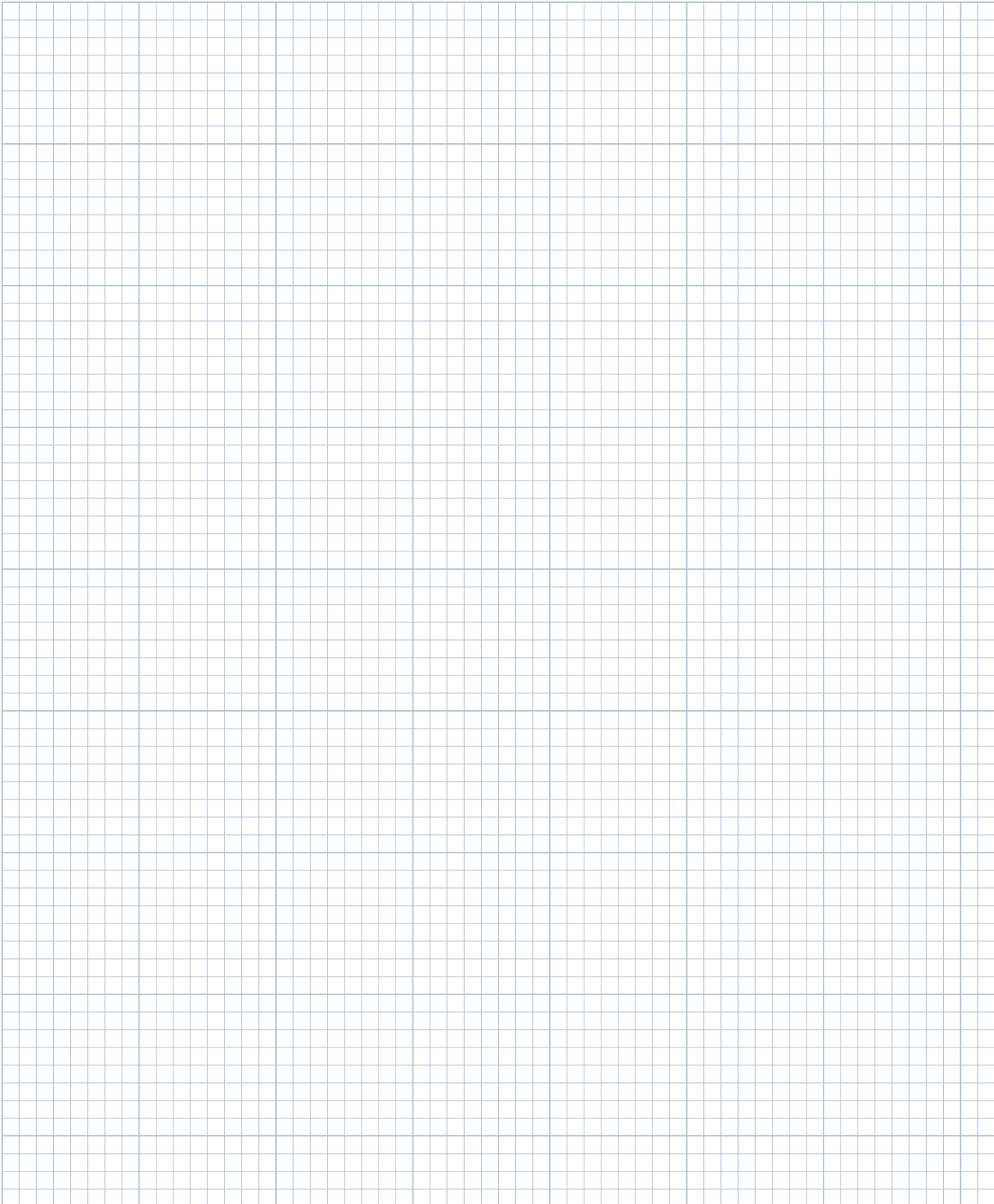

0.125 inch divisions

More Expertise for a More Successful Machine

Our global engineering, service and support network provides deep knowledge of all the major industries that rely on advanced motion control and automation technology. We offer world-class engineering expertise, self-service design tools, personalized field service, and easy access to our design, application and manufacturing centers in strategic locations across the globe.

About Kollmorgen

Kollmorgen, a Regal Rexnord brand, has more than 100 years of motion experience, proven in the industry's highest-performing, most reliable motors, drives, linear actuators, AGV (Automated Guided Vehicle) control solutions, and automation control platforms. We deliver breakthrough solutions that combine exceptional performance, reliability and ease of use, giving machine builders an irrefutable marketplace advantage.

KOLLMORGEN

A REGAL REXNORD BRAND

www.kollmorgen.com

Specifications are subject to change without notice. It is the responsibility of the product user to determine the suitability of this product for a specific application. All trademarks are the property of their respective owners

© 2024 Kollmorgen Corporation. All rights reserved

KM_SG_00091_RevD_EN