

AKD[®]-C and AKD[®]-N EtherCAT Communication



Edition: A, May 2014

Valid for firmware version 1.12

Part Number 903-200023-00

Original Documentation

EtherCAT[®]

Keep all manuals as a product component during the life span of the product.
Pass all manuals to future users and owners of the product.

KOLLMORGEN[®]

Because Motion Matters[™]

Record of Document Revisions

Revision	Remarks
...	Table with lifecycle information of this document see "Record of Document Revisions" (→ p. 144)
A, 05/2014	First edition

Trademarks

- AKD is a registered trademark of Kollmorgen Corporation
- EnDat is a registered trademark of Dr. Johannes Heidenhain GmbH
- EtherCAT is a registered trademark and patented technology, licensed by Beckhoff Automation GmbH
- HIPERFACE is a registered trademark of Max Stegmann GmbH
- Windows is a registered trademark of Microsoft Corporation

Current patents

- US Patent 5,162,798 (used in control card R/D)
- US Patent 5,646,496 (used in control card R/D and 1 Vp-p feedback interface)
- US Patent 6,118,241 (used in control card simple dynamic braking)
- US Patent 8,154,228 (Dynamic Braking For Electric Motors)
- US Patent 8,214,063 (Auto-tune of a Control System Based on Frequency Response)

Technical changes which improve the performance of the device may be made without prior notice!

Printed in the United States of America

This document is the intellectual property of Kollmorgen. All rights reserved. No part of this work may be reproduced in any form (by photocopying, microfilm or any other method) or stored, processed, copied or distributed by electronic means without the written permission of Kollmorgen.

1 Table of Contents

1	Table of Contents	3
2	General	7
2.1	About this Manual	8
2.2	Target Group	8
2.3	Symbols Used	9
2.4	Abbreviations Used	10
3	Installation and Setup	11
3.1	Important Instructions	12
3.2	EtherCAT Onboard	13
3.2.1	LED functions	13
3.2.2	Connection technology	13
3.2.3	Network Connection Example	13
3.3	Guide to Setup	14
3.4	Setup via TwinCAT NC/PTP System Manager	14
3.4.1	Scan devices	15
3.4.2	Select the device	15
3.4.3	Scan for boxes	16
3.4.4	Add Slaves to NC tasks	16
3.4.5	Enable the network configuration	16
3.4.6	Enable the axis and move the axis	17
3.5	Setup WorkBench over TwinCAT	18
3.5.1	TwinCAT and WorkBenchconfiguration	19
3.5.2	Connecting to a drive using WorkBench	20
3.5.3	Configuring and enabling a drive	23
3.5.4	Download a parameterfile over TwinCAT	24
3.6	Setup via KAS IDE	25
4	EtherCAT Profile	26
4.1	Slave Register	27
4.2	AL Event (Interrupt Event) and Interrupt Enable	28
4.2.1	Interrupt Enable Register (Address 0x0204:0x0205)	28
4.2.2	AL Event Request (Address 0x0220:0x0221)	29
4.3	Phase Run-Up	30
4.3.1	AL Control (Address 0x0120:0x0121)	30
4.3.2	AL Status (Address 0x0130:0x0131)	30
4.3.3	AL Status Code (Address 0x0134:0x0135)	31
4.3.4	EtherCAT communication phases	31
4.4	CANopen over EtherCAT (CoE) Status Machine	32
4.4.1	Status Description	32
4.4.2	Commands in the Control Word	33
4.4.3	Status Machine Bits (status word)	34
4.5	Fixed PDO Mappings	35
4.6	Flexible PDO Mappings	37
4.6.1	Example: Flexible PDO Mapping	38

4.7 Supported Cyclical Setpoint and Actual Values	42
4.8 Supported Operation Modes	44
4.9 Adjusting EtherCAT Cycle Time	44
4.10 Maximum Cycle Times depending on operation mode	44
4.11 Synchronization	45
4.11.1 Synchronization behavior with distributed clocks (DC) enabled	45
4.11.2 Synchronization behavior with distributed clocks (DC) disabled	45
4.12 Latch Control Word and Latch Status Word	46
4.13 Mailbox Handling	47
4.13.1 Mailbox Output	48
4.13.2 Mailbox Input	49
4.13.3 Example: Mailbox Access	50
4.14 Fieldbus Parameters	51
4.15 EEPROM Content	52
5 Appendix	53
5.1 CANopen Emergency Messages and Error Codes	53
5.2 Object Dictionary AKD-C	58
5.2.1 Float Scaling	58
5.2.2 Object Dictionary for AKD-C	58
5.3 Object Dictionary AKD-N	60
5.3.1 Float Scaling	60
5.3.2 Communication SDOs	60
5.3.3 Manufacturer specific SDOs	63
5.3.4 Profile specific SDOs	77
5.4 Object descriptions	80
5.4.1 Object 1000h: Device Type (DS301)	80
5.4.2 Object 1001h: Error register (DS301)	81
5.4.3 Object 1002h: Manufacturer Status Register (DS301)	82
5.4.4 Object 1003h: Predefined Error Field (DS301)	83
5.4.5 Object 1005h: COB-ID of the SYNC Message (DS301)	84
5.4.6 Object 1006h: Communication Cycle Period (DS301)	84
5.4.7 Object 1008h: Manufacturer Device Name (DS301)	85
5.4.8 Object 1009h: Manufacturer Hardware Version	85
5.4.9 Object 100Ah: Manufacturer Software Version (DS301)	85
5.4.10 Object 100Ch: Guard Time (DS301)Response monitoring	86
5.4.11 Object 100Dh: Lifetime Factor (DS301)	86
5.4.12 Object 1010h: Store Parameters (DS301)	87
5.4.13 Object 1011h: Restore Default Parameters DS301	88
5.4.14 Object 1012h: COB-ID of the Time Stamp (DS301)	89
5.4.15 Object 1014h: COB-ID for Emergency Message (DS301)	89
5.4.16 Object 1016h: Consumer Heartbeat Time	90
5.4.17 Object 1017h: Producer Heartbeat Time	91
5.4.18 Object 1018h: Identity Object (DS301)	91
5.4.19 Object 1026h: OS Prompt	93
5.4.20 Objects 1400-1403h: 1st - 4th RXPDO communication parameter (DS301)	94
5.4.21 Objects 1600-1603h: 1st - 4th RXPDO mapping parameter (DS301)	95

5.4.22 Objects 1800-1803h: 1st - 4th TXPDO communication parameter (DS301)	96
5.4.23 Objects 1A00-1A03h: 1st - 4th TXPDO mapping parameter (DS301)	98
5.4.24 Object 2000h: System Warnings	99
5.4.25 Object 2001h: System Faults	99
5.4.26 Object 2002h: Manufacturer status bytes	100
5.4.27 Object 2014-2017h: 1st-4th Mask 1 to 4 for Transmit-PDO	101
5.4.28 Object 2018h: Firmware Version	102
5.4.29 Object 2026h: ASCII Channel	103
5.4.30 Object 204Ch: PV Scaling Factor	104
5.4.31 Object 2071h: Target Current	105
5.4.32 Object 2077h: Current Actual Value	105
5.4.33 Object 20A0h: Latch position 1, positive edge	105
5.4.34 Object 20A1h: Latch position 1, negative edge	106
5.4.35 Object 20A2h: Latch position 2, positive edge	106
5.4.36 Object 20A3h: Latch position 2, negative edge	107
5.4.37 Object 20A4h: Latch Control Register	107
5.4.38 Object 20A5h: Latch Status Register	108
5.4.39 Object 20A6h: Latch position 1, positive or negative edge	108
5.4.40 Object 20A7h: Latch position 2, positive or negative edge	109
5.4.41 Object 20B8h: Reset of changed input information	109
5.4.42 Object 345Ah: Brake Control	110
5.4.43 Object 3474h: Parameters for digital inputs	112
5.4.44 Object 3475h: Parameters for digital outputs	113
5.4.45 Object 3496h: Fieldbus synchronization parameters	114
5.4.46 Object 6040h: Control word (DS402)	116
5.4.47 Object 6041h: Status word (DS402)	117
5.4.48 Object 6060h: Modes of Operation (DS402)	119
5.4.49 Object 6061h: Modes of Operation Display (DS402)	120
5.4.50 Object 6063h: position actual value* (DS402)	120
5.4.51 Object 6064h: position actual value (DS402)	120
5.4.52 Object 6065h: Following error window	121
5.4.53 Object 606Ch: Velocity actual value (DS402)	121
5.4.54 Object 6071h: Target torque (DS402)	122
5.4.55 Object 6073h: Max current (DS402)	122
5.4.56 Object 6077h: Torque actual value (DS402)	122
5.4.57 Object 607Ah: Target position (DS402)	123
5.4.58 Object 607Ch: Homing offset (DS402)	123
5.4.59 Object 607Dh: Software position limit (DS402)	124
5.4.60 Object 6081h: Profile velocity (DS402)	125
5.4.61 Object 6083h: Profile acceleration (DS402)	125
5.4.62 Object 6084h: Profile deceleration (DS402)	125
5.4.63 Object 608Fh: Position encoder resolution (DS402)	126
5.4.64 Object 6091h: Gear Ratio (DS402)	127
5.4.65 Object 6092h: Feed constant (DS402)	128
5.4.66 Object 6098h: Homing method (DS402)	129
5.4.67 Object 6099h: Homing speeds (DS402)	130

5.4.68 Object 609Ah: Homing acceleration (DS402)	131
5.4.69 Object 60B1h: Velocity Offset	131
5.4.70 Object 60B2h: Torque Offset	131
5.4.71 Object 60B8h: Touch probe function	132
5.4.72 Object 60B9h: Touch probe status	133
5.4.73 Object 60BAh: Touch probe 1 positive edge	134
5.4.74 Object 60BBh: Touch probe 1 negative edge	134
5.4.75 Object 60BCh: Touch probe 2 positive edge	134
5.4.76 Object 60BDh: Touch probe 2 negative edge	135
5.4.77 Object 60C0h: Interpolation sub mode select	135
5.4.78 Object 60C1h: Interpolation data record	136
5.4.79 Object 60C2h: Interpolation time period	137
5.4.80 Object 60C4h: Interpolation data configuration	138
5.4.81 Object 60D0h: Touch probe source	140
5.4.82 Object 60F4h: Following error actual value (DS402)	140
5.4.83 Object 60FDh: Digital inputs (DS402)	141
5.4.84 Object 60FEh: Digital outputs (DS402)	142
5.4.85 Object 60FFh: Target velocity (DS402)	143
5.4.86 Object 6502h: Supported drive modes (DS402)	143
6 Record of Document Revisions	144
7 Index	145

2 General

2.1 About this Manual	8
2.2 Target Group	8
2.3 Symbols Used	9
2.4 Abbreviations Used	10

2.1 About this Manual

This manual, *AKD-C/N EtherCAT Communication*, describes the installation, setup, range of functions, and software protocol for the decentral drive system with AKD-C and AKD-N devices.

A digital version of this manual (pdf format) is available on the DVD included with your device. Document updates can be downloaded from the Kollmorgen website.

Related documents for the AKD-C/N series include:

- *AKD-C Installation Manual* This manual provides instructions for installation and device setup.
- *AKD-N Installation Manual* This manual provides instructions for installation and drive setup.
- *AKD User Guide*. This manual describes how to use your drive in common applications. It also provides tips for maximizing your system performance with the AKD. The *User Guide* includes the *Parameter and Command Reference Guide* which provides documentation for the parameters and commands used to program the AKD-C and AKD-N.
- *Accessories Manual*. This manual provides documentation for accessories like cables and regen resistors used with AKD-C and AKD-N. Regional versions of this manual exist.

Additionally, an EtherCAT XML file, entitled *AKD EtherCAT Device Description*, describes the drive SDO and PDO. This file is available on the Kollmorgen website (part of the firmware zip archive).

2.2 Target Group







This manual addresses personnel with the following qualifications:

- Installation: only by electrically qualified personnel.
- Setup : only by qualified personnel with extensive knowledge of electrical engineering and drive technology.
- Programming: software developers, project-planners.

The qualified personnel must know and observe the following standards:

- ISO 12100, IEC 60364 and IEC 60664
- National accident prevention regulations

2.3 Symbols Used

Symbol	Indication
 DANGER	Indicates a hazardous situation which, if not avoided, will result in death or serious injury.
 WARNING	Indicates a hazardous situation which, if not avoided, could result in death or serious injury.
 CAUTION	Indicates a hazardous situation which, if not avoided, could result in minor or moderate injury.
NOTICE	Indicates situations which, if not avoided, could result in property damage.
NOTE	This symbol indicates important notes.
	Warning of a danger (general). The type of danger is specified by the text next to the symbol.
	Warning of danger from electricity and its effects.
	Warning of suspended loads.

2.4 Abbreviations Used

Abbreviation	Meaning
AL	Application Layer: the protocol that directly used by the process entities.
Cat	Category – classification for cables that is also used in Ethernet.
DC	Distributed Clocks Mechanism to synchronize EtherCAT slaves and master
DL	Data Link(=Layer 2). EtherCAT uses Ethernet, which is standardized as IEEE 802.3.
FPGA	Field Programmable Gate Array
FTP	File Transfer Protocol
HW	Hardware
ICMP	Internet Control Message Protocol: Mechanisms for signaling IP errors.
IEC	International Electrotechnical Commission: The international standards
IEEE	Institute of Electrical and Electronics Engineers, Inc.
LLDP	Link Layer Discovery Protocol
MAC	Media Access Control
MII	Media Independent Interface: Standardized interface Ethernet controller <-> routing equipment.
MDI	Media Dependant Interface: Use of connector Pins and Signaling.
MDI-X	Media Dependant Interface (crossed): Use of connector Pins and Signaling with crossed lines.
OSI	Open System Interconnect
OUI	Organizationally Unique Identifier – the first 3 Bytes of an Ethernet-Address, that will be assign to companies or organizations and can be used for protocoll identifiers as well (e.g. LLDP)
PDI	Physical Device Interface: set of elements that allows access to ESC from the process side.
PDO	Process Data Object
PDU	Protocol Data Unit: Contains protocol information transferred from a protocol instance of transparent data to a subordinate level
PHY	Physical interface that converts data from the Ethernet controller to electric or optical signals.
PLL	Phase Locked Loop
PTP	Precision Time Protocol in accordance with IEEE 1588
RSTP	Rapid Spanning Tree Protocol
RT	Real-time, can be run in Ethernet controllers without special support.
RX	Receive
RXPDO	Receive PDO
SNMP	Simple Network Management Protocol
SPI	Serial Peripheral Interface
Src Addr	Source Address: Source address of a message.
STP	Shielded Twisted Pair
TCP	Transmission Control Protocol
TX	Transmit
TXPDO	Transmit PDO
UDP	User Datagram Protocol: Non-secure multicast/broadcast frame.
UTP	Unshielded Twisted Pair
ZA ECAT	Access mode EtherCAT
ZA Drive	Acces mode drive

3 Installation and Setup

3.1 Important Instructions	12
3.2 EtherCAT Onboard	13
3.3 Guide to Setup	14
3.4 Setup via TwinCAT NC/PTP System Manager	14
3.5 Setup WorkBench over TwinCAT	18
3.6 Setup via KAS IDE	25

3.1 Important Instructions



WARNING

Electronic equipment is basically not failure-proof. The user is responsible for ensuring that, in the event of a failure of the drive, the drive is set to a state that is safe for both machinery and personnel, for instance with the aid of a mechanical brake.

Drives with EtherCAT are remote-controlled machines. They can start to move at any time without previous warning. Take appropriate measures to ensure that the operating and service personnel is aware of this danger.

Implement appropriate protective measures to ensure that any unintended start-up of the machines cannot result in dangerous situations for personnel or machinery. Software limit-switches are not a substitute for the hardware limit-switches in the machine.

NOTICE

Install the drive as described in the *Installation Manual*. The wiring for the analog setpoint input and the positioning interface, as shown in the wiring diagram in the *Installation Manual*, is not required. Never break any of the electrical connections to the drive while it is live. This action can result in destruction of the electronics.

NOTICE

The drive's status must be monitored by the PLC to acknowledge critical situations. Wire the FAULT contact in series into the emergency stop circuit of the installation. The emergency stop circuit must operate the supply contactor.

NOTE

It is permissible to use the setup software to alter the settings of the drive. Any other alterations will invalidate the warranty. Because of the internal representation of the position-control parameters, the position controller can only be operated if the final limit speed of the drive does not exceed:

rotary

at sinusoidal² commutation: 7500 rpm

at trapezoidal commutation: 12000 rpm.

linear

at sinusoidal² commutation: 4 m/s

at trapezoidal commutation: 6.25 m/s

NOTE

All the data on resolution, step size, positioning accuracy etc. refer to calculatory values. Non-linearities in the mechanism (backlash, flexing, etc.) are not taken into account. If the final limit speed of the motor must be altered, then all the parameters that were previously entered for position control and motion blocks must be adapted.

3.2 EtherCAT Onboard

Connection to the EtherCAT Network via X10 (in port) and X11 (out port).

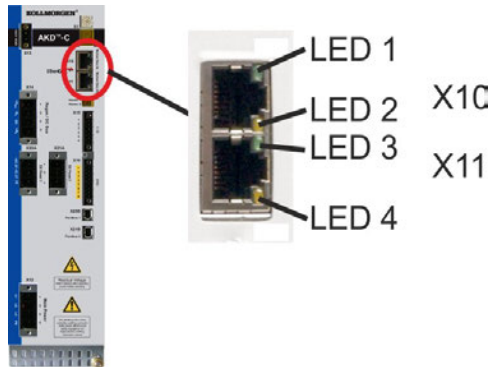

3.2.1 LED functions

The communication status is indicated by the built-in LEDs.

Connector	LED#	Name	Function
X10	LED1	IN port Link	ON = active OFF = not active
	LED2	RUN	ON = running OFF = not running
X11	LED3	OUT port Link	ON = active OFF = not active
	LED4	-	-

3.2.2 Connection technology

You can connect to the EtherCAT network using RJ-45 connectors.

3.2.3 Network Connection Example



3.3 Guide to Setup

NOTICE

Only professional personnel with extensive knowledge of control and drive technology are allowed to setup the drive.



CAUTION

Drives with EtherCAT are remote-controlled machines. They can start to move at any time without previous warning. Take appropriate measures to ensure that the operating and service personnel is aware of this danger.

Implement appropriate protective measures to ensure that any unintended start-up of the machines cannot result in dangerous situations for personnel or machinery. Software limit-switches are not a substitute for the hardware limit-switches in the machine.

1. Check assembly/installation. Check that all the safety instructions in the product manual for the drive and this manual have been observed and implemented. Check the setting for the station address and baud rate.
2. Connect PC, start WorkBench. Use the setup software WorkBench to set the parameters for the drive.
3. Setup basic functions. Start up the basic functions of the drive and optimize the current, speed and position controllers. This section of the setup is described in the in the online help of the setup software.
4. Save parameters. When the parameters have been optimized, save them in the drive.

3.4 Setup via TwinCAT NC/PTP System Manager

Before you set up the drive, make sure the following have been completed:

- The AKD is configured with WorkBench and the servomotor is able to move
- A correctly configured EtherCAT card is present in the master.
- TwinCAT software from Beckhoff (NC/PTP-Mode setup) is installed. Install first the TwinCAT System Manager, restart your PC, then install the option package NC/PTP-Mode.
- The XML description of the drive is available (the XML file on the DVD or on the Kollmorgen website).
- An AKD EtherCAT slave is connected to the EtherCAT master PC.
- The TwinCAT system manager resides in Config-Mode. The current mode of the system manager is displayed of the bottom right side of the TwinCAT main-screen window.

Copy the XML description of the drive to the TwinCAT system (usually to the folder c:\TwinCAT\IO\EtherCAT) and restart the TwinCAT system since TwinCAT analyzes all device description files during start-up.

The following example explains the automatic EtherCAT network setup. The network setup can also be done manually; please refer to the TwinCAT manual for more details.

3.4.1 Scan devices

First ensure that the EtherCAT master is physically connected to the EtherCAT AKD. Create a new (empty) project. Right click I/O-Devices and scan for the devices. An example is included in the EtherCAT network card, which is plugged into the PC.

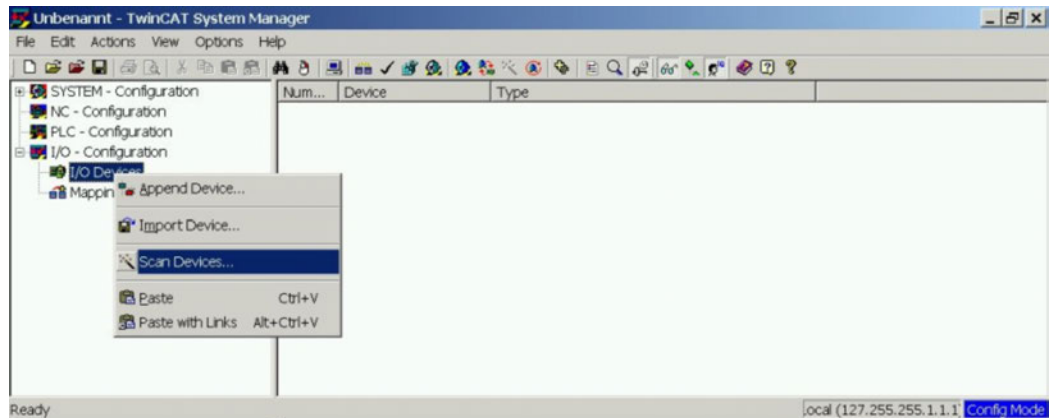

A pop-up window informs you that not all devices can be detected by the TwinCAT software. Click **OK** to continue.

3.4.2 Select the device

TwinCAT must be able to find the EtherCAT network card. An EtherCAT slave must be connected to the network card; otherwise TwinCAT will find a real-time EtherNET card instead of the EtherCAT card. Press the **OK** button.

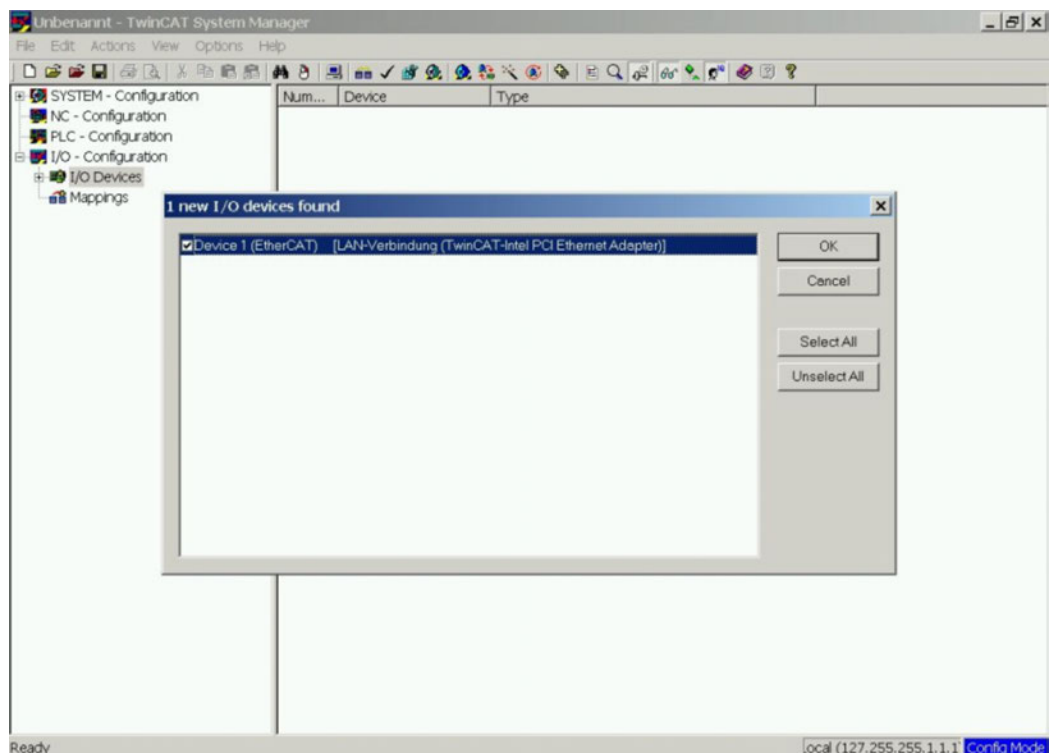

3.4.3 Scan for boxes

Click **Yes** to allow TwinCAT to scan for boxes. A *box* is an alias for a slave device and is always used in Beckhoff software products.

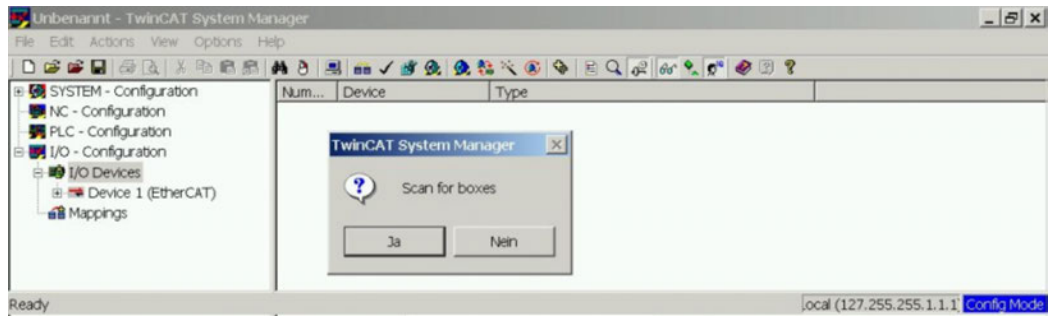

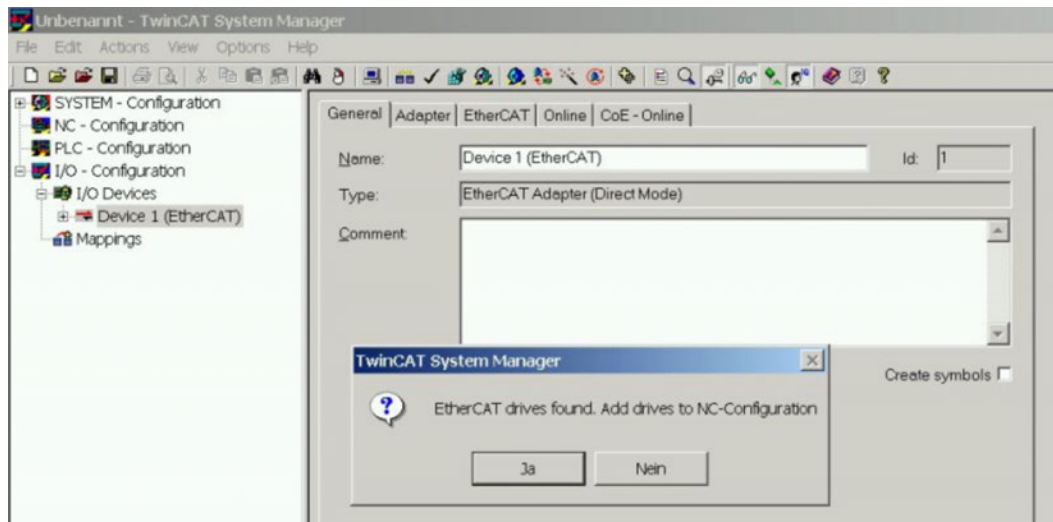

3.4.4 Add Slaves to NC tasks

TwinCAT should now have identified the AKD according to the Device Description file. TwinCAT next asks if the slaves should be connected to NC tasks. Click **Yes** to continue. An NC task can, for example, contain a PLC program, which can be programmed by the user.



3.4.5 Enable the network configuration

Confirm that the AKD appears in the device tree. Next, enable the network configuration

Press first the  button in order to generate the mappings, afterwards press the  button in order to let TwinCAT check the configuration and use finally the  button in order to step into run-mode.

Confirm afterwards that TwinCAT is allowed to jump into run-mode.

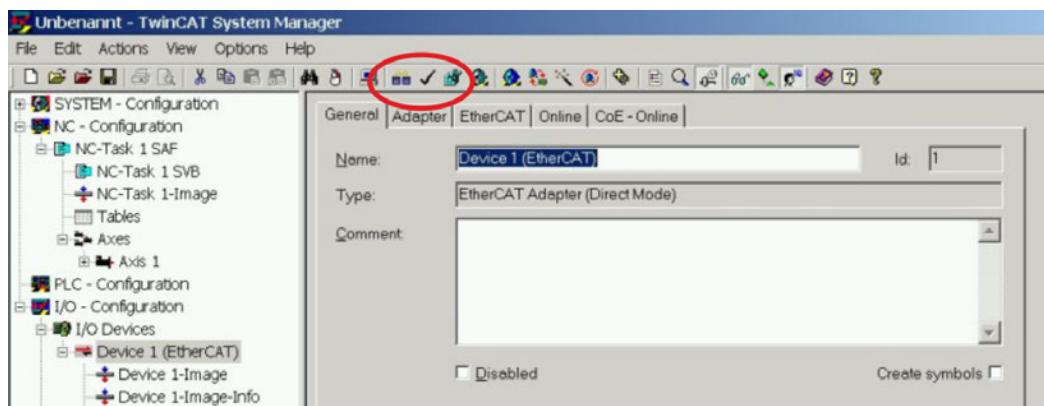

3.4.6 Enable the axis and move the axis

The Axis can be enabled by a mouse-click on the Set button within the Online window inside of each Axis, see also the next picture.

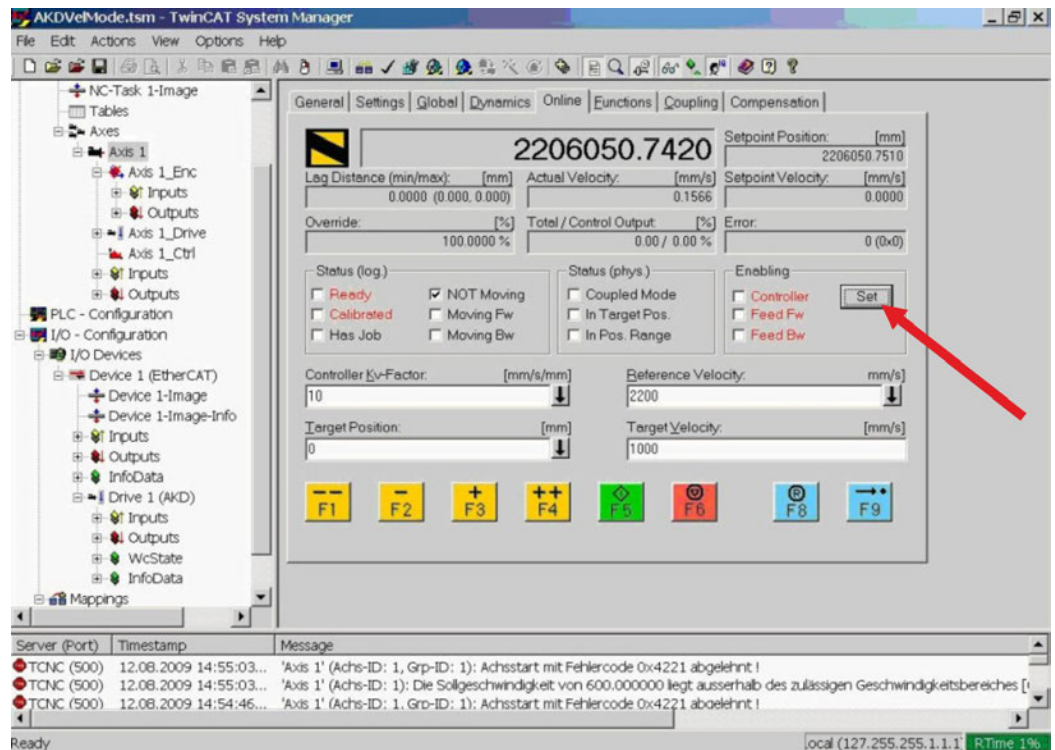

Afterwards a pop-up window appears.

The following setting enables the drive and allows command values in both directions.

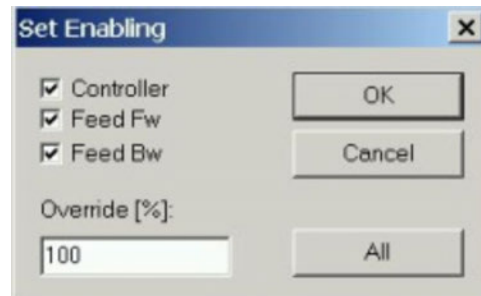

Afterwards the motor should move in positive or negative direction as soon as the clicks on the following yellow buttons within the Online window:



3.5 Setup WorkBench over TwinCAT

This chapter describes a quick start guide for a user to be able to setup a WorkBench over TwinCAT system and be able to make a motor spin under that system.

This chapter does not give any specific details on TwinCAT system or WorkBench alone but is giving guidelines and information on how TwinCAT master and WorkBench works together.

Main steps in configuring a WorkBench over TwinCAT system are:

- TwinCAT and WorkBench configuration
- Connecting to a drive using WorkBench
- Configuring and enabling a drive

3.5.1 TwinCAT and WorkBench configuration

The EtherCAT network must be setup and managed using TwinCAT System Manager. To be able to connect to a drive and enable it, the drive must be loaded under the I/O Devices node in TwinCAT System Manager and axis must be added to NC - Configuration as shown → p. 14 "Setup via TwinCAT NC/PTP System Manager " in the EtherCAT Manual.

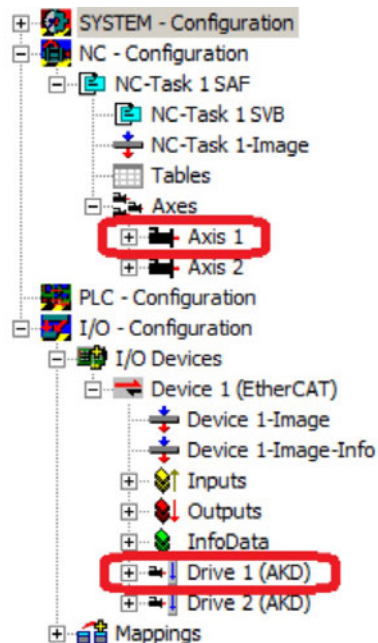

In order to connect to the drives using WorkBench, the drives must be either in Pre-Op, Safe-Op or Op state. State machine for a drive can be accessed from the Online tab for the corresponding drive under the I/O Configuration → I/O Devices → Device [x] → Drive [x] node (see screenshot below).

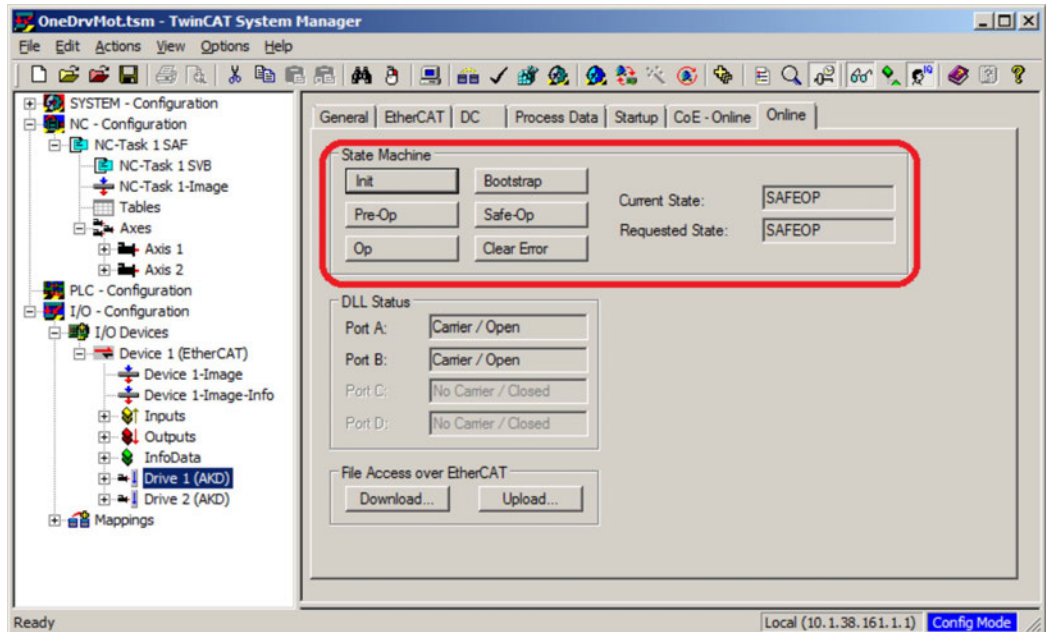

Installation process for WorkBench is the same process as normal, except that it must be installed on the same machine as TwinCAT. Communication to the drive is done thru TwinCAT master and it's not possible to connect WorkBench to the master remotely.

3.5.2 Connecting to a drive using WorkBench

In order to connect to a drive, a TwinCAT device must be added in WorkBench. The start page of WorkBench can be used to do this. First, the type of drive (Online - TwinCAT) must be specified. Then, a list of available drives will be provided.

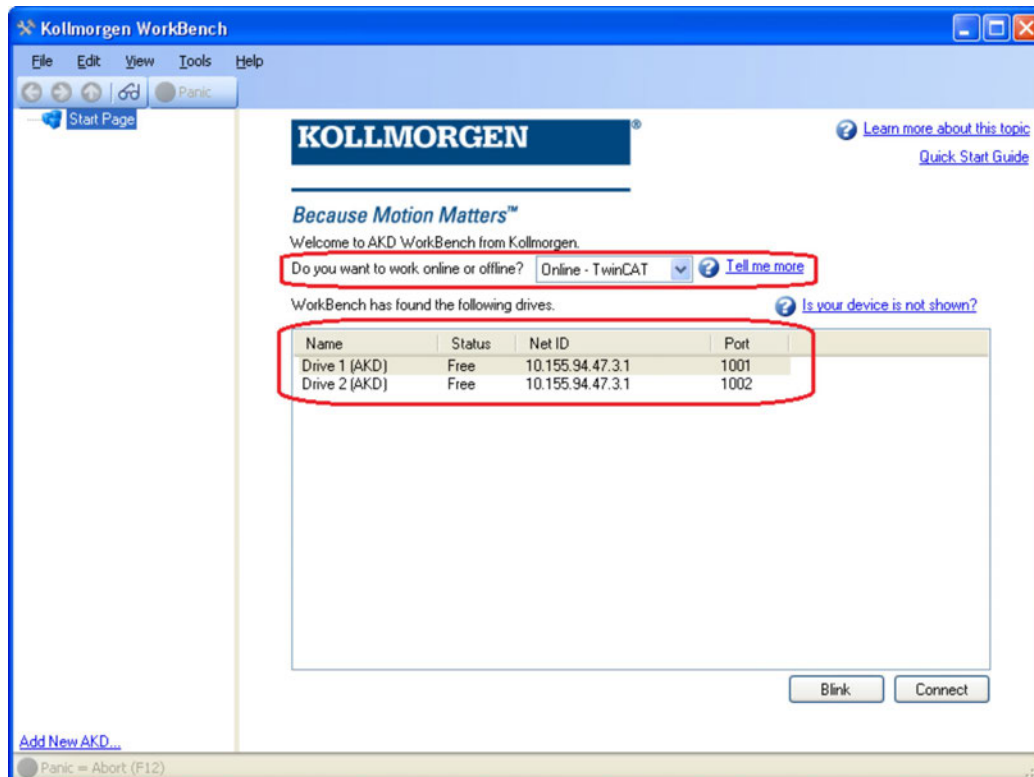

The information provided for a drive are it's name, status, Net ID and Port number. After selecting a drive from the list, clicking on the "Connect" button will create a device in the left frame of WorkBench and connect the device.

The name, Net ID and port number are information coming from the TwinCAT master configuration file (the name may be different than the drive name returned by the *DRV.NAME* command). While the status is an indicator that tells if there is already a device created within WorkBench which is already connected to that particular drive.

Using TwinCAT System Manager, the drive name and port number can be found in the General and EtherCAT tab respectively for the corresponding drive under the I/O Configuration → I/O Devices → Device [x] → Drive [x] node.

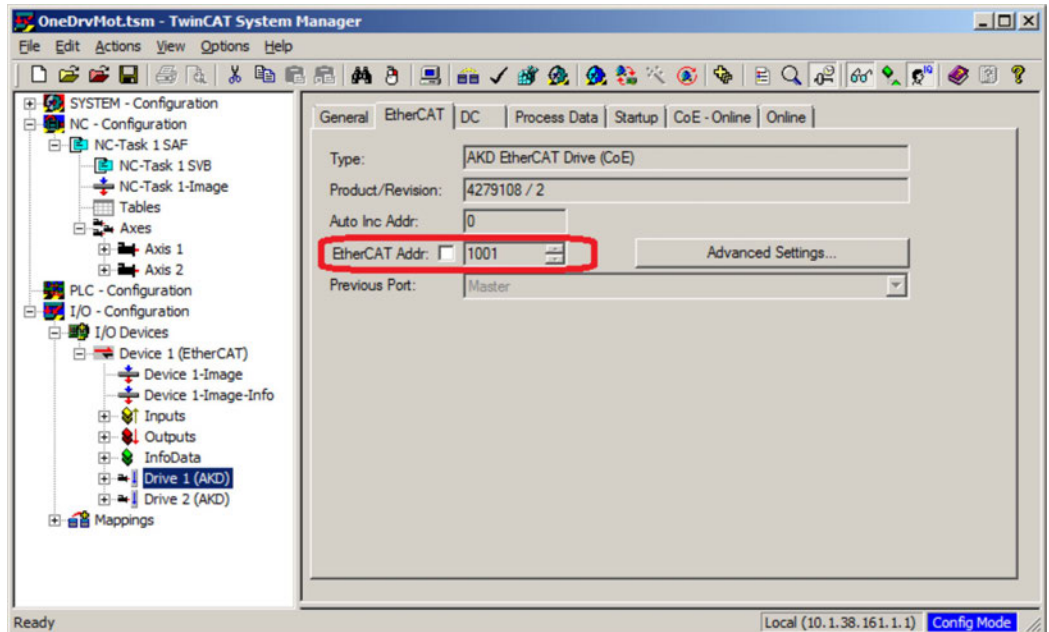
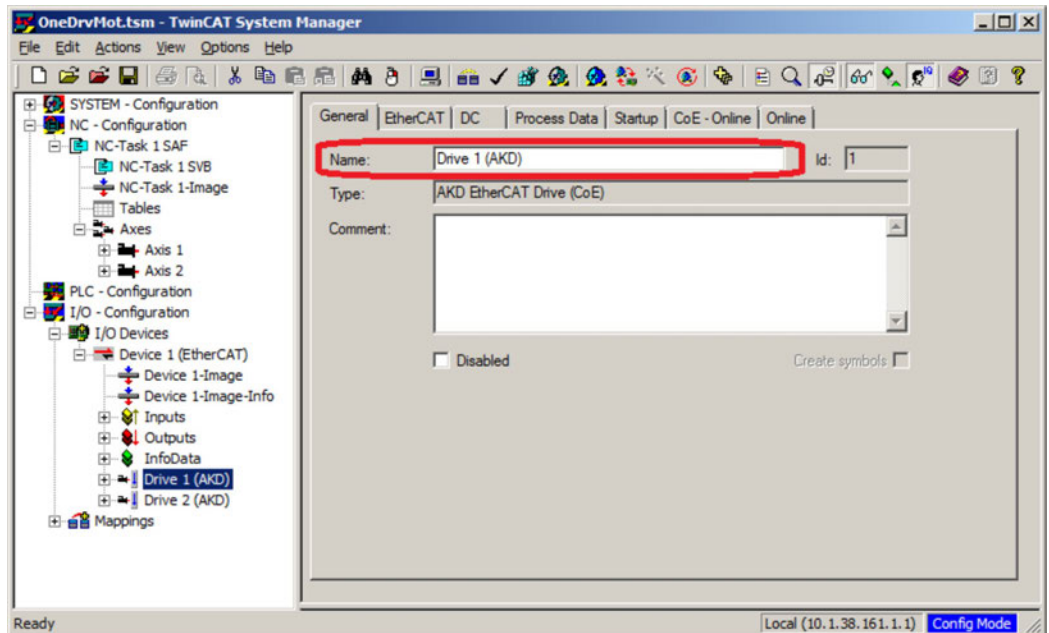

The Net ID can be found in the EtherCAT tab in the I/O Configuration → I/O Devices → Device [x] node.

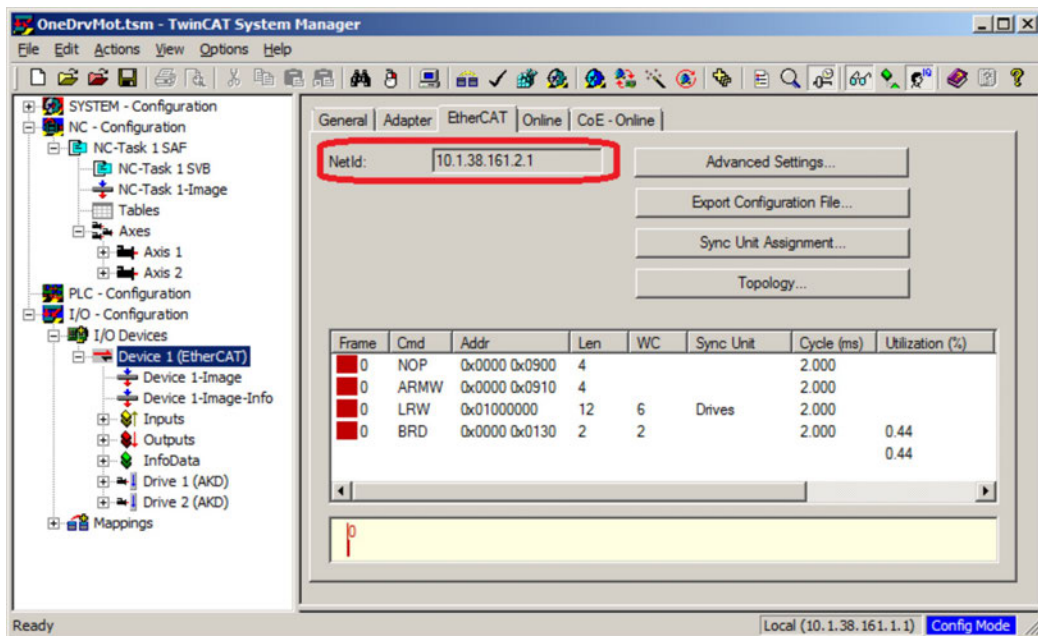

It is important to understand that these information are coming from the TwinCAT master and its configuration file but not from the drive itself. Thus, if the TwinCAT configuration is not reflecting the actual network configuration, you may have a drive listed in WorkBench which is not be powered up or even connected in the EtherCAT network, or you have a drive powered up and connected to the TwinCAT network but not shown in the WorkBench list.

3.5.3 Configuring and enabling a drive

Once connected with WorkBench, a drive can be configured using all normal functionalities of WorkBench.

The only operation that is not possible to do using WorkBench over TwinCAT is the download of a new firmware in the drive. Downloading a new firmware in the drive must be performed using File over EtherCAT (FoE) feature of TwinCAT server.

NOTICE

If the cyclic communication of the TwinCAT master is enabled, it is possible that some commands sent by WorkBench using the ASCII channel are overwritten by the TwinCAT master. Typically, the drive enable command will have no effect if sent from WorkBench because the control word is usually mapped.

Using TwinCAT, enabling the drive can be done with the following procedure:

1. Under NC Configuration → Axes → Axis [x] node, choose the Online tab.
2. Press the Set button within the Enabling section.

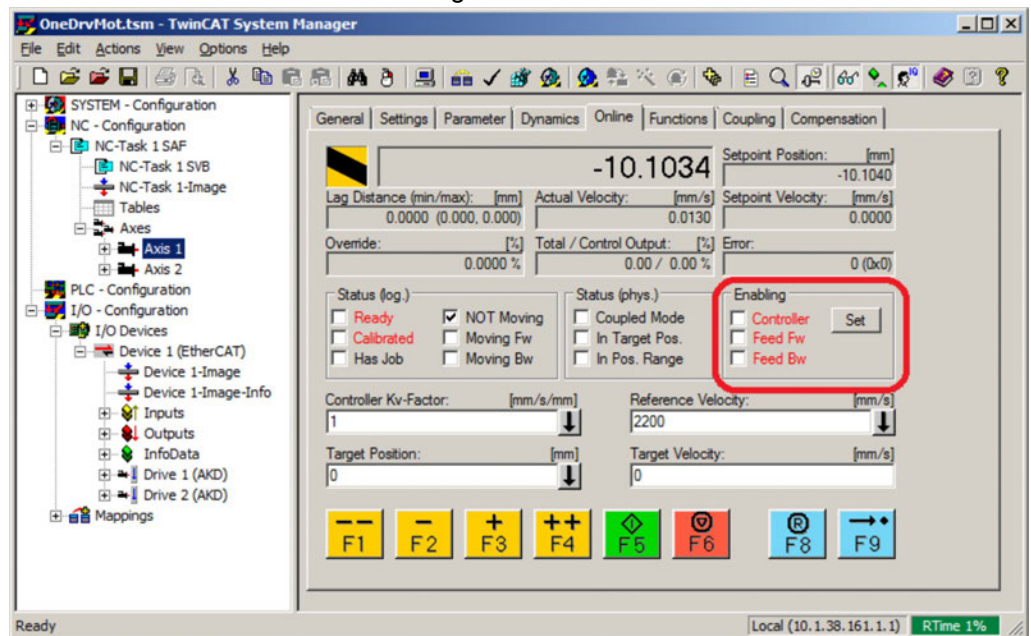

3. In the pop-up dialog box, check the Controller checkbox to enable the drive (or un-check to disable the drive) and press on the OK button.

3.5.4 Download a parameterfile over TwinCAT

You can download a parameter file to the drive over EtherCAT. Before you start, make sure that the drive is in INIT, PREOP, or SAFEOP state before trying to download the file.

1. First select the drive where you want to perform the download.
2. Change to the online tab.

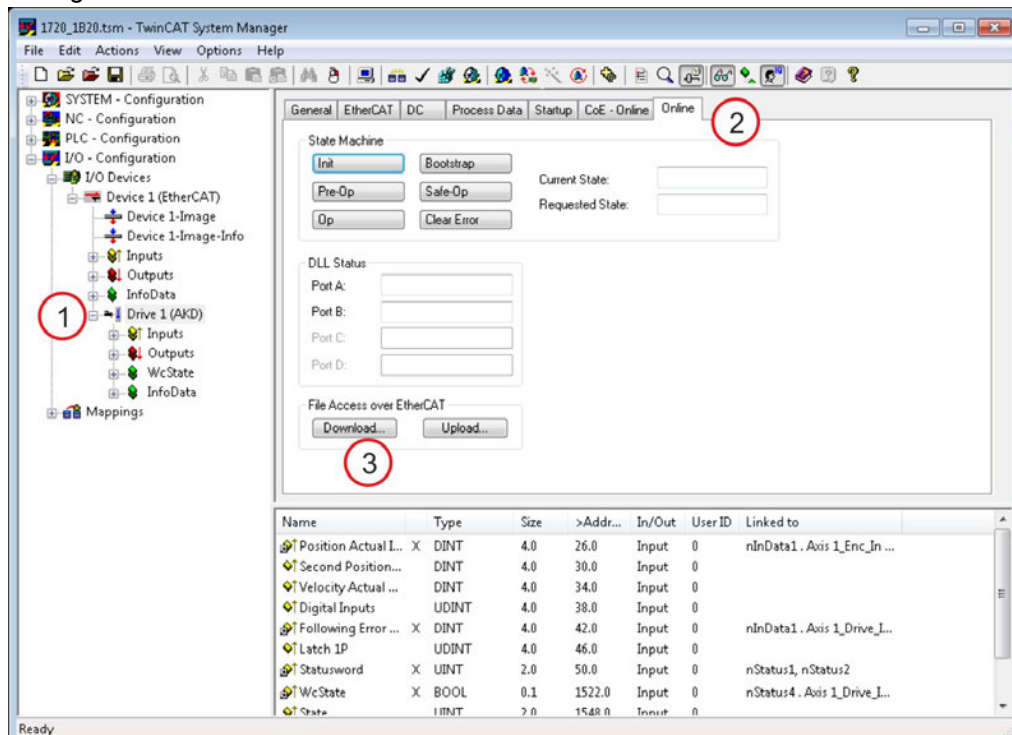

3. Press the download button.
4. Chose "All Files (*.*)" as filetype to see the parameter files which end with ".akd".
5. Select the file.
6. press open (6) to start the download.

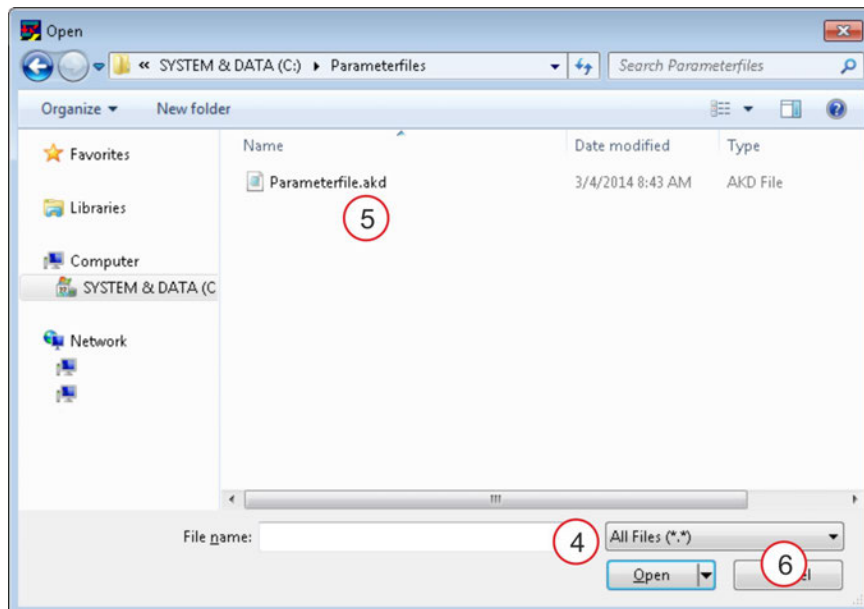

NOTE

Downloading a parameter file over TwinCAT is support by all drives from firmware 01.12.000.

3.6 Setup via KAS IDE

If you are using a Kollmorgen Automation Suite (KAS) system, the AKD setup is completely integrated into the KAS Integrated Development Environment (IDE), as shown below:

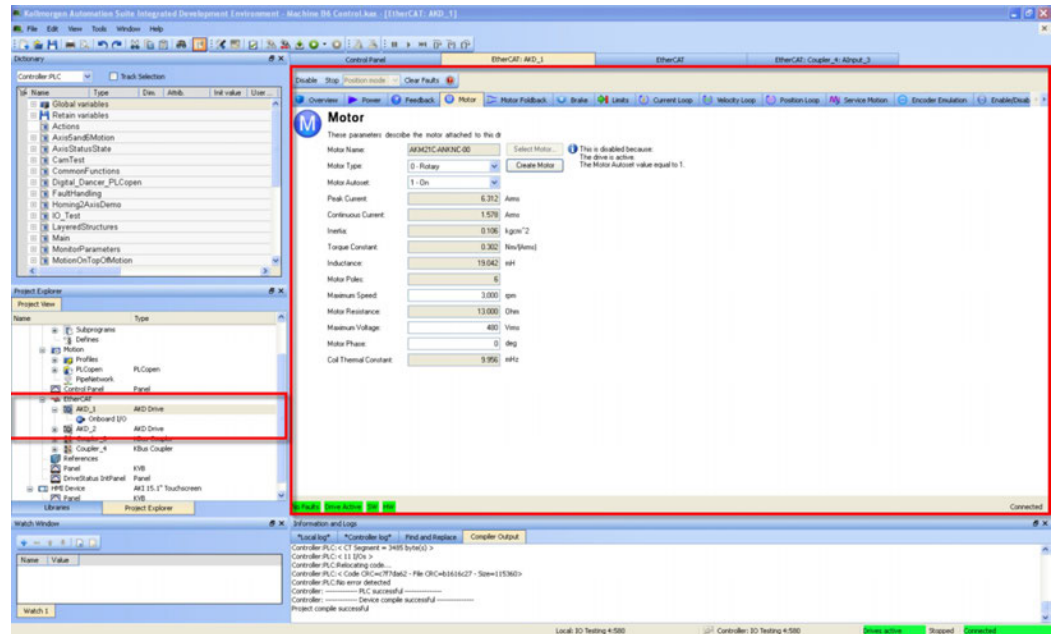

For further information on the setup for a KAS system, see the following sections in the KAS documentation:

- *KAS IDE User Manual*: See section 4.2.3 Add and Configure Drive.
- *KAS Online Help*: See **Using the KAS IDE > Creating a Project > Step 3 - Add and Configure Drive**.

4 EtherCAT Profile

4.1 Slave Register	27
4.2 AL Event (Interrupt Event) and Interrupt Enable	28
4.3 Phase Run-Up	30
4.4 CANopen over EtherCAT (CoE) Status Machine	32
4.5 Fixed PDO Mappings	35
4.6 Flexible PDO Mappings	37
4.7 Supported Cyclical Setpoint and Actual Values	42
4.8 Supported Operation Modes	44
4.9 Adjusting EtherCAT Cycle Time	44
4.10 Maximum Cycle Times depending on operation mode	44
4.11 Synchronization	45
4.12 Latch Control Word and Latch Status Word	46
4.13 Mailbox Handling	47
4.14 Fieldbus Parameters	51
4.15 EEPROM Content	52

4.1 Slave Register

The table below gives the addresses of individual registers in the FPGA memory. The data is provided in little-endian format, with the 'least significant byte' occupying the lowest address. A detailed description of all registers and FPGA memory locations is available in the "EtherCAT Slave Controller" description of the EtherCAT user organization (www.EtherCAT.org).

Address	Length (Byte)	Description	ZA ECAT*	ZA Drive*
0x0120	2	AL Control	R/W	R/O
0x0130	2	AL Status	R/O	R/W
0x0134	2	AL Status Code	R/O	R/W
0x0204	2	Interrupt Enable Register	R/O	R/W
0x0220	2	AL Event (IRQ Event)	R/W	R/O
0x0800	8	Sync Manager 0 (Mail Out Control Register)	R/W	R/O
0x0808	8	Sync Manager 1 (Mail In Control Register)	R/W	R/O
0x0810	8	Sync Manager 2 (Process data Output Control Register)	R/W	R/O
0x0818	8	Sync Manager 3 (Process data Input Control Register)	R/W	R/O
0x0820	8	Sync Manager 4	R/W	R/O
0x0828	8	Sync Manager 5	R/W	R/O
0x0830	8	Sync Manager 6	R/W	R/O
0x0838	8	Sync Manager 7	R/W	R/O
0x0840	8	Sync Manager 8	R/W	R/O
0x1100	Max. 64	ProOut Buffer (Process data Output, set-points ECAT)	R/W	R/O
0x1140	Max. 64	ProIn (Process data Input, act. values ECAT)	R/O	R/W
0x1800	512	Mail Out Buffer (Object Channel Buffer ECAT, byte-length is specified in the device description file)	R/W	R/O
0x1C00	512	Mail In Buffer (Object Channel Buffer Drive, byte-length is specified in the device description file)	R/O	R/W

* ZA ECAT = Access mode EtherCAT

* ZA Drive = Access mode drive

4.2 AL Event (Interrupt Event) and Interrupt Enable

Communication between the drive and the EtherCAT FPGA can be interrupt-driven. The interrupt enable register and the AL event register are responsible for the EtherCAT interface interrupt functionality.

There are two events which lead also to a HW interrupt within the drive, the EEPROM emulation event and the SyncManager 2 event. The actual values of the drive (SyncManager 3 data) are written without any AL event request during each HW IRQ, e.g. triggered by a SyncManager 2 event. The Mailbox exchange between the master and the AKD is completely handled by polling the AL event register within the background task of the drive.

The drive activates individual EtherCAT interface events when the corresponding bit of the interrupt enable register is set to 1. When it is set to 0, the hardware interrupts for the specific events are deactivated.

4.2.1 Interrupt Enable Register (Address 0x0204:0x0205)

Parameter	Address	Bit	ZA Drive	ZA ECAT	Description
AL Control Event	0x204	0	R/W	R/O	Activation of AL control event for phase run-up
-	0x204	1	R/W	R/O	Reserved
Sync0 DC Distributed Clock	0x204	2	R/W	R/O	Activation of distributed clock (DC) sync 0 interrupts for entire communication
Sync1 DC Distributed Clock	0x204	3	R/W	R/O	Activation of distributed clock (DC) sync 1 interrupts for entire communication
SyncManager activation register change	0x204	4	R/W	R/O	Activation of 'SyncManager activation register change' IRQ.
EEPROM emulation event	0x204	5	R/W	R/O	Activation of the EEPROM emulation interrupts.
-	0x204	3 to 7	R/W	R/O	Reserved
Sync Manager 0 Event (Mail Out Event)	0x205	0	R/W	R/O	Activation of output event mailbox (SDO, Sync Manager 0) for object channel.
Sync Manager 1 Event (Mail In Event)	0x205	1	R/W	R/O	Activation of input event mailbox (SDO, Sync Manager 1) for object channel.
Sync Manager 2 Event (Pro Out Event)	0x205	2	R/W	R/O	Activation of output event process data (PDO, card's cyclical setpoints)
Sync Manager 3 Event (Pro In Event)	0x205	3	R/W	R/O	Activation of input event process data (PDO, drive's cyclical actual values)
-	0x205	4 to 7	R/W	R/O	Reserved

4.2.2 AL Event Request (Address 0x0220:0x0221)

When the relevant bit of the AL event request register is set to 1, the EtherCAT interface tells the drive which event it should process by the AKD.

Parameter	Address	Bit	ZA Drive	ZA ECAT	Description
AL Control Event	0x220	0	R/O	R/W	Processing of AL control event for phase run-up
Sync0 Distributed Clock (DC) Event	0x220	2	R/O	R/W	Processing of a distributed clock (DC) event
Sync1 Distributed Clock (DC) Event	0x220	3	R/O	R/W	Processing of a distributed clock (DC) event
SyncManager activation register change	0x220	4	R/O	R/W	The content of the Sync-Manager activation register has been changed.
EEPROM emulation event	0x220	5	R/O	R/W	Processing of an EEPROM emulation event in order to identify the AKD within the network.
-	0x220	6 to 7	R/O	R/W	Reserved
Sync Manager 0 Event	0x221	0	R/O	R/W	Mailbox request (SDO, Sync Manager 0) for object channel.
Sync Manager 1 Event	0x221	1	R/O	R/W	Mailbox response (SDO, Sync Manager 1) for object channel.
Sync Manager 2 Event	0x201	2	R/O	R/W	Process data output (PDO, card's cyclical setpoints)
Sync Manager 3 Event	0x201	3	R/O	R/W	Process data input (PDO, drive's cyclical actual values)
Sync Manager 4 –					
Sync Manager 7 Event	0x221	4 to 7	R/O	R/W	Reserved
Sync Manager 8 –					
Sync Manager 15 Event	0x222	0 to 7	R/O	R/W	Reserved

4.3 Phase Run-Up

The AL control, AL status and AL status code registers are responsible for communication phase run-up (also referred to as EtherCAT status change), for current status display and for any fault messages. The drive responds to every EtherCAT interface transition request made by the AL control register via the AL Status and AL Status Code registers. Any fault messages are displayed in the AL status code register.

A status change within the AL control register is polled within the AKD, which means that an AL control event does not lead to a HW interrupt within the drive.

4.3.1 AL Control (Address 0x0120:0x0121)

Parameter	Address	Bit	ZA Drive	ZA ECAT	Description
Status	0x120	3 to 0	R/O	W/O	0x01: Init Request
0x02: PreOperational Request					
0x03: Bootstrap Mode Request					
0x04: Safe Operational Request					
0x08: Operational Request					
Acknowledgement	0x120	4	R/O	W/O	0x00: No fault acknowledgement 0x01: Fault acknowledgement (positive edge)
Reserved	0x120	7 to 5	R/O	W/O	-
Applic. specific	0x120	15 to 8	R/O	W/O	-

4.3.2 AL Status (Address 0x0130:0x0131)

Parameter	Address	Bit	ZA Drive	ZA ECAT	Description
Status	0x130	3 to 0	W/O	R/O	0x01: Init
0x02: PreOperational					
0x03: Bootstrap Mode					
0x04: Safe Operational					
0x08: Operational					
Status change	0x130	4	W/O	R/O	0x00: Acknowledgement 0x01: Error, e.g. forbidden transition
Reserved	0x130	7 to 5	W/O	R/O	-
Applic. specific	0x130	15 to 8	W/O	R/O	-

4.3.3 AL Status Code (Address 0x0134:0x0135)

Parameter	Address	Bit	ZA Drive	ZA ECAT	Description
Status	0x134	7 to 0	W/O	R/O	See table below
Status	0x135	7 to 0	W/O	R/O	See table below
Code	Description	Current Status (Status change)	Resulting Status		
0x0000	No error	All	Current Status		
0x0011	Invalid requested state change	I -> S, I -> O, P -> O, O -> B, S -> B, P -> B	Current Status + E		
0x0017	Invalid sync manager configuration	I -> P, P -> S	Current Status + E		

No other codes are supported.

4.3.4 EtherCAT communication phases

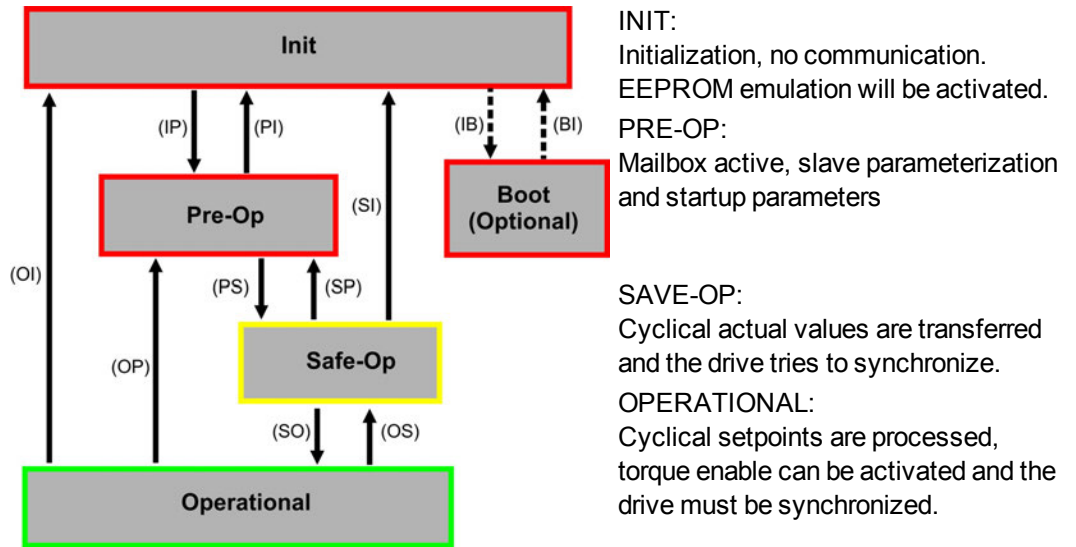

Individual communication transitions

Transition	AL Control (Bit 3 to 0)	Description
(IB)	0x03	-
(BI)	-	-
(IP)	0x02	AKD reads the SyncManager 0 & 1 configuration and verifies the value of the start-address and the length. The AKD prepares itself for handling SyncManager 0 events.
(PI)	0x01	-
(PS)	0x04	AKD reads the SyncManager 2 & 3 configuration and verifies the value of the start-address and the length.
(SP)	0x02	-
(SI)	0x01	-
(SO)	0x08	The SsyncManager 2 hardware interrupt will be enabled by the drive.
(OS)	0x04	Deactivation of SyncManager 2 hardware interrupt.
(OP)	0x02	Deactivation of SyncManager 2 hardware interrupt..
(OI)	0x01	Deactivation of SyncManager 2 hardware interrupt.

4.4 CANopen over EtherCAT (CoE) Status Machine

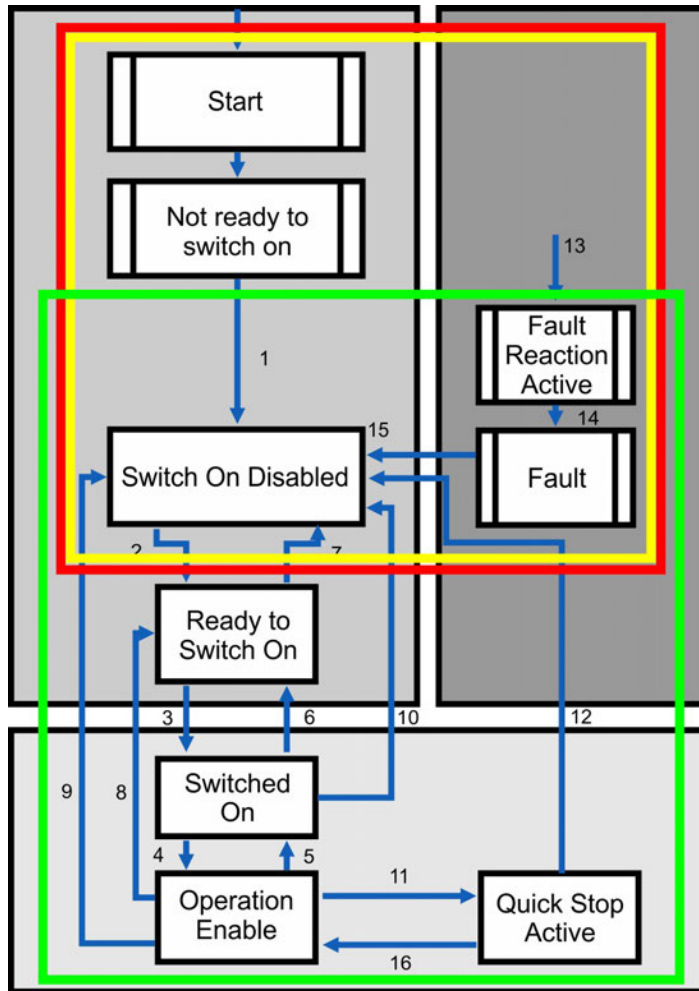

The status machine for the control and status words corresponds to the CANopen status machine in accordance with DS402.

CANopen control and status words are captured in every instance of fixed PDO mapping (see chapter "Fixed PDO Mappings" (→ p. 35)).

4.4.1 Status Description

Status	Description
Not Ready to Switch On	The drive is not ready to switch on; the controller has not indicated readiness for service. The drive is still in the boot phase or in fault status.
Switch On Disable	In 'Switch On Disable' status, the amplifier cannot be enabled via the EtherCAT interface, because (for example) there is no connection to a power source.
Ready to Switch On	In 'Ready to Switch On' status, the drive can be enabled via the control word.
Switched On	In 'Switched On' status, the amplifier is enabled, but the setpoints of the EtherCAT-interface are not yet transferred. The amplifier is idle, and a positive edge in bit 3 of the control word activates setpoint transfer (transition to 'Operation Enable' status).
Operation Enable	In this status, the drive is enabled and setpoints are transferred from the EtherCAT interface.
Quick Stop Active	The drive follows a quick stop ramp.
Fault Reaction Active	The drive responds to a fault with an emergency stop ramp.
Fault	A fault is pending, the drive is stopped and disabled.

4.4.2 Commands in the Control Word

Bit assignment in the control word

Bit	Name	Bit	Name
0	Switch on	8	Pause/halt
1	Disable Voltage	9	reserved
2	Quick Stop	10	reserved
3	Enable Operation	11	reserved
4	Operation mode specific	12	reserved
5	Operation mode specific	13	Manufacturer-specific
6	Operation mode specific	14	Manufacturer-specific
7	Reset Fault (only effective for faults)	15	Manufacturer-specific

Commands in the control word

Command	Bit 7 Fault Reset	Bit 3 Enable Oper- ation	Bit 2 Quick Stop	Bit 1 Disable Voltage	Bit 0 Switch On	Transitions
Shutdown	X	X	1	1	0	2, 6, 8
Switch on	X	X	1	1	1	3
Disable Voltage	X	X	X	0	X	7, 9, 10, 12
Quick Stop	X	X	0	1	X	7, 10, 11
Disable Operation	X	0	1	1	1	5
Enable Operation	X	1	1	1	1	4, 16
Fault Reset	1	X	X	X	X	15

Bits labeled **X** are irrelevant. **0** and **1** indicate the status of individual bits.

Mode-dependent bits in the control word

The following table shows the mode-dependent bits in the control word. Only manufacturer-specific modes are supported at present. The individual modes are set by Object 6060h Modes of operation.

Operation mode	No	Bit 4	Bit 5	Bit 6
Profile Position Mode (pp)	01h	new_setpoint	change_set_ immediately	absolute/relative
Profile Velocity Mode (pv)	03h	reserved	reserved	reserved
Profile Torque Mode (tq)	04h	reserved	reserved	reserved
Homing Mode (hm)	06h	homing_operation_ start	reserved	reserved
Interpolated Position Mode (ip)	07h		reserved	reserved
Cyclic synchronous position mode	08h	reserved	reserved	reserved

Description of the remaining bits in the control word

Bit 8: (Pause) If Bit 8 is set, then the drive halts (pauses) in all modes. The setpoints (speed for homing or jogging, motion task number, setpoints for digital mode) for the individual modes are retained.

Bit 9,10: These bits are reserved for the drive profile (DS402).

Bit 13, 14, 15: These bits are manufacturer-specific, and reserved at present.

4.4.3 Status Machine Bits (status word)

Bit assignment in the status word

Bit	Name	Bit	Name
0	Ready to switch on	8	Manufacturer-specific (reserved)
1	Switched on	9	Remote (always 1)
2	Operation enable	10	Target reached
3	Fault	11	Internal limit active
4	Voltage enabled	12	Operation mode specific (reserved)
5	Quick stop	13	Operation mode specific (reserved)
6	Switch on disabled	14	Manufacturer-specific (reserved)
7	Warning	15	Manufacturer-specific (reserved)

States of the status machine

State	Bit 6 switch on disable	Bit 5 quick stop	Bit 3 fault	Bit 2 operation enable	Bit 1 switched on	Bit 0 ready to switch on
Not ready to switch on	0	X	0	0	0	0
Switch on disabled	1	X	0	0	0	0
Ready to switch on	0	1	0	0	0	1
Switched on	0	1	0	0	1	1
Operation enabled	0	1	0	1	1	1
Fault	0	X	1	0	0	0
Fault reaction active	0	X	1	1	1	1
Quick stop active	0	0	0	1	1	1

Bits labeled **X** are irrelevant. **0** and **1** indicate the status of individual bits.

Description of the remaining bits in the status word

Bit 4: voltage_enabled The DC-link voltage is present if this bit is set.

Bit 7: warning There are several possible reasons for Bit 7 being set and this warning being produced. The reason for this warning can be revealed by using the Object 20subindex manufacturer warnings.

Bit 9: remote is always set to 1, i.e. the drive can always communicate and be influenced via the RS232 - interface.

Bit 10: target_reached This is set when the drive has reached the target position.

Bit 11: internal_limit_active This bit specifies that a movement was or is limited. In different modes, different warnings cause the bit to be set.

4.5 Fixed PDO Mappings

Various ready-to-use mappings can be selected for cyclic data exchange via SDO's of the object 0x1C12 and 0x1C13. Using object 0x1C12 subindex 1 (Sync Manager 2 assignment), a fixed mapping for the cyclic command values can be set with the values 0x1701, 0x1702, 0x1720 to 0x1724. Using object 0x1C13 subindex 1 (Sync Manager 3 assignment), a fixed mapping for the cyclic actual values can be set via the data 0x1B01, 0x1B20 to 0x1B25.

Use the sequence below to select the fixed command value mapping 0x1701 via SDO's:

1. SDO write access to object 0x1C12Sub0 Data:0x00
2. SDO write access to object 0x1C12Sub1 Data:0x1701
3. SDO write access to object 0x1C12Sub0 Data:0x01

NOTE

Up to firmware version 1.8.x.x AKD.XML file, fixed mapping 0x1701 called out 0x6062sub0 as the "Position Command". From AKD firmware release 1.8.5.0, the AKD.XML will be changed to call out 0x60C1sub1 as the "Position Command" and an additional XML file called "AKD_TwinCAT.XML" will be added to support TwinCat 2x and older. In reality, SDO 0x6062sub0 is not supported in the AKD firmware but was called in the fixed mapping to support a TwinCat issue.

Position interface, supported fixed mappings:

0x1701	Position command value (4 bytes), Control word (2 bytes), total (6 bytes)
0x1720	Control Word (2 bytes), Interpolated position command value (4 bytes), Latch control word (2 bytes), Torque feed forward (2 bytes), Digital outputs (2 bytes)
0x1721	Interpolated position command value (4 bytes), Control Word (2 bytes), Torque feed forward (2 bytes)
0x1722	Control word (2 byte), Interpolated position command value (4 bytes), Latch control word (2 bytes), Torque feed forward (2 bytes), Digital outputs (2 bytes), max. torque (2 bytes)
0x1723	Control word (2 bytes), Interpolated position command value (4 bytes), Latch control word (2 bytes), Torque feed forward (2 bytes), Digital outputs (2 bytes), Reset of changed input information (2 bytes)
0x1724	Target position for cyclic synchronous position mode (4 bytes), Control word (2 byte), Torque feed forward (2 bytes)
0x1B01	Position actual value (4 bytes), Status word (2 bytes), total (6 bytes)
0x1B20	Position actual internal value (4 bytes), 2nd position feedback position (4 bytes), velocity actual value (4 bytes), digital inputs (4 bytes), following error (4 bytes), latch position positive (4 bytes), status word (2 bytes), torque actual value (2 bytes), latch status (2 bytes), analogue input value (2 bytes)
0x1B21	Position Actual Internal Value (4 bytes), Status word (2 bytes)
0x1B22	Position actual internal value (4 bytes), 2nd position feedback position (4 bytes), velocity actual value (4 bytes), digital inputs (4 bytes), following error (4 bytes), latch position negative (4 bytes), status word (2 bytes), torque actual value (2 bytes), latch status (2 bytes), analogue input value (2 bytes)
0x1B23	Position actual internal value (4 bytes), 2nd position feedback position (4 bytes), velocity actual value (4 bytes), digital inputs (4 bytes), following error (4 bytes), latch position positive / negative (4 bytes), status word (2 bytes), torque actual value (2 bytes), latch status (2 bytes), analogue input value (2 bytes)
0x1B24	Position actual value (4 bytes), status word (2 bytes)
0x1B25	Position actual internal value (4 bytes), 2nd position feedback position (4 bytes), latch position 2 positive / negative (4 bytes), digital inputs (4 bytes), following error (4 bytes), latch position 1 positive / negative (4 bytes), status word (2 bytes), torque actual value (2 bytes), latch status (2 bytes), analogue input value (2 bytes)

Velocity interface, supported fixed mappings:

0x1702	Velocity command value (4 bytes), Control word (2 bytes), total (6 bytes)
--------	---

The objects, which are mapped into the fixed PDOs can be read via the subindices 1 to n of the above indices. The number of mapped entries is available by reading subindex 0 of the above indices.

Example:

A read access to object 1702 sub 0 gives a value of 2, a read on subindex 1 gives 0x60ff0020, on subindex 2 0x60400010. The meaning of these numbers can be seen in the CANopen manual or the flexible-mapping example (→ p. 39.).

4.6 Flexible PDO Mappings

In addition to the fixed PDO mapping the so-called flexible mapping of real-time objects is possible.

NOTE

Available objects for PDO mapping are listed in the object dictionaries ("Appendix" (→ p. 53)). All objects with the entry "yes" in column "PDO map." can be used.

Restrictions of flexible mapping:

- An odd length PDO is not allowed.
 - In the Rx(=set-point)-direction the dummy-object 0x0002 sub 0 with a length of 8 bits can be used to make the PDO-length even.
 - In the Tx(=actual value)-direction one sub-index of the manufacturer status object 0x2002 sub 1..4 can be used to guarantee the even length of the Tx-PDO.
 - These special mappings may be used if the objects 0x6060 and 0x6061 have to be used in the mapping.
- The allowed PDOs have up to 32 bytes (Tx) or 22 bytes (Rx). They are built from smaller PDO modules with a maximum length of 8 bytes. These are built by using the mapping objects 0x1600 to 0x1603 and 0x1a00 to 0x1a03.

The configuration is similar to the described sequence for the fixed mappings:

1. The mapping selection is cleared (write 0 to object 0x1C12 sub 0 and 1C13 sub 0)
2. As the AKD - implementation is based on CANopen the real-time data are build from up to 4 PDOs with 8 bytes in both directions. These PDOs are built in the same way as in a CAN-drive with the objects 0x1600 - 0x1603 and 0x1A00 - 0x1A03. Unused PDOs must be cleared with writing 0 to the subindex 0.
3. SDO write access to object 0x1C12 sub 1 .. 4 with the PDOs (0x1600 .. 0x1603), that should be used in receive direction of the AKD (set point values).
4. SDO write access to object 0x1C13 sub 1 .. 4 with the PDOs (0x1A00 .. 0x1A03), that should be used in transmit direction of the AKD (actual values).
5. SDO write access to the objects 0x1C12 sub 0 and 0x1C13 sub 0 with the number of mapped PDOs in this direction.

See an example in chapter "Flexible PDO Mappings" (→ p. 37).

The cyclically used data are visible in the PDO-assignment window for the Inputs and Outputs of the Sync Managers. Default setting are the fixed PDOs 0x1701 and 0x1B01 (visible contents when selected in the PDO list).

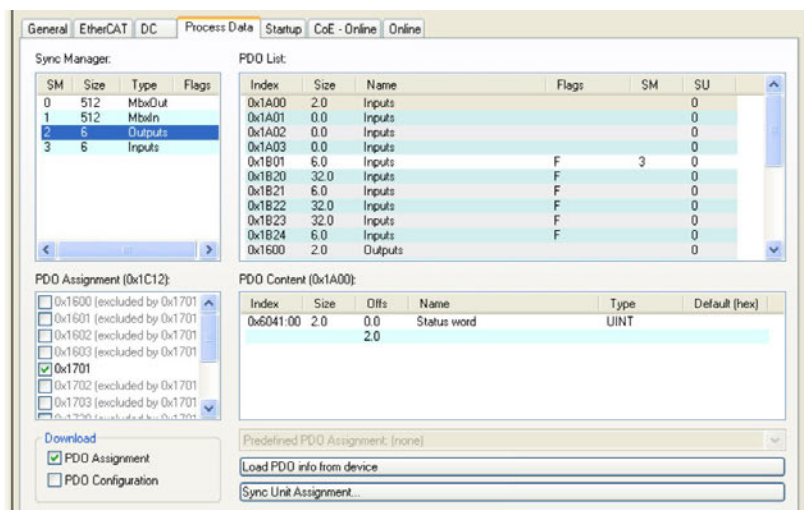

If the flexible mapping is required, the PDO configuration check box must be changed.

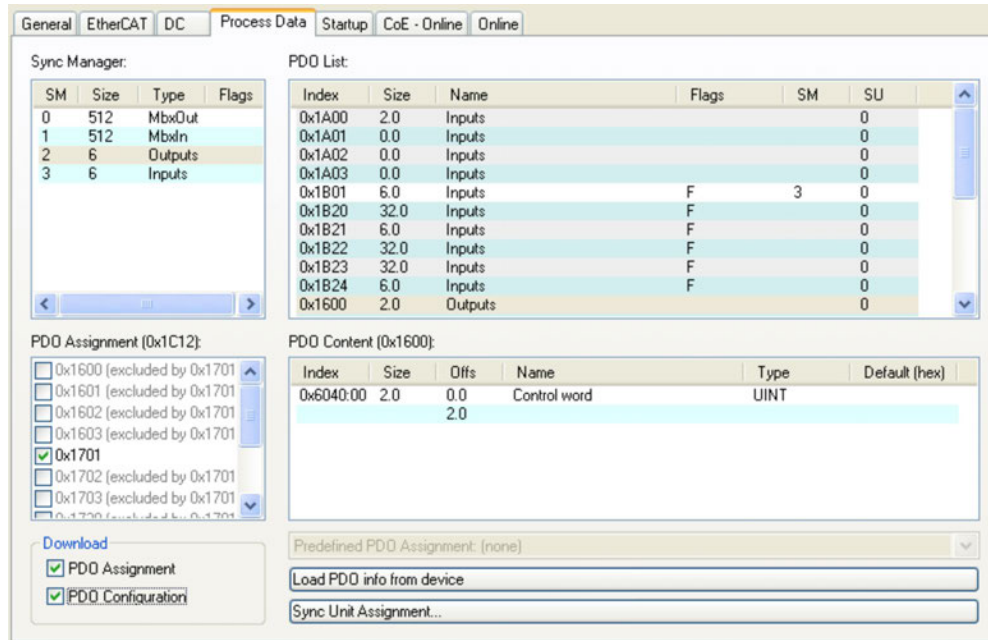

4.6.1 Example: Flexible PDO Mapping

For the flexible mapping of the Outputs the fixed mapping 0x1701 has to be switched off and up to 4 free-mappable PDOs (0x1600-0x1603) can be used instead. The maximum number of bytes for each of these PDOs is 8.



After that the default mapping of e.g. the PDO 0x1600 can be extended:

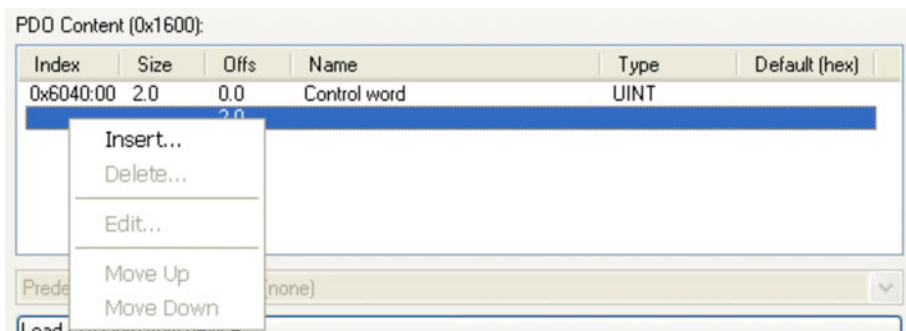

A list of possible objects for the mapping will be shown and a new entry can be chosen.

Edit Pdo Entry

Name:

Index (hex):

Sub Index:

Data Type:

Bit Length:

From Dictionary:

- 0x20A0 - Latch1P32
- 0x20A1 - Latch1N32
- 0x20A2 - Latch2P32
- 0x20A3 - Latch2N32
- 0x20A4 - LatchControl
- 0x20A5 - LatchStatus
- 0x20A6 - Latch1pn
- 0x20B8 - ClearDigInpuChangedBit
- 0x35FC - reserved
- 0x6040 - Controlword
- 0x6041 - Statusword
- 0x6042 - reserved
- 0x6044 - reserved
- 0x6060 - Modes of Operation
- 0x6061 - Modes of Operation Display

In this case the setpoint for the interpolated position mode is selected.

Edit Pdo Entry

Name:

Index (hex):

Sub Index:

Data Type:

Bit Length:

From Dictionary:

- 0x1002 - Manufacturer Status Register
- 0x2050 - DRV_HANDWHEEL
- 0x20A0 - Latch1P32
- 0x20A1 - Latch1N32
- 0x20A2 - Latch2P32
- 0x20A3 - Latch2N32
- 0x20A4 - LatchControl
- 0x20A5 - LatchStatus
- 0x20A6 - Latch1pn
- 0x20B8 - ClearDigInpuChangedBit
- 0x35FC - reserved
- 0x6040 - Controlword
- 0x6041 - Statusword
- 0x6042 - reserved
- 0x6044 - reserved

The same is valid for the Tx-PDO-direction. Here the value of the actual internal position is selected.

This results in the startup-SDO-list for this sample free-mapped-configuration.

Transition	Protocol	Index	Data	Comment
<PS>	CoE	0x1C12:00	0x00 (0)	clear sm pdos (0x1C12)
<PS>	CoE	0x1C13:00	0x00 (0)	clear sm pdos (0x1C13)
<PS>	CoE	0x1A00:00	0x00 (0)	clear pdo 0x1A00 entries
<PS>	CoE	0x1A00:01	0x60410010 (1614872592)	download pdo 0x1A00 entry
<PS>	CoE	0x1A00:02	0x60630020 (1617100832)	download pdo 0x1A00 entry
<PS>	CoE	0x1A00:00	0x02 (2)	download pdo 0x1A00 entr...
<PS>	CoE	0x1A01:00	0x00 (0)	clear pdo 0x1A01 entries
<PS>	CoE	0x1A02:00	0x00 (0)	clear pdo 0x1A02 entries
<PS>	CoE	0x1A03:00	0x00 (0)	clear pdo 0x1A03 entries
<PS>	CoE	0x1600:00	0x00 (0)	clear pdo 0x1600 entries
<PS>	CoE	0x1600:01	0x60400010 (1614807056)	download pdo 0x1600 entry
<PS>	CoE	0x1600:02	0x60C10120 (1623261472)	download pdo 0x1600 entry
<PS>	CoE	0x1600:00	0x02 (2)	download pdo 0x1600 entr...
<PS>	CoE	0x1601:00	0x00 (0)	clear pdo 0x1601 entries
<PS>	CoE	0x1602:00	0x00 (0)	clear pdo 0x1602 entries
<PS>	CoE	0x1603:00	0x00 (0)	clear pdo 0x1603 entries
<PS>	CoE	0x1C12:01	0x1600 (5632)	download pdo 0x1C12:01 i...
<PS>	CoE	0x1C12:00	0x01 (1)	download pdo 0x1C12 count
<PS>	CoE	0x1C13:01	0x1B01 (6913)	download pdo 0x1C13:01 i...
<PS>	CoE	0x1C13:00	0x01 (1)	download pdo 0x1C13 count
PS	CoE	0x6060:00	0x07 (7)	Opmode
PS	CoE	0x60C2:01	0x02 (2)	Cycle time
PS	CoE	0x60C2:02	0xFD (253)	Cycle exp

The meaning of the data (for example 0x60410010 in the mapping of 0x1A00 sub 1) is as follows:

- 0x6041 is the index of the DS402 status word
- 0x00 is the subindex of the DS402 status word
- 0x10 is the number of bits for this entry, i. e. 16 bits or 2 bytes.

If this shall be used in the NC, the interpolation set point position has to be linked from the axis to the NC-axis.

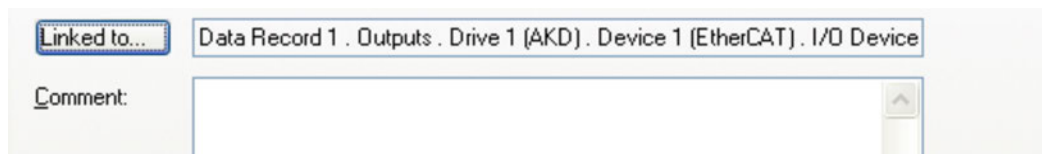
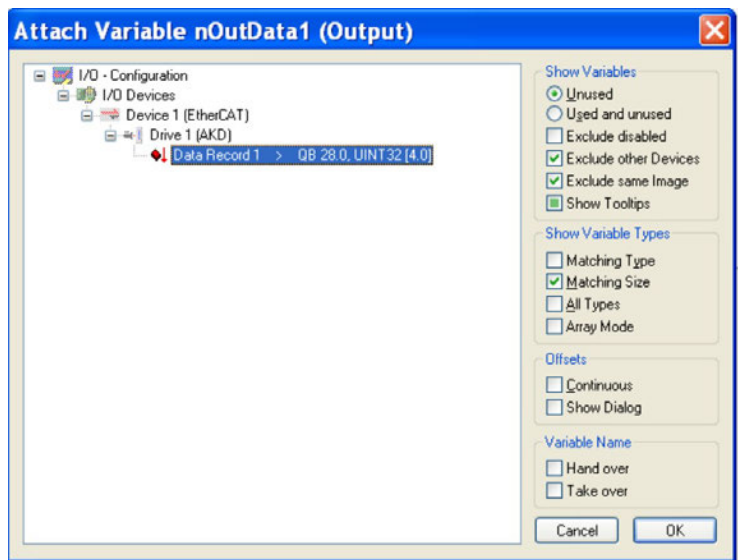
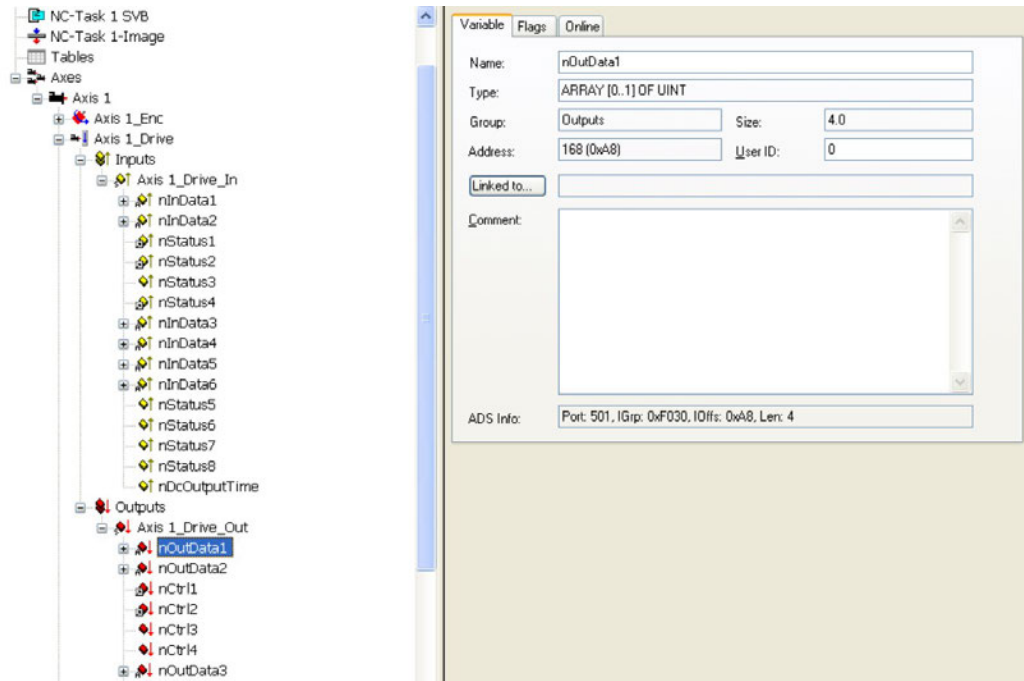

After doing this configuration the mapping can be activated as seen before in this document:

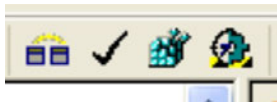

Now the NC-screen should show a position in the online window, which changes a bit in the last digits.

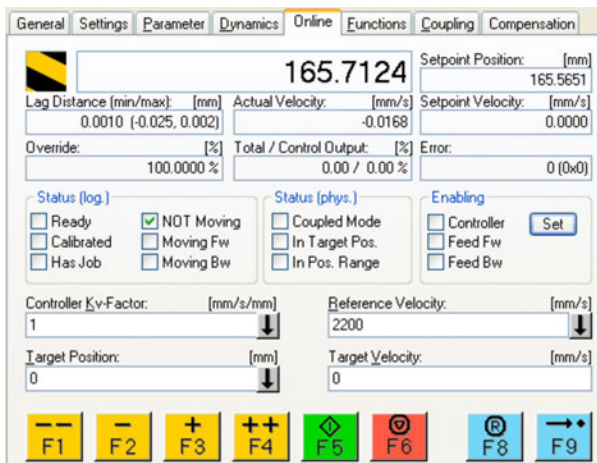

After enabling the power stage with the All-button, the drive can be moved via the jog-buttons or via the functions in the function menu.

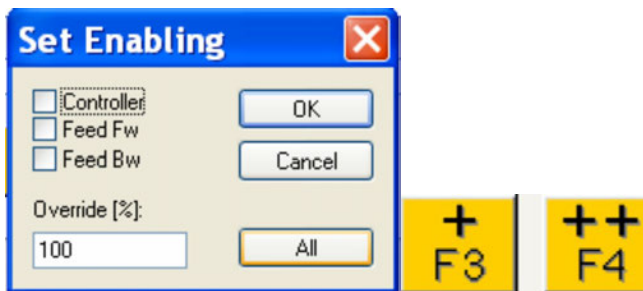

4.7 Supported Cyclical Setpoint and Actual Values

Supported cyclical setpoint values

Name	CANopen object	Data type	Description
Position command value	0x60C1 sub 1	INT32	Interpolation data record in IP-mode
Velocity command value	0x60FF sub 0	INT32	
CANopen control-word	0x6040 sub 0	UINT16	CANopen control word.
Latch Control word	0x20A4 sub 0	UINT16	
Torque feed forward	0x60B2 sub 0	INT16	
Digital outputs	0x60FE sub 1	UINT32	
Target current	0x2071 sub 0	32 bit	scaled in mA
Modes of Operation	0x6060 sub 0	8 bit	DS402 opmode setpoint
Velocity Window	0x606D sub 0	16 bit	
Velocity Window Time	0x606E sub 0	16 bit	
Target Torque	0x6071 sub 0	16 bit	0.1% resolution
Maximum Torque	0x6072 sub 0	16 bit	
Profile position target velocity	0x6081 sub 0	32 bit	MT.V
Profile position target acc	0x6083 sub 0	32 bit	MT.ACC
Profile position target dec	0x6084 sub 0	32 bit	MT.DEC
Velocity feed forward	0x60B1 sub 0	32 bit	
Touch probe function	0x60B8	16 bit	
Analog output value	0x3470 sub 3	16 bit	
External feedback position	0x3497 sub 0	32 bit	
Clear digital Input Change Bit	0x20B8	16 bit	

Supported cyclical actual values

Name	CANopen object	Data type	Description
Position actual internal value	0x6063 sub 0	INT32	
Velocity actual value	0x606C sub 0	INT32	
CANopen status-word	0x6041 sub 0	UINT16	CANopen status word
Second position feedback	0x2050 sub 0	INT32	
Digital inputs	0x60FD sub 0	UINT32	
Following error actual value	0x60F4 sub 0	INT32	
Latch position positive edge	0x20A0 sub 0	INT32	
Torque actual value	0x6077 sub 0	INT16	
Latch status	0x20A5 sub 0	UINT16	
Analog input value	0x3470 sub 0	INT16	
Actual Current	0x2077 sub 0	32 bit	scaled in mA
Latch1 negative edge	0x20A1 sub 0	32 bit	
Latch2 Positive	0x20A2 sub 0	32 bit	
Latch2 Negative	0x20A3 sub 0	32 bit	
Latch1 positive/negative edge	0x20A6	32 bit	
Latch 2 positive/negative edge	0x20A7	32 bit	
Modes of Operation	0x6061	8 bit	DS402 opmode status
Position Actual Value	0x6064 sub 0	32 bit	WB/ DS402 scale units
Touch probe status	0x60B9 sub 0	16 bit	
Touch probe 1 positive edge pos	0x60BA sub 0	32 bit	
Touch probe 1 negative edge pos	0x60BB sub 0	32 bit	
Touch probe 2 positive edge pos	0x60BC sub 0	32 bit	
Touch probe 2 negative edge pos	0x60BD sub 0	32 bit	
Additional Pos actual value	0x60E4 sub 0	48 bit	
Additional Pos actual value	0x60E4 sub 1	32 bit	
Motor I2t	0x3427 sub 3	32 bit	
Analog output value	0x3470 sub 2	16 bit	
Analog Input & Output value	0x3470 sub 4	16 bit	
Manufacturer status register	0x1002 sub 0	32 bit	

4.8 Supported Operation Modes

CANopen mode of operation	AKD mode of operation	Description
Profile velocity	DRV.OPMODE 1 DRV.CMDSOURCE 1	0x6060Sub0 Data: 3 In this mode, the EtherCAT master sends cyclic velocity command values to the AKD.
Interpolated position	DRV.OPMODE 2 DRV.CMDSOURCE 1	0x6060Sub0 Data: 7 In this mode of operation the EtherCAT master sends cyclic position command values to the AKD. These command values are interpolated by the AKD according to the fieldbus sample rate.
Homing mode	DRV.OPMODE 2 DRV.CMDSOURCE 0	0x6060 sub 0 data : 6 In this mode an AKD-internal homing can be done.
Profile Position	DRV.OPMODE 2 DRV.CMDSOURCE 0	0x6060sub0 Data: 1 Uses motion task 0 to execute a point to point move
Torque	DRV.OPMODE 0 DRV.CMDSOURCE 1	0x6060sub0 Data: 4 Commands torque in % of drive peak torque
Cyclic Synchronous Position	DRV.OPMODE 2 DRV.CMDSOURCE 1	0x6060sub0 Data: 8 Master calculates move profile and commands motion with position points

4.9 Adjusting EtherCAT Cycle Time

The cycle time to be used in the drive for the cyclical setpoints and actual values can either be stored in the FBUS.SAMPLEPERIOD parameter in the amplifier or configured in the startup phase. This happens via SDO mailbox access to objects 60C2 subindex 1 and 2.

Subindex 2, known as the interpolation time index, defines the power of ten of the time value (e.g. -3 means 10⁻³ or milliseconds) while subindex 1, known as interpolation time units, gives the number of units (e.g. 4 means 4 units).

You can run a 2 ms cycle using various combinations. For example,

Index = -3, Units = 2 or

Index = -4, Units = 20 etc.

The FBUS.SAMPLEPERIOD parameter is counted in multiples of 62.5us microseconds within the device. This means, for example that 2 ms equates to FBUS.SAMPLEPERIOD value of 32.

4.10 Maximum Cycle Times depending on operation mode

The minimum cycle time for the drive is largely dependent on the drive configuration (second actual position value encoder latch functionality enabled and so on)

Interface	Cycle time AKD
Position	≥ 0.25 ms (≥ 250 μs)
Velocity	≥ 0.25 ms (≥ 250 μs)
Torque	≥ 0.25 ms (≥ 250 μs)

4.11 Synchronization

On all drives, the internal PLL is theoretically able to even out an average deviation of up to 4800 ppm in the cycle time provided by the master. The drive checks once per fieldbus cycle a counter within the drive internal FPGA, which is cleared by a Sync0 (Distributed clock) event. Depending of the counter value, the drive extends or decreases the 62.5 μ s MTS signal within the drive by a maximum of 300 ns.

The theoretical maximum allowed deviation can be calculated by using the following formula:

$$\max_{dev} = \frac{300[\text{ns}]}{62.5[\mu\text{s}]} \cdot 1,000,000 = 4800 \text{ [ppm]}$$

The synchronization functionality within the drive can be enabled via setting bit 0 of the FBUS.PARAM02 parameter to high. Therefore FBUS.PARAM02 must be set to the value of 1. Furthermore the distributed clock functionality must be enabled by the EtherCAT master in order to activate cyclic Sync0 events.

4.11.1 Synchronization behavior with distributed clocks (DC) enabled

When the EtherCAT master enables distributed clocks, a distributed clock (DC) event is created in the AKD once per fieldbus cycle. An assigned 62.5 μ s real-time task in the AKD monitors the elapsed time between the DC events and the AKD System time and extends or reduces the 62.5 μ s strobe to the CPU as necessary.

The following fieldbus parameters are used for the synchronization feature:

1. FBUS.SYNCDIST = Expected time delay of the AKD PLL-code to the DC event.
2. FBUS.SYNCACT = Actual time delay of the AKD PLL-code to the DC event.
3. FBUS.PLLTHRESH = Number of consecutive successful synchronized PLL cycles of the AKD before the Drive is considered as synchronized.
4. FBUS.SYNCWND = Synchronization window in which the AKD is considered to be synchronized. The Drive is considered synchronized as long as the following statement is true is true for FBUS.PLLTHRESH consecutive cycles:

$$\text{FBUS.SYNCDIST} - \text{FBUS.SYNCWND} < \text{FBUS.SYNCACT} < \text{FBUS.SYNCDIST} + \text{FBUS.SYNCWND}$$

Example with a 4kHz fieldbus sample rate:

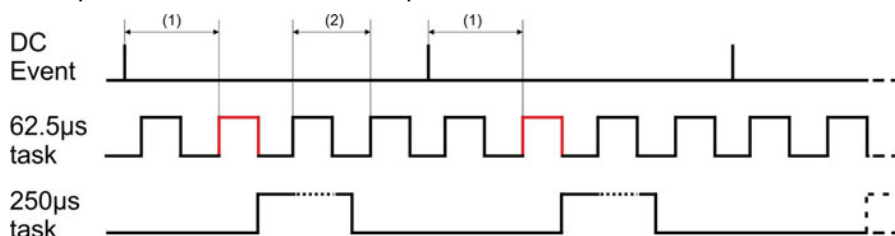

Explanation: The red-marked 62.5 μ s real-time task displays the AKD 62.5 μ s real-time task within one fieldbus cycle which is responsible for calling the AKD PLL-code. The time delay (1) shows the actual delay to the previous DC event, which is ideally close to the adjusted FBUS.SYNCDIST parameter. Depending on (1) the AKD slightly extends or reduce the 62.5 μ s [μ s] IRQ generation of the high-priority real-time task in order to either increase or decrease the measured time delay to the DC event (1) for the next PLL cycle. The time distance (2) shows the 62.5 μ s \pm x [ms] realtime task of the AKD.

4.11.2 Synchronization behavior with distributed clocks (DC) disabled

The AKD fieldbus synchronization algorithm is similar to that used by Distributed Clocks. The difference is that the AKD synchronizes to a SyncManager2 event instead of the DC event. A SyncManager2 event is created when the EtherCAT Master sends a new package of command values to the drive while the network is in the Operational state. This occurs once per fieldbus cycle.

4.12 Latch Control Word and Latch Status Word

Latch Control word (2 Byte)

Bit	Value (bin)	Value (hex)	Description
0	00000000 00000001	zz01	Enable extern latch 1 (positive rise)
1	00000000 00000010	zz02	Enable extern latch 1 (negative rise)
2	00000000 00000100	zz04	Enable extern latch 2 (positive rise)
3	00000000 00001000	zz08	Enable extern latch 2 (negative rise)
4			
5-7			Reserve
8-12	00000001 00000000	01zz	Read external latch 1 (positive rise)
	00000010 00000000	02zz	Read external latch 1 (negative rise)
	00000011 00000000	03zz	Read external latch 2 (positive rise)
	00000100 00000000	04zz	Read external latch 2 (negative rise)
13-15			Reserve

Latch Status word (2 Byte)

Bit	Value (bin)	Value (hex)	Description
0	00000000 00000001	zz01	External latch 1 valid (positive rise)
1	00000000 00000010	zz02	External latch 1 valid (negative rise)
2	00000000 00000100	zz04	External latch 2 valid (positive rise)
3	00000000 00001000	zz08	External latch 2 valid (negative rise)
4			
5-7			Reserve
8-11	00000001 00000000	z1zz	Acknowledge value external latch 1 (positive rise)
	00000010 00000000	z2zz	Acknowledge value external latch 1 (negative rise)
	00000011 00000000	z3zz	Acknowledge value external latch 2 (positive rise)
	00000100 00000000	z4zz	Acknowledge value external latch 2 (negative rise)
12-15	00010000 00000000	1zzz	Zustand Digital Input 4
	00100000 00000000	2zzz	Zustand Digital Input 3
	01000000 00000000	4zzz	Zustand Digital Input 2
	10000000 00000000	8zzz	Zustand Digital Input 1

4.13 Mailbox Handling

With EtherCAT, acyclical data traffic (object channel or SDO channel) is called mailbox.

NOTE

Available SDO objects are listed in the ("Appendix" (→ p. 53)).

This system is based around the master:

Mailbox Output:

The master (EtherCAT controller) sends data to the slave (drive). This is essentially a (read/write) request from the master. Mailbox output operates via Sync Manager 0.

Mailbox Input:

The slave (drive) sends data to the master (EtherCAT controller). The master reads the slave's response. Mailbox input operates via Sync Manager 1.

Timing diagram

The timing diagram illustrates the mailbox access process:



1. The EtherCAT master writes the mailbox request to the mail-out buffer.
2. On the next interrupt, the EtherCAT interface activates a Sync Manager 0 event (mailbox output event) in the AL event register.
3. The drive reads 16 bytes from the mail-out buffer and copies them to the internal mailbox output array.
4. The drive identifies new data in the internal mailbox output array and performs an SDO access to the object requested by the EtherCAT interface. The response from the drive is written to an internal mailbox input array.
5. The drive deletes all data in the internal mailbox output array so that a new mailbox access attempt can be made.
6. The drive copies the response telegram from the internal mailbox input array to the mail-in buffer of the EtherCAT interface.

4.13.1 Mailbox Output

An interrupt by the EtherCAT-interface with a Sync Manager 0 - Event starts a Mailbox Output Process. A 1 in the Mail Out Event-Bit of the AL Event register signals the drive, that the EtherCAT-interface wants to send a Mailbox message and that it has already stored the required data in the Mail Out Buffer. Now 16 Byte data are read by the drive with the IRQ process. The bytes are defined as follows

Address 0x1800								Address 0x180F							
0	1	2	3	4	5	6	7	8	9	10	11	12	13	14	15
CAN over EtherCAT specific data (CoE Header)								CAN specific data (standard CAN SDO)							
Byte 0	Length of the data (Low Byte)														
Byte 1	Length of the data (High Byte)														
Byte 2	Address (Low Byte)														
Byte 3	Address (High Byte)														
Byte 4	Bit 0 to 5: Channel Bit 6 to 7: Priority														
Byte 5	Bit 0 to 3: Type							1 = Reserved: ADS over EtherCAT 2 = Reserved: Ethernet over EtherCAT 3 = Can over EtherCAT...							
	Bit 4 to 7: Reserved														
Byte 6	PDO Number (with PDO transmissions only, Bit 0 = LSB of the PDO number, see Byte 7 for MSB)														
Byte 7	Bit 0: MSB of the PDO number, see Byte 6														
	Bit 1 to 3: Reserved														
	Bit 4 to 7: CoE specific type							0: Reserved							
								1: Emergency message							
								2: SDO request							
								3: SDO answer							
								4: TXPDO							
								5: RxPDO							
								6: Remote transmission request of a TxPDO							
							7: Remote transmission request of a RxPDO								
							8...15: reserved								
Byte 8	Control-Byte in the CAN telegram:														
	write access:							0x23=4Byte, 0x27=3Byte, 0x2B=2Byte, 0x2F=1Byte							
	read access:							0x40							
Byte 9	Low Byte of the CAN object number (Index)														
Byte 10	High Byte of the CAN object number (Index)														
Byte 11	Subindex according to CANopen Specification for the drive														
Byte 12	Data with a write access (Low Byte)														
Byte 13	Data with a write access														
Byte 14	Data with a write access														
Byte 15	Data with a write access (High Byte)														

The drive answers every telegram with an answer in the Mailbox Input buffer.

4.13.2 Mailbox Input

The drive answers every CoE telegram with a 16 byte answer telegram in the Mailbox Input buffer. The bytes are defined as follows:

Address 0x1C00								Address 0x1C0F							
0	1	2	3	4	5	6	7	8	9	10	11	12	13	14	15
CAN over EtherCAT specific data (CoE Header)								CAN specific data (standard CAN SDO)							
Byte 0	Length of the data (Low Byte)														
Byte 1	Length of the data (High Byte)														
Byte 2	Address (Low Byte)														
Byte 3	Address (High Byte)														
Byte 4	Bit 0 to 5: Channel Bit 6 to 7: Priority														
Byte 5	Bit 0 to 3: Type							1 = Reserved: ADS over EtherCAT 2 = Reserved: Ethernet over EtherCAT 3 = Can over EtherCAT...							
	Bit 4 to 7: Reserved														
Byte 6	PDO Number (with PDO transmissions only, Bit 0 = LSB of the PDO number, see Byte 7 for MSB)														
Byte 7	Bit 0: MSB of the PDO number, see Byte 6														
	Bit 1 to 3: Reserved														
	Bit 4 to 7: CoE specific type							0: Reserved							
								1: Emergency message							
								2: SDO request							
								3: SDO answer							
								4: TXPDO							
								5: RxPDO							
								6: Remote transmission request of a TxPDO							
							7: Remote transmission request of a RxPDO								
							8...15: reserved								
Byte 8	Control-Byte in the CAN telegram:														
	write access OK:							0x60							
	read access OK + length of answer:							0x43 (4 Byte), 0x47 (3 Byte), 0x4B (2Byte), 0x4F (1Byte)							
	error with read- or write access:							0x80							
Byte 9	Low Byte of the CAN object number (Index)														
Byte 10	High Byte of the CAN object number (Index)														
Byte 11	Subindex according to CANopen Specification for Kollmorgen drive														
Byte 12	Data (Low Byte)														
Byte 13	Data							error code Fehlercode according to CAN-open Specification in case of an error							
Byte 14	Data							data value of the object in case of successful read access							
Byte 15	Data (High Byte)														

4.13.3 Example: Mailbox Access

In the example below, PDOs 0x1704 are mapped (see Chapter "Fixed PDO Mappings" (→ p. 35) "Fixed PDO Mappings"):

The master sends this mailbox output message:

Byte 0	0x0A	The next 10 Bytes contain data (Byte 2 to Byte 11)
Byte 1	0x00	The next 10 Bytes contain data (Byte 2 to Byte 11)
Byte 2	0x00	Address 0
Byte 3	0x00	Address 0
Byte 4	0x00	Channel 0 and Priority 0
Byte 5	0x03	CoE Object
Byte 6	0x00	PDO Number 0
Byte 7	0x20	PDO Number 0 and SDO-Request
Byte 8	0x2B	2 Byte write access
Byte 9	0x12	SDO-Object 0x1C12
Byte 10	0x1C	SDO-Object 0x1C12
Byte 11	0x01	Subindex 1
Byte 12	0x04	Data value 0x00001704
Byte 13	0x17	Data value 0x00001704
Byte 14	0x00	Data value 0x00001704
Byte 15	0x00	Data value 0x00001704

The drive returns the following message:

Byte 0	0x0E	The next 14 Bytes contain data (Byte 2 to Byte 15)
Byte 1	0x00	The next 14 Bytes contain data (Byte 2 to Byte 15)
Byte 2	0x00	Address 0
Byte 3	0x00	Address 0
Byte 4	0x00	Channel 0 and Priority 0
Byte 5	0x03	CoE Object
Byte 6	0x00	PDO Number 0
Byte 7	0x20	PDO Number 0 and SDO-Answer
Byte 8	0x60	Successful write access
Byte 9	0x12	SDO-Object 0x1C12
Byte 10	0x1C	SDO-Object 0x1C12
Byte 11	0x01	Subindex 1
Byte 12	0x00	Data value 0x00000000
Byte 13	0x00	Data value 0x00000000
Byte 14	0x00	Data value 0x00000000
Byte 15	0x00	Data value 0x00000000

4.14 Fieldbus Parameters

The AKD holds several fieldbus-specific, general purpose parameters. Some of them contain the following EtherCAT relevant data:

FBUS.PARAM02:

This parameter activates the synchronization feature of the AKD. The DC feature must be activated in order to allow the AKD to get synchronized with the master. A value of 1 enables the drive internal PLL functionality, a value of 0 deactivates this feature.

FBUS.PARAM03:

This parameter contains the Configured Station Alias address of the AKD. An EEPROM emulation write access to the Configured Station Alias address forces the AKD to store the drive parameters automatically using the DRV.NVSAVE command.

FBUS.PARAM04:

This parameter enables (1) or disables(0) the synchronization supervision of the CANOpen or EtherCAT fieldbus.

Default values for this parameter are as follows:

CANopen drive: disabled (0)

EtherCAT drive: enabled (1)

Synchronization supervision is active when FBUS.PARAM 04 = 1 and the first CANOpen Sync message or first EtherCAT frame is received. When more than three CANOpen sync messages or seven EtherCAT frames have not been received and the drive is enabled, fault F125 ("Synchronization lost"), occurs.

FBUS.PARAM05

Bit 0	1	Faults can only be reset using DS402 control word bit 7.
	0	The reset can also be done via telnet or digital input and the DS402 state machine reflects this condition.
Bit 1	1	The state of the hardware enable does not change the state machine state Operation Enable.
	0	If the state Operation Enable or Switched on is active it falls back to the state switched On Disabled, if the Hardware enable goes to 0.
Bit 2	1	WorkBench/Telnet can not software enable the drive, when CAN-open/EtherCAT are Operational.
	0	WorkBench/Telnet can software enable the drive. NOTE: During commissioning this bit should be set to 1 to avoid influences to DS402 power stage state machine. The field bus should not be in operation as well to avoid influence to test functions of Workbench.
Bit 3	1	DS402-state machine is not influenced, if the software-enable is taken away via Telnet.
	0	DS402-state machine is influenced, if the software-enable is taken away via Telnet.
Bit 4	1	Scaling is done via special DS402 - objects (independent on units)
	0	Scaling for position, velocity and acceleration objects is done via UNIT parameters.

Bit 5	1	FBUS.PARAM03 defines the station alias address if not 0. If FBUS.PARAM03 set to 0, the address will be taken from rotary switches instead, if they are not 0. The EtherCAT master has the ability to use the alias address, selected by the drive, or issue its own.
	0	The rotary switches define the station alias address if not 0. If the rotary switches are set to 0, the address will be taken from FBUS.PARAM03 instead, if it is not 0.
Bit 6	1	Bit 0 of parameter MT.CNTL (object 35B9 sub 0) can be accessed.
	0	Bit 0 of parameter MT.CNTL (object 35B9 sub 0) is exclusively used for DS402 controlword.
Bit 7		reserved
Bit 8	1	DS402-state SWITCHED ON means power stage disabled.
	0	DS402-state SWITCHED ON means power stage enabled.
Bit 9	1	SDO content of object 0x6063 is the same as PDO content.
	0	SDO content of object 0x6063 depends on AKD unit parameters.
Bit 10 (Bit 10 is active only, if Bit 8 is set)	1	State "Switch On" can be reached without the high-level voltage being active.
	0	State "Switch On" can only be reached when the high-level voltage is active; otherwise the drive will stay in "Ready to Switch On".

4.15 EEPROM Content

AKD has a built-in emulated EEPROM. This EEPROM can be read by the EtherCAT master to get some information about drive properties, like PDO-information, drive name, serial numbers and communication-specific attributes.

They are organized in categories. There are two manufacturer-specific categories implemented in the AKD:

- Category 0x0800: Holds a string with the model type in the format AKD-P00000-NxxC-0000
- Category 0x0801: Holds the firmware version in the format 0x_xx-xx-yyy

5 Appendix

5.1 CANopen Emergency Messages and Error Codes

Emergency messages are triggered by internal equipment errors. They have a high ID-priority to ensure quick access to the bus. An emergency message contains an error field with pre-defined error/fault numbers (2 bytes), an error register (1byte), the error category (1 byte), and additional information. Error numbers 0000h to 7FFFh are defined in the communication or drive profile. Error numbers FF00h to FFFFh have manufacturer-specific definitions.

Error Code	Fault/Warning	Description
0x0000	0	Emergency error free.
0x1080	-	General Warning.
0x1081	-	General Error.
0x3110	F523	DC Bus link over voltage FPGA.
0x3120	F247	DC Bus link voltage exceed allowed thresholds.
0x3130	F503	DC Bus link capacitor overload.
0x3180	n503	Warning: DC Bus link capacitor overload.
0x3210	F501	DC Bus link over-voltage.
0x3220	F502	DC Bus Link under-voltage.
0x3280	n502	Warning: DC Bus Link under-voltage.
0x3281	n521	Warning: Dynamic Braking I ² T.
0x3282	F519	Regen short circuit.
0x3283	n501	Warning: DC Bus link over-voltage.
0x4210	F234	Excessive temperature, device (control board).
0x4310	F235	Excessive temperature, drive (heat sink).
0x4380	F236	Power temperature sensor 2 high.
0x4381	F237	Power temperature sensor 3 high.
0x4382	F535	Power board overtemperature.
0x4390	n234	Warning: Control temperature sensor 1 high.
0x4391	n235	Warning: Power temperature sensor 1 high.
0x4392	n236	Warning: Power temperature sensor 2 high.
0x4393	n237	Warning: Power temperature sensor 3 high.
0x4394	n240	Warning: Control temperature sensor 1 low.
0x4395	n241	Warning: Power temperature sensor 1 low.
0x4396	n242	Warning: Power temperature sensor 2 low.
0x4397	n243	Warning: Control temperature sensor 1 low.
0x4398	F240	Control temperature sensor 1 low.
0x4399	F241	Power temperature sensor 1 low.
0x439A	F242	Power temperature sensor 2 low.
0x439B	F243	Power temperature sensor 3 low.
0x5113	F512	5V0 under voltage.
0x5114	F505	1V2 under voltage.
0x5115	F507	2V5 under voltage.
0x5116	F509	3V3 under voltage.
0x5117	F514	+12V0 under voltage.
0x5118	F516	-12V0 under voltage.

Error Code	Fault/Warning	Description
0x5119	F518	Analog 3V3 under voltage.
0x5180	F504	1V2 over voltage.
0x5181	F506	2V5 over voltage.
0x5182	F508	3V3 over voltage.
0x5183	F510	5V0 over voltage.
0x5184	F513	+12V0 over voltage.
0x5185	F515	-12V0 over voltage.
0x5186	F517	Analog 3V3 over voltage.
0x5530	F105	Hardware memory, non-volatile memory stamp invalid.
0x5580	F106	Hardware memory, non-volatile memory data.
0x5590	F204	Control board EEPROM read failed.
0x5591	F205	Control board EEPROM corrupted serial num stamp.
0x5592	F206	Control board EEPROM corrupted serial num data.
0x5593	F207	Control board EEPROM corrupted parameter stamp.
0x5594	F208	Control board EEPROM corrupted parameter data.
0x5595	F219	Control board EEPROM write failed.
0x55A0	F209	Power board EEPROM read failed.
0x55A1	F210	Power board EEPROM corrupted serial num stamp.
0x55A2	F212	Power board EEPROM corrupted serial num data.
0x55A3	F213	Power board EEPROM corrupted parameter stamp.
0x55A4	F214	Power board EEPROM corrupted parameter data.
0x55A5	F230	Power board EEPROM write failed.
0x55A6	F232	Power board EEPROM invalid data.
0x55B0	F248	Option board EEPROM corrupted.
0x55B1	F249	Option board upstream checksum.
0x55B2	F250	Option board upstream checksum.
0x55B3	F251	Option board watchdog.
0x55B8	F252	Firmware and option board FPGA types are not compatible.
0x55B9	F253	Firmware and option board FPGA versions are not compatible.
0x55C0	F621	Control Board CRC fault.
0x55C1	F623	Power Board CRC fault.
0x55C2	F624	Power Board Watchdog fault.
0x55C3	F625	Power Board Communication fault.
0x55C4	F626	Power Board FPGA not configured.
0x55C5	F627	Control Board Watchdog fault.
0x55C6	n103	Warning: Resident FPGA .
0x55C7	n104	Warning: Operational FPGA .
0x6380	F532	Drive motor parameters setup incomplete.
0x7180	F301	Motor overheat.
0x7182	F305	Motor Brake open circuit.
0x7183	F306	Motor Brake short circuit.
0x7184	F307	Motor Brake applied during enable state.
0x7185	F436	EnDAT overheated.
0x7186	n301	Warning: Motor overheated.
0x7187	F308	Voltage exceeds motor rating.

Error Code	Fault/Warning	Description
0x7188	F560	Regen near capacity, could not prevent over voltage.
0x7189	F312	Brake released when it should be applied.
0x7305	F417	Broken wire in primary feedback.
0x7380	F402	Feedback 1 Analog signal amplitude default.
0x7381	F403	Feedback 1 EnDat communication fault.
0x7382	F404	Feedback 1 illegal hall state.
0x7383	F405	Feedback 1 BiSS watchdog.
0x7384	F406	Feedback 1 BiSS multi cycle.
0x7385	F407	Feedback 1 BiSS sensor.
0x7386	F408	Feedback 1 SFD configuration.
0x7387	F409	Feedback 1 SFD UART overrun.
0x7388	F410	Feedback 1 SFD UART frame.
0x7389	F412	Feedback 1 SFD UART parity.
0x738A	F413	Feedback 1 SFD transfer timeout.
0x738C	F415	Feedback 1 SFD mult. corrupt position.
0x738D	F416	Feedback 1 SFD Transfer incomplete.
0x738E	F418	Feedback 1 power supply fault.
0x738F	F401	Feedback 1 failed to set feedback.
0x7390	n414	Warning: SFD single corrupted position.
0x7391	F419	Encoder init procedure failed.
0x7392	F534	Failed to read motor parameters from feedback device.
0x7393	F421	SFD position sensor fault.
0x7394	F463	Tamagawa encoder: overheat.
0x7395	n451	Warning: Tamagawa encoder battery.
0x7396	n423	Warning: Non volatile memory error, multiturn overflow.
0x7398	F135	Homing is needed.
0x7399	F468	FB2.Source not set.
0x739A	F469	FB1.ENCRES is not power of two.
0x739B	F423	Non volatile memory error, multiturn overflow.
0x739C	F467	Hiperface DSL fault.
0x739D	F452	Multiturn overflow not supported with this feedback.
0x739E	F465	Excessive shock detected by feedback device.
0x73A0	F453	Tamagawa encoder: communication timeout.
0x73A1	F454	Tamagawa encoder: communication transfer incomplete.
0x73A2	F456	Tamagawa encoder: communication CRC.
0x73A3	F457	Tamagawa encoder: communication start timeout.
0x73A4	F458	Tamagawa encoder: communication UART overrun.
0x73A5	F459	Tamagawa encoder: communication UART framing.
0x73A6	F460	Tamagawa encoder: over speed.
0x73A7	F461	Tamagawa encoder: contouring error.
0x73A8	F462	Tamagawa encoder: counting overflow.
0x73A9	F464	Tamagawa encoder: multiturn error.
0x73AA	F451	Tamagawa encoder: battery.
0x73B0	F486	Motor velocity exceeds emulated encoder maximum speed.

Error Code	Fault/Warning	Description
0x73B8	F420	FB3 EnDat communication fault.
0x73C0	F473	Wake and Shake. Insufficient movement.
0x73C1	F475	Wake and Shake. Excessive movement.
0x73C2	F476	Wake and Shake. Fine-coarse delta too large.
0x73C3	F478	Wake and Shake. Overspeed.
0x73C4	F479	Wake and Shake. Loop angle delta too large.
0x73C5	F482	Commutation not initialized.
0x73C6	F483	Motor U phase missing.
0x73C7	F484	Motor V phase missing.
0x73C8	F485	Motor W phase missing.
0x73C9	n478	Warning: Wake and Shake. Overspeed.
0x73D0	F487	Wake and Shake. Validating positive movement failed.
0x73D1	F489	Wake and Shake. Validating negative movement failed.
0x73D2	F490	Wake and Shake. Validating commutation angle time out.
0x73D3	F491	Wake and Shake. Validating commutation angle moved too far.
0x73D4	F492	Wake and Shake. Validating commutation angle required more than MOTOR.ICONT.
0x73D5	F493	Invalid commutation detected, motor accelerates in wrong direction.
0x8130	F129	Life Guard Error or Heartbeat Error.
0x8180	n702	Warning: Fieldbus communication lost.
0x8280	n601	Warning: Modbus data rate is too high.
0x8311	F304	Motor foldback.
0x8331	F524	Drive foldback.
0x8380	n524	Warning: Drive foldback.
0x8381	n304	Warning: Motor foldback.
0x8382	n309	Warning: Motor I ² t load.
0x8383	n580	Warning: Using derivate of position when using sensorless feedback type in position mode.
0x8384	n581	Warning: Zero velocity when using induction sensorless feedback type in position mode.
0x8480	F302	Over speed.
0x8481	F703	Emergency timeout occurred while axis should disable.
0x8482	F480	Fieldbus command velocity too high.
0x8483	F481	Fieldbus command velocity too low.
0x8582	n107	Warning: Positive software position limit is exceeded.
0x8583	n108	Warning: Negative software position limit is exceeded.
0x8584	n704	Warning: PVT buffer overflow.
0x8585	n705	Warning: PVT buffer underflow.
0x8586	n127	Warning: Scale factor of PVT velocity command over range.
0x8611	F439	Following error (user).
0x8685	F138	Instability during autotune.
0x8686	n151	Warning: Not enough distance to move; Motion Exception.
0x8687	n152	Warning: Not enough distance to move; Following Motion Exception.
0x8688	n153	Warning: Velocity Limit Violation, Exceeding Max Limit.
0x8689	n154	Warning: Following Motion Failed; Check Motion Parameters.
0x868A	n156	Warning: Target Position crossed due to Stop command.

Error Code	Fault/Warning	Description
0x86A0	n157	Warning: Homing Index pulse not found.
0x86A1	n158	Warning: Homing Reference Switch not found.
0x86A2	n159	Warning: Failed to set motion task parameters.
0x86A3	n160	Warning: Motion Task Activation Failed.
0x86A4	n161	Warning: Homing Procedure Failed.
0x86A5	F139	Target Position Over Short due to invalid Motion task activation.
0x86A6	n163	Warning: MT.NUM exceeds limit.
0x86A7	n164	Warning: Motion task is not initialized.
0x86A8	n165	Warning: Motion task target position is out.
0x86A9	n167	Warning: Software limit switch traversed.
0x86AA	n168	Warning: Invalid bit combination in the motion task control word.
0x86AB	n169	Warning: 1:1 profile cannot be triggered on the fly.
0x86AC	n170	Warning: Customer profile table is not initialized.
0x86AD	n171	Warning: Motion task activation is currently pending
0x86AE	n135	Warning: Homing is needed.
0x86AF	n174	Warning: Homing maximum distance exceeded
0x86B0	F438	Following error (numeric).
0x8780	F125	Fieldbus synchronization lost.
0x8781	n125	Warning: Fieldbus synchronization lost.
0x8AF0	n137	Warning: Homing and feedback mismatch.
0xFF00	F701	Fieldbus runtime.
0xFF01	F702	Fieldbus communication lost.
0xFF02	F529	Iu current offset limit exceeded.
0xFF03	F530	Iv current offset limit exceeded.
0xFF04	F521	Regen over power.
0xFF07	F525	Output over current.
0xFF08	F526	Current sensor short circuit.
0xFF09	F128	MPOLES/FPOLES not an integer.
0xFF0A	F531	Power stage fault.
0xFF0B	F602	Safe torque off.
0xFF0C	F131	Secondary feedback A/B line break.
0xFF0D	F130	Secondary feedback supply over current.
0xFF0E	F134	Secondary feedback illegal state.
0xFF0F	F245	External fault.
0xFF10	F136	Firmware and FPGA versions are not compatible.
0xFF11	F101	Firmware type mismatch.
0xFF12	n439	Warning: Following error (user).
0xFF13	n438	Warning: Following error (numeric).
0xFF14	n102	Warning: Operational FPGA is not a default FPGA.
0xFF15	n101	Warning: The FPGA is a laboratory FPGA.
0xFF16	n602	Warning: Safe torque off.
0xFF17	F132	Secondary feedback Z line break.
0xFF18	n603	Warning: OPMODE incompatible with CMDSOURCE.
0xFF19	n604	Warning: EMUEMODE incompatible with DRV.HANDWHEELSRC.

5.2 Object Dictionary AKD-C

The following tables describe all objects reachable via SDO or PDO. (i.p. = in preparation).

Abbreviations:

U	= UNSIGNED	RO	= Read only
INT	= INTEGER	RW	= Read and Write
VisStr	= Visible String	WO	= Write only
		const	= Constant

5.2.1 Float Scaling

The scaling applied to objects which match floating-point parameters in WorkBench/Telnet are listed in the column "Float Scaling."

For example, index 607Ah is listed as 1:1 - this means that commanding a value of 1000 in SDO 607Ah is equivalent to entering MT.P 1000.000 in WorkBench. On the other hand, index 3598h is listed as 1000:1 - this means that commanding a value of 1000 in SDO 3598h is equivalent to entering IL.KP 1.000 in WorkBench.

A few parameters are listed as variable (var), because the scaling depends on other settings.

5.2.2 Object Dictionary for AKD-C

Index	Sub-index	Data Type	Access	PDO map.	Description	Drive Parameter
1000h	0	U32	RO	No	Device Type	-
1001h	0	U8	RO	No	Error Register	-
1002h	0	U32	RO	Yes	Manufacturer status register	-
1003h	-	ARRAY	-	-	Pre-defined error field	-
1003h	0	U8	RO	No	Number of errors	DRV.FAULTS DRV.WARNINGS
1003h	1..n	U32	RO	No	Standard error field x (x=1..n)	DRV.FAULTS
1008h	-	String	RO	No	Device Name	-
100Ah	0	String	RO	No	Manufacturer Software Version	-
1018h	-	RECORD	-	-	Identity object	-
1018h	0	U8	RO	No	Highest sub-index supported	-
1018h	1	U32	RO	No	Vendor ID	-
1018h	2	U32	RO	No	Product Code	-
1018h	3	U32	RO	No	Revision Number	-
1018h	4	U32	RO	No	Serial Number	-
1400h	0..2	U8/32	RW	No	R1-PDO communication parameters	-
1401h	0..2	U8/32	RW	No	R2-PDO communication parameters	-
1402h	0..2	U8/32	RW	No	R3-PDO communication parameters	-
1403h	0..2	U8/32	RW	No	R4-PDO communication parameters	-
1600h	0..8	U8/32	RW	No	R1-PDO mapping parameters	-
1601h	0..8	U8/32	RW	No	R2-PDO mapping parameters	-
1602h	0..8	U8/32	RW	No	R3-PDO mapping parameters	-
1603h	0..8	U8/32	RW	No	R4-PDO mapping parameters	-
1800h	0..5	U8/16/32	RW	No	T1-PDO communication parameters	-
1801h	0..5	U8/16/32	RW	No	T2-PDO communication parameters	-
1802h	0..5	U8/16/32	RW	No	T3-PDO communication parameters	-
1803h	0..5	U8/16/32	RW	No	T4-PDO communication parameters	-

Index	Sub-index	Data Type	Access	PDO map.	Description	Drive Parameter
1A00h	0..8	U8/32	RW	No	T1-PDO mapping parameters	-
1A01h	0..8	U8/32	RW	No	T2-PDO mapping parameters	-
1A02h	0..8	U8/32	RW	No	T3-PDO mapping parameters	-
1A03h	0..8	U8/32	RW	No	T4-PDO mapping parameters	-
3000h	0	U16	RW	Yes	Clear faults	DRV.CLRFAULTS
3001h	0	S32	RO	Yes	Bus Voltage	VBUS.VALUE
3002h	0	S32	RO	Yes	String Voltage	STRINGS.VVALUE
3003h	-	ARRAY	-	-	String Currents	-
3003h	0	U8	RO	No	Highest sub-index supported	-
3003h	1	U32	RO	Yes	Sum of string currents.	STRINGS.IVALUE
3004h	-	ARRAY	-	-	String I2t values	-
3004h	0	U8	RO	No	Highest sub-index supported	-
3004h	1	U16	RO	Yes	Overall string I2T's	STRINGS.I2TVALUE
3005h	-	ARRAY	-	-	Strings current thresholds	-
3005h	0	U8	RO	No	Highest sub-index supported	-
3006h	-	ARRAY	-	-	Strings I2t thresholds	-
3006h	0	U8	RO	No	Highest sub-index supported	-
3006h	1	U16	RO	No	Current warning threshold for both AKD-N strings in mA.	STRINGS.I2TWTRESH
3006h	2	U16	RO	No	Current fault threshold for both AKD-N strings in mA	STRINGS.I2TFTRESH
3020h	-	ARRAY	-	-	Strings number of nodes	-
3020h	0	U8	RO	No	Highest sub-index supported	-
3020h	1	U8	RO	No	Number of AKD-N found on string 1.	STRING1.NODECOUNT
3020h	2	U8	RO	No	Number of AKD-N found on string 2.	STRING2.NODECOUNT
3021h	-	ARRAY	-	-	Strings number of nodes.	-
3021h	0	U8	RO	No	Highest sub-index supported.	-
3021h	1	U16	RO	No	Bit information of enable state of AKD-N on string 1.	STRING1.DRIVESENABLED
3021h	2	U16	RO	No	Bit information of enable state of AKD-N on string 2.	STRING2.DRIVESENABLED
6100h	-	ARRAY	-	-	Number of Inputs 16-bit	-
6100h	0	U8	RO	No	Highest sub-index supported.	-
6100h	1	U16	RO	Yes	Read input.	STRINGS.ENABLE
6300h	-	ARRAY	-	-	Number of Outputs 16-bit	-
6300h	0	U8	RO	No	Highest sub-index supported	-
6300h	1	U16	RW	Yes	Write output	DOUT1.STATEU
6308h	-	ARRAY	-	-	Filter mask digital outputs	-
6308h	0	U8	RO	No	Highest sub-index supported	-
6308h	1	U16	RW	Yes	Filter mask output 01h to 10h	-

5.3 Object Dictionary AKD-N

The following tables describe all objects reachable via SDO or PDO. (i.p. = in preparation).

Abbreviations:

U	= UNSIGNED	RO	= Read only
INT	= INTEGER	RW	= Read and Write
VisStr	= Visible String	WO	= Write only
		const	= Constant

5.3.1 Float Scaling

The scaling applied to objects which match floating-point parameters in WorkBench/Telnet are listed in the column "Float Scaling."

For example, index 607Ah is listed as 1:1 - this means that commanding a value of 1000 in SDO 607Ah is equivalent to entering MT.P 1000.000 in WorkBench. On the other hand, index 3598h is listed as 1000:1 - this means that commanding a value of 1000 in SDO 3598h is equivalent to entering IL.KP 1.000 in WorkBench.

A few parameters are listed as variable (var), because the scaling depends on other settings.

5.3.2 Communication SDOs

Index	Sub-index	Data Type	Access	PDO map.	Description	ASCII object
1000h	0	U32	RO	no	Device type	—
1001h	0	U8	RO	no	Error register	—
1002h	0	U32	RO	yes	Manufacturer-specific status register	—
1003h		ARRAY			Pre-defined error field	—
1003h	0	U8	RW	no	Number of errors	—
1003h	1 to 10	U32	RO	no	standard error field	—
1005h	0	U32	RW	no	COB—ID SYNC message	—
1006h	0	U32	RW	no	Communication cycle period	—
1008h	0	VisStr	const	no	Manufacturer device name	—
1009h	0	VisStr	const	no	Manufacturer hardware version	—
100Ah	0	VisStr	const	no	Manufacturer software version	—
100Ch	0	U16	RW	no	Guard time	—
100Dh	0	U8	RW	no	Lifetime factor	—
1010h		ARRAY			Save parameters	—
1010h	0	U8	RO	no	Number of entries	—
1010h	1	U32	RW	no	Saves the drive parameters from the RAM to the NV.	DRV.NVSAVE
1011h		ARRAY			Load parameters	—
1011h	0	U8	RO	no	Number of entries	—
1011h	1	U32	RW	no	Loads default parameters to the RAM.	DRV.RSTVAR
1012h	0	U32	RW	no	COB—ID for the Time Stamp	—
1014h	0	U32	RW	no	COB—ID for the Emergency Object	—
1016h		RECORD			Consumer heartbeat time	—
1016h	0	U8	RO	no	Number of entries	—
1016h	1	U32	RW	no	Consumer heartbeat time	—
1017h	0	U16	RW	no	Producer heartbeat time	—

Index	Sub-index	Data Type	Access	PDO map.	Description	ASCII object
1018h		RECORD			Identity Object	—
1018h	0	U8	RO	no	Number of entries	—
1018h	1	U32	RO	no	Vendor ID	—
1018h	2	U32	RO	no	Product Code	—
1018h	3	U32	RO	no	Revision number	—
1018h	4	U32	RO	no	Serial number	—
1026h		ARRAY			OS prompt	—
1026h	0	U8	RO	no	Number of entries	—
1026h	1	U8	WO	no	StdIn	—
1026h	2	U8	RO	no	StdOut	—
1400h		RECORD			RXPDO1 communication parameter	—
1400h	0	U8	RO	no	Number of entries	—
1400h	1	U32	RW	no	RXPDO1 COB—ID	—
1400h	2	U8	RW	no	Transmission type RXPDO1	—
1401h		RECORD			RXPDO2 communication parameter	—
1401h	0	U8	RO	no	Number of entries	—
1401h	1	U32	RW	no	RXPDO2 COB—ID	—
1401h	2	U8	RW	no	Transmission type RXPDO2	—
1402h		RECORD			RXPDO3 communication parameter	—
1402h	0	U8	RO	no	Number of entries	—
1402h	1	U32	RW	no	RXPDO3 COB—ID	—
1402h	2	U8	RW	no	Transmission type RXPDO3	—
1403h		RECORD			RXPDO4 communication parameter	—
1403h	0	U8	RO	no	Number of entries	—
1403h	1	U32	RW	no	RXPDO4 COB—ID	—
1403h	2	U8	RW	no	Transmission type RXPDO4	—
1600h		RECORD			RXPDO1 mapping parameter	—
1600h	0	U8	RO	no	Number of entries	—
1600h	1 to 8	U32	RW	no	Mapping for n—th application object	—
1601h		RECORD			RXPDO2 mapping parameter	—
1601h	0	U8	RO	no	Number of entries	—
1601h	1 to 8	U32	RW	no	Mapping for n—th application object	—
1602h		RECORD			RXPDO3 mapping parameter	—
1602h	0	U8	RO	no	Number of entries	—
1602h	1 to 8	U32	RW	no	Mapping for n—th application object	—
1603h		RECORD			RXPDO4 mapping parameter	—
1603h	0	U8	RO	no	Number of entries	—
1603h	1 to 8	U32	RW	no	Mapping for n—th application object	—
1800h		RECORD			TXPDO1 communication parameter	—
1800h	0	U8	RO	no	Number of entries	—
1800h	1	U32	RW	no	TXPDO1 COB—ID	—
1800h	2	U8	RW	no	Transmission type TXPDO1	—
1800h	3	U16	RW	no	Inhibit time	—
1800h	4	U8	const	no	reserved	—

Index	Sub-index	Data Type	Access	PDO map.	Description	ASCII object
1800h	5	U16	RW	no	Event timer	—
1801h		RECORD			TXPDO2 communication parameter	—
1801h	0	U8	RO	no	Number of entries	—
1801h	1	U32	RW	no	TXPDO2 COB—ID	—
1801h	2	U8	RW	no	Transmission type TXPDO2	—
1801h	3	U16	RW	no	Inhibit time	—
1801h	4	U8	const	no	reserved	—
1801h	5	U16	RW	no	Event timer	—
1802h		RECORD			TXPDO3 communication parameter	—
1802h	0	U8	RO	no	Number of entries	—
1802h	1	U32	RW	no	TXPDO3 COB—ID	—
1802h	2	U8	RW	no	Transmission type TXPDO3	—
1802h	3	U16	RW	no	Inhibit time	—
1802h	4	U8	const	no	reserved	—
1802h	5	U16	RW	no	Event timer	—
1803h		RECORD			TXPDO4 communication parameter	—
1803h	0	U8	RO	no	Number of entries	—
1803h	1	U32	RW	no	TXPDO4 COB—ID	—
1803h	2	U8	RW	no	Transmission type TXPDO4	—
1803h	3	U16	RW	no	Inhibit time	—
1803h	4	U8	const	no	reserved	—
1803h	5	U16	RW	no	Event timer	—
1A00h		RECORD			Mapping parameter TXPDO1	—
1A00h	0	U8	RO	no	Number of entries	—
1A00h	1 to 8	U32	RW	no	Mapping for n—th application object	—
1A01h		RECORD			Mapping parameter TXPDO2	—
1A01h	0	U8	RO	no	Number of entries	—
1A01h	1 to 8	U32	RW	no	Mapping for n—th application object	—
1A02h		RECORD			Mapping parameter TXPDO3	—
1A02h	0	U8	RO	no	Number of entries	—
1A02h	1 to 8	U32	RW	no	Mapping for n—th application object	—
1A03h		RECORD			Mapping parameter TXPDO4	—
1A03h	0	U8	RO	no	Number of entries	—
1A03h	1 to 8	U32	RW	no	Mapping for n—the application object	—

5.3.3 Manufacturer specific SDOs

Objects 2000h to 3999h

Index	Sub-index	Data Type	Float Scale	Access	PDO map.	Description	ASCII object
2000h		ARRAY				System Warnings	—
2000h	0	U8		RO	no	Number of entries	—
2000h	1	U32		RO	no	System Warning 1	DRV.WARNING1
2000h	2	U32		RO	no	System Warning 2	DRV.WARNING2
2000h	3	U32		RO	no	System Warning 3	DRV.WARNING3
2001h		ARRAY				System Faults	—
2001h	0	U8		RO	no	Number of entries	—
2001h	1	U32		RO	no	System Fault 1	DRV.FAULT1
2001h	2	U32		RO	no	System Fault 2	DRV.FAULT2
2001h	3	U32		RO	no	System Fault 3	DRV.FAULT3
2001h	4	U32		RO	no	System Fault 4	DRV.FAULT4
2001h	5	U32		RO	no	System Fault 5	DRV.FAULT5
2001h	6	U32		RO	no	System Fault 6	DRV.FAULT6
2001h	7	U32		RO	no	System Fault 7	DRV.FAULT7
2001h	8	U32		RO	no	System Fault 8	DRV.FAULT8
2001h	9	U32		RO	no	System Fault 9	DRV.FAULT9
2001h	A	U32		RO	no	System Fault 10	DRV.FAULT10
2002h		ARRAY				Manufacturer status bytes	—
2002h	0	U8		RO	no	Number of entries	—
2002h	1	U8		RO	yes	Manufacturer status bytes 1	—
2002h	2	U8		RO	yes	Manufacturer status bytes 2	—
2002h	3	U8		RO	yes	Manufacturer status bytes 3	—
2002h	4	U8		RO	yes	Manufacturer status bytes 4	—
2014h		ARRAY				Mask TxPDO Channel 1	—
2014h	1	U32		RW	no	Mask (Byte 0..3)	—
2014h	2	U32		RW	no	Mask (Byte 4..7)	—
2015h		ARRAY				Mask TxPDO Channel 2	—
2015h	1	U32		RW	no	Mask (Byte 0..3)	—
2015h	2	U32		RW	no	Mask (Byte 4..7)	—
2016h		ARRAY				Mask TxPDO Channel 3	—
2016h	1	U32		RW	no	Mask (Byte 0..3)	—
2016h	2	U32		RW	no	Mask (Byte 4..7)	—
2017h		ARRAY				Mask TxPDO Channel 4	—
2017h	1	U32		RW	no	Mask (Byte 0..3)	—

Index	Sub-index	Data Type	Float Scale	Access	PDO map.	Description	ASCII object
2017h	2	U32		RW	no	Mask (Byte 4..7)	—
2018h		ARRAY				Firmware version	—
2018h	0	U16		const	no	Number of entries	—
2018h	1	U16		const	no	Major version	—
2018h	2	U16		const	no	Minor version	—
2018h	3	U16		const	no	Revision	—
2018h	4	U16		const	no	Branch version	—
204Ch		ARRAY				pv scaling factor	—
204Ch	0	U8		RO	no	Number of entries	—
204Ch	1	INT32		RW	no	pv scaling factor numerator	—
204Ch	2	INT32		RW	no	pv scaling factor denominator	—
2071h	0	INT32		RW	yes	Target current	-
2077h	0	INT32		RO	yes	Current actual value	-
20A0h	0	INT32	var	RO	yes	Latch position 1, positive edge	CAP0.PLFB , CAP0.T
20A1h	0	INT32	var	RO	yes	Latch position 1, negative edge	CAP0.PLFB , CAP0.T
20A2h	0	INT32	var	RO	yes	Latch position 2, positive edge	CAP1.PLFB , CAP1.T
20A3h	0	INT32	var	RO	yes	Latch position 2, negative edge	CAP1.PLFB , CAP1.T
20A4h	0	U16		RW	yes	Latch control register	—
20A5h	0	U16		RW	yes	Latch status register	—
20A6h	0	INT32	var	RO	yes	Gets captured position value	CAP0.PLFB
20A7h	0	INT32	var	RO	yes	Gets captured position value	CAP1.PLFB
20B8h	0	U16		RW	yes	Clear changed digital input information	—
3405h		ARRAY				VL.ARTYPE	—
3405h	0	U8		RO	no	Number of entries	—
3405h	1	U8		RW	no	Calculation method for BiQuad filter 1	VL.ARTYPE1
3405h	2	U8		RW	no	Calculation method for BiQuad filter 2	VL.ARTYPE2
3405h	3	U8		RW	no	Calculation method for BiQuad filter 3	VL.ARTYPE3
3405h	4	U8		RW	no	Calculation method for BiQuad filter 4	VL.ARTYPE4
3406h		ARRAY				VL BiQuad	—
3406h	0	U8		RO	no	Number of entries	—
3406h	1	U32	1000:1	RW	no	Natural frequency of pole of anti-resonance (AR) filter 1	VL.ARPF1

Index	Sub-index	Data Type	Float Scale	Access	PDO map.	Description	ASCII object
3406h	2	U32	1000:1	RW	no	Natural frequency of pole of anti-resonance (AR) filter 2	VL.ARPF2
3406h	3	U32	1000:1	RW	no	Natural frequency of pole of anti-resonance (AR) filter 3	VL.ARPF3
3406h	4	U32	1000:1	RW	no	Natural frequency of pole of anti-resonance (AR) filter 4	VL.ARPF4
3406h	5	U32	1000:1	RW	no	Q of pole of anti-resonance (AR) filter 1	VL.ARPQ1
3406h	6	U32	1000:1	RW	no	Q of pole of anti-resonance (AR) filter 2	VL.ARPQ2
3406h	7	U32	1000:1	RW	no	Q of pole of anti-resonance (AR) filter 3	VL.ARPQ3
3406h	8	U32	1000:1	RW	no	Q of pole of anti-resonance (AR) filter 4	VL.ARPQ4
3406h	9	U32	1000:1	RW	no	Natural frequency of zero of anti-resonance (AR)filter 1	VL.ARZF1
3406h	A	U32	1000:1	RW	no	Natural frequency of zero of anti-resonance (AR)filter 2	VL.ARZF2
3406h	B	U32	1000:1	RW	no	Natural frequency of zero of anti-resonance (AR)filter 3	VL.ARZF3
3406h	C	U32	1000:1	RW	no	Natural frequency of zero of anti-resonance (AR)filter 4	VL.ARZF4
3406h	D	U32	1000:1	RW	no	Q of zero of anti-resonance filter 1	VL.ARZQ1
3406h	E	U32	1000:1	RW	no	Q of zero of anti-resonance filter 2	VL.ARZQ2
3406h	F	U32	1000:1	RW	no	Q of zero of anti-resonance filter 3	VL.ARZQ3
3406h	10	U32	1000:1	RW	no	Q of zero of anti-resonance filter 4	VL.ARZQ4
3407h		STRUCT				Velocity Filter	—
3407h	0	U8		RO	no	Number of entries	—
3407h	1	INT32	1000:1	RW	no	10 Hz filtered VL.FB	VL.FBFILTER
3407h	2	U32	1000:1	RW	no	Gain for the velocity feedforward	VL.KVFF
3407h	3	U32		RW	no	Gain for the acceleration feedforward	VL.KBUSFF
3407h	4	U32	1:1	RW	no	Sets the velocity error	VL.ERR
3420h	0	U16	1000:1	RW	no	Sets the foldback fault level.	IL.FOLDFTHRESH

Index	Sub-index	Data Type	Float Scale	Access	PDO map.	Description	ASCII object
3421h	0	U32	1000:1	RW	no	Sets the user value for the foldback fault level.	IL.FOLDFTHRESHU
3422h	0	U32	1000:1		no	Sets friction compensation value.	IL.FRICTION
3423h	0	INT32	1000:1		no	A constant current command added to compensate for gravity.	IL.OFFSET
3424h	0	U16			no	Enables/disables the integrator part of the PI loop.	IL.INTEN (Password Protected)
3425h	0	U32	1000:1	RO	no	Reads the overall foldback current limit	IL.IFOLD
3426h	0	U32	1000:1	RW	no	Sets current loop acceleration feedforward gain value	IL.KACFF
3427h		RECORD				Motor protection parameters	—
3427h	0	U8		RO	no	Number of entries	—
3427h	1	U8		RW	no		IL.MIMODE
3427h	2	U8		RW	no		IL.MI2TWTRESH
3427h	3	U32		RW	yes		IL.MI2T
3430h	0	U8		RW	no	Sets the direction for absolute motion tasks.	PL.MODPDIR
3431h	0	U16		RW	no	Sets the motion task in the drive	MT.SET
3440h		ARRAY				Controlled stop parameters	—
3440h	0	U8		RO	no	Number of entries	—
3440h	1	U32	1:1	RW	no	Sets the deceleration value for a controlled stop.	CS.DEC
3440h	2	U32	1:1	RW	no	Sets the velocity threshold for a controlled stop.	CS.VTHRESH
3440h	3	U32		RW	no	Sets the time value for the drive velocity to be within CS.VTHRESH.	CS.TO
3441h	0	U8		RO	no	Controlled stop state	CS.STATE
3443h	0	U16		RO	no	Returns the possible reason for a drive disable	DRV.DIS
3444h	0	U16	1000:1	RO	no	Maximum current for dynamic braking	DRV.DBILIMIT
3445h	0	U32		RO	no	Emergency timeout for braking	DRV.DISTO
3450h	0	U8		WO	no	Release or enable brake	MOTOR.BRAKERLS
3451h	0	U8		RW	no	Determines which drive parameters are calculated automatically.	MOTOR.AUTOSSET

Index	Sub-index	Data Type	Float Scale	Access	PDO map.	Description	ASCII object
3452h	0	U16		RW	no	Sets the motor maximum voltage	MOTOR.VOLTMAX
3453h	0	U32		RW	no	Sets the motor temperature warning level	MOTOR.TEMPWARN
3454h	0	U32	1000:1	RW	no	Sets the thermal constant of the motor coil	MOTOR.CTF0
3455h	0	U32	1000:1	RW	no	Sets the line-to-line motor Lq	MOTOR.LQLL
3456h	0	U32	1000:1	RW	no	Sets the stator winding resistance phase-phase in ohms	MOTOR.R
3457h		RECORD				Induction Motor parameter	—
3457h	0	U8		RO	no	Number of entries	—
3457h	1	INT32	1000:1	RW	no	Configuration of induction motor's rated velocity.	MOTOR.VRATED
3457h	2	U16		RW	no	Configuration of induction motor's rated voltage.	MOTOR.VOLTRATED
3457h	3	U16		RW	no	Sets the minimum voltage for V/f Control.	MOTOR.VOLTMIN
345Ah		ARRAY				Brake Control	—
345Ah	0	U8		RO	no	Number of entries	—
345Ah	1	U16		RW	yes	Brake Control Command	—
345Ah	2	U16		RO	yes	Brake Status Response.	—
3460h		RECORD				Capture engines parameters	—
3460h	0	U8		RO	no	Number of entries	—
3460h	1	U8		RW	no	Specifies the trigger source for the position capture.	CAP0.TRIGGER
3460h	2	U8		RW	no	Specifies the trigger source for the position capture.	CAP1.TRIGGER
3460h	3	U8		RW	no	Selects the captured value.	CAP0.MODE
3460h	4	U8		RW	no	Selects the captured value.	CAP1.MODE
3460h	5	U8		RW	no	Controls the pre-condition logic.	CAP0.EVENT
3460h	6	U8		RW	no	Controls the pre-condition logic.	CAP1.EVENT
3460h	7	U8		RW	no	Selects the capture pre-condition edge.	CAP0.PREEDGE

Index	Sub-index	Data Type	Float Scale	Access	PDO map.	Description	ASCII object
3460h	8	U8		RW	no	Selects the capture precondition edge.	CAP1.PREEDGE
3460h	9	U8		RW	no	Sets the precondition trigger.	CAP0.PRESELECT
3460h	A	U8		RW	no	Sets the precondition trigger.	CAP1.PRESELECT
3474h		ARRAY				DINx.PARAM	—
3474h	0	U8		RO	no	Number of entries	—
3474h	1	U32		RW	no	Lower 32-bit part of input parameter 1	DIN1.PARAM
3474h	2	U32		RW	no	Lower 32-bit part of input parameter 2	DIN2.PARAM
3474h	3	U32		RW	no	Lower 32-bit part of input parameter 3	DIN3.PARAM
3474h	4	U32		RW	no	Higher 32-bit part of input parameter 1	DIN1.PARAM
3474h	5	U32		RW	no	Higher 32-bit part of input parameter 2	DIN2.PARAM
3474h	6	U32		RW	no	Higher 32-bit part of input parameter 3	DIN3.PARAM
3475h		ARRAY				DOUtx.PARAM	—
3475h	0	U8		RO	no	Number of entries	—
3475h	1	U32		RW	no	Lower 32-bit part of output parameter 1	DOUT1.PARAM
3475h	2	U32		RW	no	Higher 32-bit part of output parameter 1	DOUT1.PARAM
3480h	0	U32	1000:1	RW	no	Integral gain of position regulator PID loop	PL.KI
3481h		ARRAY				PL.INTMAX	—
3481h	0	U8		RO	no	Number of entries	—
3481h	1	U32	1:1	RW	no	Input saturation	PL.INTINMAX
3481h	2	U32	1:1	RW	no	Output saturation	PL.INTOUTMAX
3482h	0	INT32	1:1	RO	no	Maximum value of following error in homing	HOME.PERRTHRESH
3483h	0	INT32	1:1	RW	no	Sets the position error warning level	PL.ERRWTHRESH
3484h	0	INT32	1:1	RW	no	Specification of an additional movement after homing is completed.	HOME.DIST
3490h	0	INT32	1:1	RO	no	Position feedback offset	FB1.POFFSET
3492h	0	U32		RO	no	Motion status of the drive	DRV.MOTIONSTAT
3494h		RECORD				WS parameters	—
3494h	0	U8		RO	no	Number of entries	—

Index	Sub-index	Data Type	Float Scale	Access	PDO map.	Description	ASCII object
3494h	1	INT16	1000:1	RW	no	Sets maximum current used for wake and shake	WS.IMAX
3494h	2	INT32	1:1	RW	no	Sets the maximum movement required for wake and shake	WS.DISTMAX
3494h	3	U16		RW	no	Sets the delay for wake and shake between loops in mode 0	WS.TDELAY3
3494h	4	INT32	1:1	RW	no	Defines the maximum allowed velocity for Wake & Shake	WS.VTHRESH
3494h	5	U8		RO	no	Reads wake and shake status	WS.STATE
3494h	6	U8		RW	no	Arm Wake and Shake to start	WS.ARM
3495h	0	U16	1000:1	RW	no	Voltage level for under-voltage warning.	VBUS.UVWTHRESH
3496h		ARRAY				FBUS synchronization parameters	—
3496h	0	U8		RO	no	Number of entries	—
3496h	1	U32		RW	no	expected time distance between clearing the PLL counter and calling the PLL function	FBUS.SYNCDIST
3496h	2	U32		RW	no	actual time distance between clearing the PLL counter and calling the PLL function	FBUS.SYNCACT
3496h	3	U32		RW	no	Time window, which is used in order to consider the drive as being synchronized	FBUS.SYNCWND
3496h	4	U32		RW	no	Time, which is used for extending or lowering the sample rate of the internal 16[kHz] IRQ	—
3498h	0	U8		RW	no	Protection level of field-bus against other communication channels (Telnet, Modbus..)	FBUS.PROTECTION
3499h	0	INT32		RW	yes	Set-point for stepper motor output through the emulated encoder output (EEO)	DRV.EMUSTEPCMD
34A0h		ARRAY				PLS Position	
34A0h	0	U8		RO	no	Number of entries	—
34A0h	1	INT32	1:1	RW	no	Limit switch 1 compare value	PLS.P1

Index	Sub-index	Data Type	Float Scale	Access	PDO map.	Description	ASCII object
34A0h	2	INT32	1:1	RW	no	Limit switch 2 compare value	PLS.P2
34A0h	3	INT32	1:1	RW	no	Limit switch 3 compare value	PLS.P3
34A0h	4	INT32	1:1	RW	no	Limit switch 4 compare value	PLS.P4
34A0h	5	INT32	1:1	RW	no	Limit switch 5 compare value	PLS.P5
34A0h	6	INT32	1:1	RW	no	Limit switch 6 compare value	PLS.P6
34A0h	7	INT32	1:1	RW	no	Limit switch 7 compare value	PLS.P7
34A0h	8	INT32	1:1	RW	no	Limit switch 8 compare value	PLS.P8
34A1h		ARRAY				PLS Width	—
34A1h	0	U8		RO	no	Number of entries	—
34A1h	1	INT32	1:1	RW	no	Sets Limit Switch1 Width	PLS.WIDTH1
34A1h	2	INT32	1:1	RW	no	Sets Limit Switch 2 Width	PLS.WIDTH2
34A1h	3	INT32	1:1	RW	no	Sets Limit Switch 3 Width	PLS.WIDTH3
34A1h	4	INT32	1:1	RW	no	Sets Limit Switch 4 Width	PLS.WIDTH4
34A1h	5	INT32	1:1	RW	no	Sets Limit Switch 5 Width	PLS.WIDTH5
34A1h	6	INT32	1:1	RW	no	Sets Limit Switch 6 Width	PLS.WIDTH6
34A1h	7	INT32	1:1	RW	no	Sets Limit Switch 7 Width	PLS.WIDTH7
34A1h	8	INT32	1:1	RW	no	Sets Limit Switch 8 Width	PLS.WIDTH8
34A2h		ARRAY				PLS Time	—
34A2h	0	U8		RO	no	Number of entries	—
34A2h	1	U16		RW	no	Sets limit switch 1 time	PLS.T1
34A2h	2	U16		RW	no	Sets limit switch 2 time	PLS.T2
34A2h	3	U16		RW	no	Sets limit switch 3 time	PLS.T3
34A2h	4	U16		RW	no	Sets limit switch 4 time	PLS.T4
34A2h	5	U16		RW	no	Sets limit switch 5 time	PLS.T5
34A2h	6	U16		RW	no	Sets limit switch 6 time	PLS.T6
34A2h	7	U16		RW	no	Sets limit switch 7 time	PLS.T7
34A2h	8	U16		RW	no	Sets limit switch 8 time	PLS.T8
34A3h		ARRAY				PLS Configuration	—
34A3h	0	U8		RO	no	Number of entries	—
34A3h	1	U16		RW	no	Enables the limit switches	PLS.EN
34A3h	2	U16		RW	no	Resets limit switches	PLS.RESET

Index	Sub-index	Data Type	Float Scale	Access	PDO map.	Description	ASCII object
34A3h	3	U16		RW	no	Selects limit switch mode	PLS.MODE
34A3h	4	U16		RW	no	Reads the limit switch state	PLS.STATE
34A4h	0	U8		RW	no	Sets limit switch units	PLS.UNITS
34B0h		ARRAY				USER.DWORDS for writing of feedback memory	—
34B0h	0	U8		RO	no	Number of entries	—
34B0h	1	U32		RW	no	FB1.USERDWORD1	FB1.USERDWORD1
34B0h	2	U32		RW	no	FB1.USERDWORD2	FB1.USERDWORD2
34B1h		ARRAY				USER.WORDS for writing of feedback memory	—
34B1h	0	U8		RO	no	Number of entries	—
34B1h	1	U16		RW	no	FB1.USERWORD1	FB1.USERWORD1
34B1h	2	U16		RW	no	FB1.USERWORD2	FB1.USERWORD2
34B1h	3	U16		RW	no	FB1.USERWORD3	FB1.USERWORD3
34B1h	4	U16		RW	no	FB1.USERWORD4	FB1.USERWORD4
34B2h		ARRAY				USER.BYTES for writing of feedback memory	—
34B2h	0	U8		RO	no	Number of entries	—
34B2h	1	U8		RW	no	FB1.USERBYTE1	FB1.USERBYTE1
34B2h	2	U8		RW	no	FB1.USERBYTE2	FB1.USERBYTE2
34B2h	3	U8		RW	no	FB1.USERBYTE3	FB1.USERBYTE3
34B2h	4	U8		RW	no	FB1.USERBYTE4	FB1.USERBYTE4
34B2h	5	U8		RW	no	FB1.USERBYTE5	FB1.USERBYTE5
34B2h	6	U8		RW	no	FB1.USERBYTE6	FB1.USERBYTE6
34B2h	7	U8		RW	no	FB1.USERBYTE7	FB1.USERBYTE7
34B2h	8	U8		RW	no	FB1.USERBYTE8	FB1.USERBYTE8
3501h	0	INT32	1:1	RW	no	Acceleration ramp	DRV.ACC, also see "6083h" (→ p. 78)
3502h	0	INT32	1:1	RW	no	Acceleration ramp for homing/jog modes	HOME.ACC
3506h	0	INT32			no	Action that hardware enable digital input will perform.	DRV.HWENMODE
3522h	0	INT32	1:1	RW	no	Deceleration rate	DRV.DEC, also see "6084h" (→ p. 78)
3524h	0	INT32	1:1	RW	no	Deceleration ramp for homing/jog modes	HOME.DEC
352Ah	0	INT32		RW	no	Direction of movements	DRV.DIR
3533h	0	U32		RO	no	Resolution of motor encoder	FB1.ENCRESES
353Bh	0	INT32		RO	no	Selection of the feedback type	FB1.SELECT
3542h	0	U32	1000:1	RW	no	Position Control Loop: Proportional Gain	PL.KP

Index	Sub-index	Data Type	Float Scale	Access	PDO map.	Description	ASCII object
3548h	0	U32	1000:1	RW	no	Velocity Control Loop: Proportional Gain	VL.KP
354Bh	0	INT32	1000:1	RW	no	Sets the velocity loop velocity feedforward gain value	VL.KVFF
354Dh	0	INT32	1000:1	RW	no	Velocity Control Loop: I-Integration Time	VL.KI
3558h	0	INT32	1000:1	RO	no	Current Monitor	IL.FB
3559h	0	INT32	1000:1	RO	no	Drive Ifold	IL.DIFOLD
355Ah	0	INT32	1000:1	RW	no	I2T Warning	IL.FOLDWTHRESH
3562h	0	INT32		RW	no	Function of Digital Input 1	DIN1.MODE
3565h	0	INT32		RW	no	Function of Digital Input 2	DIN2.MODE
3568h	0	INT32		RW	no	Function of Digital Input 3	DIN3.MODE
356Eh	0	INT32	1000:1	RW	no	Application Peak Current, positive direction	IL.LIMITP
356Fh	0	INT32	1000:1	RW	no	Application Peak Current, negative direction	IL.LIMITN
3586h	0	U32		RW	no	Sets the motor temperature fault level	MOTOR.TEMPFALT
3587h	0	INT32		RW	no	Select Motor Holding Brake	MOTOR.BRAKE
358Eh	0	U32	1000:1	RW	no	Motor Continuous Current Rating	MOTOR.ICONT
358Fh	0	U32	1000:1	RW	no	Motor Peak Current Rating	MOTOR.IPEAK
3593h	0	U32	1000:1	RW	no	Sets the torque constant of the motor	MOTOR.KT
3596h	0	U32	1000:1	RO	no	Sets the proportional gain of the d-component current PI-regulator as a percentage of IL.KP	IL.KPDRATIO
3598h	0	INT32	1000:1	RW	no	Absolute Gain of Current Control loop	IL.KP
359Ch	0	U32		RW	no	Sets the motor phase.	MOTOR.PHASE
359Dh	0	U32		RW	no	Sets the number of motor poles	MOTOR.POLES
35A3h	0	U32		RW	no	Sets the maximum motor speed	MOTOR.VMAX
35A4h	0	INT32	1000:1	RW	no	Maximum motor current	IL.MIFOLD
35ABh	0	U32	1000:1	RW	no	Sets the motor inertia	MOTOR.INERTIA
35AFh	0	U32		RW	no	Sets the digital output 1 mode	DOUT1.MODE
35B4h	0	INT32		RW	no	Operating Mode	DRV.OPMODE
35B9h	0	INT32		RW	no	Control for Motion Task 0	MT.CNTL

Index	Sub-index	Data Type	Float Scale	Access	PDO map.	Description	ASCII object
35BCh	0	INT32		RW	no	Next Task Number for Motion Task 0	MT.MTNEXT
35C5h	0	INT32	1:1	RO	no	Actual Following Error	PL.ERR
35C6h	0	INT32	1:1	RW	no	In-Position Window	MT.TPOSWND
35C7h	0	INT32	1:1	RW	no	Max. Following Error	PL.ERRFTHRESH
35CAh	0	INT32		RW	no	Position Resolution (Numerator)	UNIT.PIN
35CBh	0	INT32		RW	no	Position Resolution (Denominator)	UNIT.POUT
35D2h	0	U32		RO	no	Mechanical Position	FB1.MECHPOS
35E2h	0	U32	1:1	RW	no	Sets the current limit during homing procedure to a mechanical stop	HOME.IPEAK
35EBh	0	INT32		WO	no	Save Data in EEPROM	DRV.NVSAVE
35F0h	0	INT32		WO	no	Set Reference Point	HOME.SET
35FEh	0	INT32		WO	no	Stop Motion Task	DRV.STOP
35FFh	0	U32		RW	no	Selects between disable immediately or stop and then disable	DRV.DISMODE
3610h	0	INT32		RO	no	Ambient Temperature	DRV.TEMPERATURES
3611h	0	INT32		RO	no	Heat Sink Temperature	DRV.TEMPERATURES
3612h	0	INT32		RO	no	Motor Temperature	MOTOR.TEMP
3617h	0	U32	1:1	RW	no	Undervoltage mode	VBUS.UVMODE
3618h	0	INT32	1:1	RO	no	Actual Velocity	VL.FB
361Ah	0	INT32		RO	no	DC-bus voltage	VBUS.VALUE
361Dh	0	U32	1000:1	RW	no	Voltage level for undervoltage fault	VBUS.UVFTHRESH
3622h	0	INT32	1:1	RW	no	Max. Velocity	VL.LIMITP
3623h	0	INT32	1:1	RW	no	Max. Negative Velocity	VL.LIMITN
3627h	0	INT32	1:1	RW	no	Overspeed	VL.THRESH
3656h	0	U64	1:1	RW	no	Initial feedback position	FB1.ORIGIN
3659h	0	INT32		RW	no	Type of acceleration setpoint for the system	UNIT.ACCROTARY
365Bh	0	INT32		RW	no	Presetting for motion task that is processed later	MT.NUM
365Fh	0	INT32		RW	no	Systemwide Definition of Velocity/Speed	UNIT.VROTARY
3660h	0	INT32		RW	no	Set Resolution of the Position	UNIT.PROTARY
366Eh	0	INT32		RW	no	Disable Delaytime with Holding Brake	MOTOR.TBRAKEAPP
366Fh	0	INT32		RW	no	Enable Delaytime with Holding Brake	MOTOR.TBRAKERLS
3683h	0	U16		RW	no	Delay for wake and shake timing	WS.TDELAY1

Index	Sub-index	Data Type	Float Scale	Access	PDO map.	Description	ASCII object
3685h	0	U16		RW	no	Sets delay for wake and shake timing	WS.TDELAY2
36D0h	0	U16		RW	no	Sets wake and shake current-vector appliance time	WS.T
36D1h	0	U32	1:1	RW	no	Sets the minimum movement required for wake and shake	WS.DISTMIN
36D7h	0	U32	1000:1	RW	no	Sets homing auto move flag	HOME.AUTOMOVE
36E2h	0	U8		RW	no	Sets the number of repetitions for wake and shake	WS.NUMLOOPS
36E5h	0	U32		RW	no	CAN baud rate selection	FBUS.PARAM01
36E6h	0	U32		RW	no	pll synchronization	FBUS.PARAM02
36E7h	0	U32		RW	no	-	FBUS.PARAM03
36E8h	0	U32		RW	no	SYNC surveillance	FBUS.PARAM04
36E9h	0	U32		RW	no	-	FBUS.PARAM05
36EAh	0	U32		RW	no	-	FBUS.PARAM06
36EBh	0	U32		RW	no	-	FBUS.PARAM07
36ECh	0	U32		RW	no	-	FBUS.PARAM08
36EDh	0	U32		RW	no	-	FBUS.PARAM09
36EEh	0	U32		RW	no	-	FBUS.PARAM10
3856h	0	INT32	1:1	RW	no	velocity window for profile position mode	MT.TVELWND

Objects 5000h to 5999h

Index	Sub-index	Data Type	Float Scale	Access	PDO map.	Description	ASCII object
5013h	0	UINT32		RW	no	Controls how often the excitation is updated.	BODE.EXCITEGAP
5015h	0	UINT32		RW	no	Current command value used during the Bode procedure.	BODE.IAMP
5016h	0	UINT32		RW	no	Sets whether the excitation uses current or velocity excitation type.	BODE.INJECTPOINT
5019h	0	UINT32		RW	no	Length of the PRB signal before it repeats.	BODE.PRBDDEPTH
5080h	0	UINT32		RW	no	Default state of the software enable.	DRV.ENDEFAULT
5083h	0	UINT32		RW	no	Continuous rated current value.	DRV.ICONT
5084h	0	UINT32		RW	no	Peak rated current value.	DRV.IPEAK
5085h	0	UINT32		RW	no	Current that will be used during the DRV.ZERO procedure.	DRV.IZERO

Index	Sub-index	Data Type	Float Scale	Access	PDO map.	Description	ASCII object
508Ch	0	UINT32		RW	no	Number of Biss Sensor (Position) Bits for the BiSS Mode C encoder in use.	FB1.BISSBITS
508Fh	0	UINT32		RW	no	Initial feedback value as signed or unsigned.	FB1.INITSIGNED
5096h	0	UINT32		RW	no	Current value used during the phase finding procedure (PFB.PFIND=1)	FB1.PFINDCMDU
5097h	0	UINT32		RW	no	Number of feedback poles.	FB1.POLES
5099h	0	UINT32		RW	no	Resolver nominal transformation ratio.	FB1.RESKTR
509Ah	0	UINT32		RW	no	Electrical degrees of phase lag in the resolver.	FB1.RESREFPHASE
509Ch	0	UINT32		RW	no	Controls tracking calibration algorithm.	FB1.TRACKINGCAL
50B1h	0	UINT32		RW	no	Number of successful synchronized cycles needed to lock the PLL.	FBUS.PLLTHRESH
50C5h	0	UINT32		RW	no	Homing direction	HOME.DIR
50CBh	0	UINT32		RW	no	Homing mode	HOME.MODE
50E2h	0	UINT32		RW	no	Current loops fieldbus injected feed-forward gain	IL.KBUSFF
50FBh	0	UINT32		RW	no	Motor pitch.	MOTOR.PITCH
50FEh	0	UINT32		RW	no	Type of thermal resistor inside the motor.	MOTOR.RTYPE
5104h	0	UINT32		RW	no	Motor type.	MOTOR.TYPE
510Eh	0	UINT32		RW	no	Motion task to be triggered after an emergency stop procedure; active in opmode 2 (position) only.	MT.EMERGMT
5121h	0	UINT32		RW	no	Type of following error warning and fault usage.	PL.ERRMODE
5175h	0	UINT32		RW	no	Service motion current 1; active in opmode 0 (torque) only.	SM.I1
5176h	0	UINT32		RW	no	Service motion current 2; active in opmode 0 (torque) only.	SM.I2
5177h	0	UINT32		RW	no	Service motion mode.	SM.MODE
5179h	0	UINT32		RW	no	Service motion time 1.	SM.T1
517Ah	0	UINT32		RW	no	Service motion time 2.	SM.T2
517Eh	0	UINT32		RW	no	Enables and disables software travel limit switches.	SWLS.EN

Index	Sub-index	Data Type	Float Scale	Access	PDO map.	Description	ASCII object
5184h	0	UINT32		RW	no	Linear acceleration/deceleration units.	UNIT.ACCLINEAR
5187h	0	UINT32		RW	no	Linear position units.	UNIT.PLINEAR
518Ah	0	UINT32		RW	no	Linear velocity units.	UNIT.VLINEAR
518Eh	0	UINT32		RW	no	Voltage level for over voltage warning.	VBUS.OVWTHRESH
51B0h	0	UINT32		RW	no	Mode of velocity generation (Observer, d/dt); active in opmodes 1 (velocity) and 2 (position) only.	VL.GENMODE
51B3h	0	UINT32		RW	no	Scales the observer velocity signal; active in opmodes 1 (velocity) and 2 (position) only.	VL.KO
51B8h	0	UINT32		RW	no	Ratio of the estimated load moment of inertia relative to the motor moment of inertia; active in opmodes 1 and 2 only.	VL.LMJR
51BAh	0	UINT32		RW	no	Bandwidth of the observer in Hz.	VL.OBSBW
51BBh	0	UINT32		RW	no	Observer operating mode.	VL.OBSMODE
51CBh	0	UINT32		RW	no	Filter mode for Digital In 1.	DIN1.FILTER
51CCh	0	UINT32		RW	no	Filter mode for Digital In 2.	DIN2.FILTER
51CDh	0	UINT32		RW	no	Filter mode for Digital In 3.	DIN3.FILTER
51EFh	0	UINT32		RW	no	Brake apply timeout for vertical axis.	MOTOR.TBRAKETO
5259h	0	UINT32		RW	no	Fault Action for Fault 130.	FAULT130.ACTION
525Ah	0	UINT32		RW	no	Fault Action for Fault 131.	FAULT131.ACTION
525Bh	0	UINT32		RW	no	Fault Action for Fault 132.	FAULT132.ACTION
525Ch	0	UINT32		RW	no	Fault Action for Fault 133.	FAULT134.ACTION
525Dh	0	UINT32		RW	no	Fault Action for Fault 702.	FAULT702.ACTION
525Eh	0	UINT32		RW	no	Method of acquiring IP Address.	IP.MODE
525Fh	0	UINT32		RW	no	Load inertia.	LOAD.INERTIA
5260h	0	UINT32		RW	no	Motor back EMF constant.	MOTOR.KE

Index	Sub-index	Data Type	Float Scale	Access	PDO map.	Description	ASCII object
5261h	0	UINT32		RW	no	Changing voltage thresholds for HV and MV Drives	VBUS.HALFVOLT
5263h	0	UINT32		RW	no	Feedback for handwheel operation.	DRV.HANDWHEELSRC
5264h	0	UINT32		RW	no	Delay time between inactive Hardware Enable input and drive disable.	DRV.HWENDELAY
5265h	0	UINT32		RW	no	Index into the Current Loop Gain Scheduling Table.	IL.KPLOOKUPINDEX
5266h	0	UINT32		RW	no	Value of the current loop gain scheduling index.	IL.KPLOOKUPVALUE
5267h	0	UINT32		RW	no	Fault Action for Fault 451.	FAULT451.ACTION
5268h	0	UINT32		RW	no	Brake Immediately in the case of a drive disable.	MOTOR.BRAKEIMM
5352h	0	UINT16		RW	no	Amount of time a communication error must be present before an W&S-fault is thrown.	WS.CHECKT
535Ch	0	UINT16		RW	no	Sets the calming time of the motor for Wake & Shake mode 1.	WS.TSTANDSTILL
535Dh	0	UINT16		RW	no	Time for the ramp up current in Wake & Shake mode 1.	WS.TIRAMP
5360h	0	UINT16		RW	no	Rotor time constant.	MOTOR.IMTR
5362h	0	UINT32		RW	no	The direct-axis current set point used for induction machine closed-loop control.	MOTOR.IMID

5.3.4 Profile specific SDOs

Index	Sub-index	Data Type	Float Scale	Access	PDO map.	Description	ASCII object
6040h	0	U16		WO	yes	Control word	—
6041h	0	U16		RO	yes	Status word	—
6060h	0	INT8		RW	yes	Modes of Operation	—
6061h	0	INT8		RO	yes	Modes of Operation Display	—
6063h	0	INT32		RO	yes	Position actual value (increments)	—
6064h	0	INT32	1:1	RO	yes	Position actual value (position units)	PL.FB
6065h	0	U32	1:1	RW	no	Following error window	PL.ERRFTHRESH
606Bh	0	INT32	1:1	RO	no	Velocity demand value	VL.CMD

Index	Sub-index	Data Type	Float Scale	Access	PDO map.	Description	ASCII object
606Ch	0	INT32	1000:1	RO	yes	Velocity actual value (PDO in RPM)	VL.FB
606Dh	0	U16		RW	yes	Velocity window	
606Eh	0	U16		RW	yes	Velocity window time	
6071h	0	INT16		RW	yes	Target torque	—
6072h	0	U16		RW	yes	Max torque	—
6073h	0	U16		RW	no	Max current	
6077h	0	INT16		RO	yes	Torque actual value	—
607Ah	0	INT32	1:1	RW	yes	Target position	MT.P
607Ch	0	INT32	1:1	RW	no	Reference offset	HOME.P
607Dh		ARRAY				Software position limit	
607Dh	0	U8		RO	no	Number of entries	
607Dh	1	INT32	1:1	RW	no	Software position limit 1	SWLS.LIMIT0
607Dh	2	INT32	1:1	RW	no	Software position limit 2	SWLS.LIMIT1
6081h	0	U32	1:1	RW	yes	Profile Velocity	MT.V
6083h	0	U32	1:1	RW	yes	Profile Acceleration	MT.ACC , DRV.ACC
6084h	0	U32	1:1	RW	yes	Profile Deceleration	MT.DEC , DRV.DEC
608Fh		ARRAY				Position encoder resolution	—
608Fh	0	U8		RO	no	Number of entries	—
608Fh	1	U32		RW	no	Encoder increments	—
608Fh	2	U32		RW	no	Motor revolutions	
6091h		ARRAY				Gear ratio	—
6091h	0	U8		RO	no	Number of entries	—
6091h	1	U32		RW	no	Motor revolution	
6091h	2	U32		RW	no	Shaft revolutions	
6092h		ARRAY				Feed constant	—
6092h	0	U8		RO	no	Number of entries	—
6092h	1	U32		RW	no	Feed	UNIT.PIN
6092h	2	U32		RW	no	Shaft revolutions	—
6098h	0	INT8		RW	no	Homing type	HOME.MODE , HOME.DIR
6099h		ARRAY				Homing velocity	—
6099h	0	U8		RO	no	Number of entries	—
6099h	1	U32	1:1	RW	no	Speed while searching for limit switch	HOME.V
6099h	2	U32		RW	no	Speed while searching for zero mark	HOME. FEEDRATE
609Ah	0	U32	1:1	RW	no	Homing acceleration	HOME.ACC , HOME.DEC
60B1h	0	INT32	1:1	RW	yes	Velocity offset	VL.BUSFF
60B2h	0	INT16		RW	yes	Torque offset (PDO only)	
60B8h	0	U16		RW	yes	Touch probe function	—
60B9h	0	U16		RW	yes	Touch probe status	—

Index	Sub-index	Data Type	Float Scale	Access	PDO map.	Description	ASCII object
60BAh	0	INT32		RW	yes	Touch probe 1 positive edge	—
60BBh	0	INT32		RW	yes	Touch probe 1 negative edge	—
60BCh	0	INT32		RW	yes	Touch probe 2 positive edge	—
60BDh	0	INT32		RW	yes	Touch probe 2 negative edge	—
60C0h	0	INT16		RW	no	Interpolation submode select	—
60C1h		ARRAY				Interpolation data record	—
60C1h	0	U8		RO	no	Number of entries	—
60C1h	1	INT32		RW	yes	Interpolation target position	—
60C1h	2	U32		RW	yes	Interpolation time	—
60C1h	3	INT32		RW	yes	Interpolation target velocity	—
60C2h		RECORD				Interpolation time period	—
60C2h	0	U8		RO	no	Number of entries	FBUS. SAMPLEPERIOD
60C2h	1	U8		RW	no	Interpolation time units	—
60C2h	2	INT16		RW	no	Interpolation time index	—
60C4h		RECORD				Interpolation data configuration	—
60C4h	0	U8		RO	no	Number of entries	—
60C4h	1	U32		RO	no	Maximum buffer size	—
60C4h	2	U32		RO	yes	Actual buffer size	—
60C4h	3	U8		RW	no	Buffer organization	—
60C4h	4	U16		RW	no	Buffer position	—
60C4h	5	U8		WO	no	Size of data record	—
60C4h	6	U8		WO	no	Buffer clear	—
60D0h		ARRAY				Touch probe source	—
60D0h	0	U8		RO	no	Highest sub-index supported	-
60D0h	1	INT16		RW	no	Touch probe 1 source	—
60D0h	2	INT16		RW	no	Touch probe 2 source	—
60F4h	0	INT32		RO	yes	Following error actual value	PL.ERR
60FDh	0	U32		RO	yes	Digital inputs	DIN1.MODE TO DIN3.MODE
60FEh		ARRAY				Digital outputs	
60FEh	0	U8		RO	no	Number of entries	
60FEh	1	U32		RW	yes	Physical outputs	
60FEh	2	U32		RW	no	Bit mask	
60FFh	0	INT32	1000:1	RW	yes	Target velocity	VL.CMDU
6502h	0	U32		RO	no	Supported drive modes	—

5.4 Object descriptions

The objects in this section are sorted by object number.

5.4.1 Object 1000h: Device Type (DS301)

This object describes the device type (servo drive) and device functionality (DS402 drive profile). Definition:

MSB				LSB	
Additional information			Device profile number		
Mode bits		Type		402d=192h	
31	24	23	16	15	0

The device profile number is DS402, the type is 2 for drives, the mode bits 28 to 31 are manufacturer specific and may be changed from its actual value of 0. A read access delivers 0x00020192 at the moment.

Index	1000h
Name	device type
Object code	VAR
Data type	UNSIGNED32
Category	mandatory
Access	R/O
PDO mapping	not possible
Value range	UNSIGNED32
Default value	no

5.4.2 Object 1001h: Error register (DS301)

This object is an error register for the device. The device can map internal errors into this byte. It is a part of an Emergency object.

Index	1001h
Name	Error register
Object code	VAR
Data type	UNSIGNED8
Category	mandatory
Access	R/O
PDO mapping	not possible
Value range	UNSIGNED8
Default value	no

Error reasons to be signaled: If a bit is set to 1 the specified error has occurred. The generic error is signaled at any error situation.

Bit	Description	Bit	Description
0	generic error	4	communication error (overrun, error state)
1	current	5	device profile specific
2	voltage	6	reserved (always 0)
3	temperature	7	manufacturer specific

5.4.3 Object 1002h: Manufacturer Status Register (DS301)

The manufacturer status register contains important drive informations.

Index	1002h
Name	Manufacturer Status Register
Object code	VAR
Data type	UNSIGNED32
Category	optional
Access	R/O
PDO mapping	possible
Value range	UNSIGNED32
Default value	no

The following table shows the bit assignment for the status register:

Bit	Description	Bit	Description
0	1 = Movement (positioning, homing) active	16	1 = Homing move active
1	reference position set	17	reserved
2	1 = reference switch high (home-position)	18	reserved
3	1 = In Position	19	1 = Emergency stop active
4	reserved	20	reserved
5	reserved	21	reserved
6	reserved	22	reserved
7	Active Disabel activated	23	1 = Homing move finished
8	Warning active	24	Power stage deactivating
9	1 = target velocity reached (pp- or pv-Mode)	25	1 = digital input 1 set
10	reserved	26	1 = digital input 2 set
11	1 = Homing error	27	1 = digital input 3 set
12	reserved	28	1 = digital input 4 set
13	1 = Safe Torque Off selected	29	1 = digital input hardware enable set
14	1 = Power stage enabled	30	1 = Wake and Shake action is required
15	1 = Error state	31	Braking, 1 = set points not accepted

5.4.4 Object 1003h: Predefined Error Field (DS301)

The object 1003h provides an error history with a maximum size of 10 entries.

Subindex 0 contains the number of errors which have occurred since the last reset of the error history, either by startup of the drive or resetting the error history by writing 0 to subindex 0.

A new Emergency-message is written into subindex 1 shifting the old entries one subindex higher. The old content of subindex 8 is lost.

The UNSIGNED32-information written to the subindexes is defined in the field Error Code in the description of the Emergency Messages (→ p. 53).

Index	1003h
Name	pre-defined Error Field
Object code	ARRAY
Data type	UNSIGNED32
Category	optional
Subindex	0
Description	Number of entries
Data type	UNSIGNED8
Category	mandatory
Access	R/W
PDO mapping	not possible
Value range	0 to 10
Default value	0
Subindex	1 to 10
Description	Standard error field (→ p. 53)
Category	optional
Access	R/O
PDO mapping	not possible
Value range	UNSIGNED32
Default value	no

5.4.5 Object 1005h: COB-ID of the SYNC Message (DS301)

This object defines the COB-Id of the synchronisation object (SYNC).

Index	1005h
Name	COB-ID for the SYNC message
Object code	VAR
Data type	UNSIGNED32
Category	conditional
Access	R/W
PDO mapping	not possible
Value range	UNSIGNED32
Default value	0x80

Bit coded information:

Bit	Value	Meaning
31 (MSB)	X	—
30	0	Device not generate SYNC message
	1	Device generates SYNC message
29	0	11 Bit ID (CAN 2.0A)
	1	29 Bit ID (CAN 2.0B)
28 to 11	X	—
	0	if Bit 29=0
10 to 0 (LSB)	X	Bit 0 to 10 of SYNC COB-ID

The device does not support the generation of SYNC-messages and only the 11-bit IDs. So the bits 11 to 30 are always 0.

5.4.6 Object 1006h: Communication Cycle Period (DS301)

This object can be used to define the period (in μs) for the transmission of the SYNC telegram.

Index	1006h
Name	Period of the communication cycle
Object code	VAR
Data type	UNSIGNED32
Category	O
Access	R/W
PDO mapping	not possible
Value range	UNSIGNED32
Default value	00h

5.4.7 Object 1008h: Manufacturer Device Name (DS301)

The device name consists of four ASCII characters in the form Yzzz, whereby Y stands for the mains voltage (L, M, H or U, e.g. H for High Voltage) zzz stands for the power stage current.

Index	1008h
Name	Manufacturer Device Name
Object code	VAR
Data type	Visible String
Category	Optional
Access	const
PDO mapping	not possible
Value range	
Default value	no

5.4.8 Object 1009h: Manufacturer Hardware Version

This object will be supported in the future.

Index	1009h
Name	manufacturer hardware version
Object code	VAR
Data type	Visible String
Category	Optional
Access	const
PDO mapping	not possible
Value range	-
Default value	no

5.4.9 Object 100Ah: Manufacturer Software Version (DS301)

The object contains the manufacturer software version (here: the CANopen-part of the drive firmware).

Index	100Ah
Name	Manufacturer Software Version
Object code	VAR
Data type	Visible String
Category	Optional
Access	const
PDO mapping	not possible
Value range	0.01 to 9.99
Default value	no

5.4.10 Object 100Ch: Guard Time (DS301) Response monitoring

The arithmetical product of the Objects 100Ch Guard Time and 100Dh Lifetime Factor is the response monitoring time. The Guard Time is given in milliseconds. The response monitoring is activated with the first Nodeguard object. If the value of the object Guard Time is set to zero, then the response monitoring is inactive.

Index	100Ch
Name	Guard Time
Object code	VAR
Data type	UNSIGNED16
Category	conditional; mandatory, if heartbeat not supported
Access	R/W
PDO mapping	not possible
Value range	UNSIGNED16
Default value	0

5.4.11 Object 100Dh: Lifetime Factor (DS301)

The product of Guard Time and Life Time Factor gives the life time for the nodeguarding protocol. If it's 0, the protocol is not used.

Index	100Dh
Name	Lifetime Factor
Object code	VAR
Data type	UNSIGNED8
Category	conditional; (mandatory, if heartbeat not supported)
Access	R/W
PDO mapping	not possible
Value range	UNSIGNED8
Default value	0

5.4.12 Object 1010h: Store Parameters (DS301)

This object supports the saving of parameters to a flash EEPROM. Only the subindex 1 for saving of all parameters, which can also be saved in the parameter files via the GUI, is supported.

Index	1010h
Name	store parameters (DRV.NVSAVE)
Object code	ARRAY
Data type	UNSIGNED32
Category	optional
Subindex	0
Name	number of entries
Object code	VAR
Data type	UNSIGNED8
Category	mandatory
Access	R/O
PDO Mapping	not possible
Value range	1
Default value	1
Subindex	1
Name	save all parameters
Object code	VAR
Data type	UNSIGNED32
Category	mandatory
Access	R/W
PDO Mapping	not possible
Value range	UNSIGNED32
Default value	1

Data definition:

Bit	Value	Meaning
31 to 2	0	reserved (=0)
1	0	Device does not save parameters autonomously
	1	Device does save parameters autonomously
0	0	Device does not save parameters on command
	1	Device does save parameters on command

By read access to subindex 1 the drive provides information about its storage functionality.

This drive provides a constant value of 1 by read access, i.e. all parameters can be saved by writing to Object 1010 sub 1. In general the drive does not save parameters autonomously with the exception of e.g. the special treatment of the homing of multiturn absolute encoders.

Storing of parameters is only done if a special signature ("save") is written to subindex 1.

"save" is equivalent to the unsigned32 - number 65766173h.

5.4.13 Object 1011h: Restore Default Parameters DS301

With this object the default values of parameters according to the communication or device profile are restored. The AKD gives the possibility to restore all default values.

Index	1011h
Name	restore default parameters
Object code	ARRAY
Data type	UNSIGNED32
Category	optional
Subindex	0
Name	number of entries
Object code	VAR
Data type	UNSIGNED8
Category	mandatory
Access	R/O
PDO Mapping	not possible
Value range	1
Default value	1
Subindex	1
Name	restore all default parameters (DRV.RSTVAR)
Object code	VAR
Data type	UNSIGNED32
Category	mandatory
Access	R/W
PDO Mapping	not possible
Value range	UNSIGNED32
Default value	1 (device restores parameter)

Restoring default parameters to the RAM will be done, if a special signature ("load") is written to subindex 1. "load" has to be transmitted as unsigned32 - number 64616F6Ch.

5.4.14 Object 1012h: COB-ID of the Time Stamp (DS301)

This object defines the COB-ID of the time stamp.

Index	1012h
Name	COB-ID for the time stamp
Object code	VAR
Data type	UNSIGNED32
Category	optional
Access	R/W
PDO mapping	not possible
Value range	UNSIGNED32
Default value	100h

Bit coded information:

Bit	Content	Value	Meaning
31 (MSB)	consume	0	Drive does not consume time message
		1	Drive does consume time message
30	produce	0	Drive does not produce time message
		1	Drive does produce time message
29	frame	0	Value fixed to 0
28 to 11	reserved	–	reserved
10 to 0 (LSB)	CAN-ID	0h - 800h	COB-ID of the time stamp

5.4.15 Object 1014h: COB-ID for Emergency Message (DS301)

This object defines the COB-ID of the Emergency message.

Index	1014h
Name	COB-ID emergency message
Object code	VAR
Data type	UNSIGNED32
Category	conditional; mandatory, if Emergency is supported
Access	R/O
PDO mapping	not possible
Value range	UNSIGNED32
Default value	80h + Node - ID

5.4.16 Object 1016h: Consumer Heartbeat Time

The consumer heartbeat time defines the expected heartbeat cycle time (ms) and must be higher than the corresponding producer heartbeat time configured on the device producing this heartbeat. Monitoring starts after the reception of the first heartbeat. If the consumer heartbeat time is 0 ms the corresponding entry is not used.

Index	1016h
Name	consumer heartbeat time
Object code	ARRAY
Data type	UNSIGNED32
Category	optional
Subindex	0
Description	number of entries
Data type	UNSIGNED8
Category	mandatory
Access	R/O
PDO Mapping	not possible
Value range	1
Default value	1
Subindex	1
Description	Consumer heartbeat time
Category	mandatory
Access	R/W
PDO Mapping	not possible
Value range	unsigned 32
Default value	0

Definition of the entry value of Subindex 1

	MSB				LSB
Value	reserved (value: 00)		Node-ID		heartbeat time
Encoded as	-		UNSIGNED8		UNSIGNED16
Bit	31	24	23	16	15 0

5.4.17 Object 1017h: Producer Heartbeat Time

The producer heartbeat time defines the cycle time of the heartbeat in ms. If it's 0, it is not used.

Index	1017h
Name	Producer heartbeat time
Object code	VAR
Data type	UNSIGNED16
Category	conditional; mandatory, if guarding is not supported
Access	R/W
PDO mapping	not possible
Value range	UNSIGNED16
Default value	0

5.4.18 Object 1018h: Identity Object (DS301)

The Identity Object contains general device information.

Index	1018h
Name	Identity Object
Object code	RECORD
Data type	Identity
Category	mandatory
Subindex	0
Description	Number of entries
Data type	UNSIGNED8
Category	mandatory
Access	R/O
PDO mapping	not possible
Value range	1 to 4
Default value	4

Subindex 1 is a unique number for a device manufacturer.

Subindex	1
Description	Vendor ID
Category	mandatory
Access	R/O
PDO mapping	not possible
Value range	UNSIGNED32
Default value	0x6Ah (Kollmorgen)

Subindex 2 contains four ASCII - characters, which determine the voltage range and current class of the device. The voltage range is one character L, M or H for low, medium and high voltage. The next three characters are showing the continuous current of the drive.

Subindex	2
Description	Product Code
Category	optional
Access	R/O
PDO mapping	not possible
Value range	e.g. M006 for an MV6 drive
Default value	no

Subindex 3 consists of two revision numbers:

- the major revision number in the upper word containing the CAN-version
- the minor revision number is not used in the AKD. The firmware version can be retrieved as a string via object 0x100A or as numbers via object 0x2018 subindex 1 to 4.

E.g. a value of 0x0014 0000 means CAN-version 0.20.

Subindex	3
Description	Revision Number
Category	optional
Access	R/O
PDO mapping	not possible
Value range	UNSIGNED32
Default value	no

Subindex 4 gives the serial number of the drive. This number contains the following information in it:

- bits 0..14: Board serial number (production in week of year)
- bits 15..20: week of production
- bits 21..24: year of production - 2009
- bits 25..31: ASCII-code of MFR-ID

Subindex	4
Description	Serial Number
Category	optional
Access	R/O
PDO mapping	not possible
Value range	UNSIGNED32
Default value	no

5.4.19 Object 1026h: OS Prompt

The OS prompt is used to build up an ASCII - communication channel to the drive.

Index	1026h
Name	OS Prompt
Object code	ARRAY
Data type	UNSIGNED8
Category	optional

Subindex	0
Description	Number of entries
Data type	UNSIGNED8
Category	mandatory
Access	R/O
PDO mapping	not possible
Value range	2
Default value	2

Subindex 1 is used to send one character to the drive.

Subindex	1
Description	StdIn
Category	mandatory
Access	W
PDO mapping	not possible
Value range	UNSIGNED8
Default value	—

Subindex 2 is used to receive one character from the drive.

Subindex	2
Description	StdOut
Category	mandatory
Access	R/O
PDO mapping	not possible
Value range	UNSIGNED8
Default value	0

5.4.20 Objects 1400-1403h: 1st - 4th RXPDO communication parameter (DS301)

1400h to 1403h for RXPDO 1 to 4

Index	1400h 1401h 1402h 1403h
Name	receive PDO parameter
Object code	RECORD
Data type	PDO CommPar
Category	mandatory

Defined sub-indices

Subindex	0
Name	number of entries
Data type	UNSIGNED8
Category	mandatory
Access	R/O
PDO Mapping	not possible
Value Range	2
Default Value	2

Subindex	1
Name	COB-ID used by PDO
Category	mandatory
Access	R/W
PDO Mapping	not possible
Value Range	UNSIGNED32
Default Value	Index 1400h: 200h + Node-ID Index 1401h: 300h + Node-ID Index 1402h: 400h + Node-ID Index 1403h: 500h + Node-ID

Subindex 1 contains the COB-Id of the PDO as a bit coded information:

Bit	Value	Meaning
31	0	PDO exists/is valid
	1	PDO does not exist/is not valid
30	0	RTR allowed on this PDO, not to be used (Can in Automation organisation)
	1	RTR not allowed on this PDO
29	0	11 bit-ID (CAN 2.0A)
	1	29 bit-ID (CAN 2.0B), not supported
28 to 11	X	Identifier-bits with 29 bit-ID, not relevant
10 to 0	X	Bits 10-0 of COB-ID

Subindex	2
Name	transmission type
Category	mandatory
Access	R/W
PDO Mapping	not possible
Value Range	UNSIGNED8
Default Value	FFh

Subindex 2 contains the transmission type of the PDO. There are two ways of setting:

- the value FFh or 255 for event-triggered PDO, which is directly interpreted by reception and taken into actions,
- values from 0 to 240, which cause a SYNC-telegram-controlled interpretation of the PDO contents. Values of 1 to 240 mean, that 0 to 239 SYNC-telegrams are ignored, before one is interpreted. The value 0 means, that only the next SYNC-telegram is interpreted.

5.4.21 Objects 1600-1603h: 1st - 4th RXPDO mapping parameter (DS301)

1600h to 1603h for RXPDO 1 to 4.

Index	1600h 1601h 1602h 1603h
Name	receive PDO mapping
Object Code	RECORD
Data Type	PDO Mapping
Category	mandatory
Subindex	0
Name	number of entries
Data type	UNSIGNED8
Category	mandatory
Access	R/W
PDO Mapping	not possible
Value Range	0: PDO is not active 1 - 8: PDO activated, mappings are taken only byte-wise
Default Value	PDO1: 1 PDO2: 2 PDO3: 2 PDO4: 2
Subindex	1 - 8
Name	PDO - mapping for the n-th application object
Category	Conditional, depends on number and size of object be mapped
Access	R/W
PDO Mapping	not possible
Value Range	UNSIGNED32
Default Value	See below

5.4.22 Objects 1800-1803h: 1st - 4th TXPDO communication parameter (DS301)

1800h to 1803h for TXPDO 1 to 4.

Index	1800h 1801h 1802h 1803h
Name	transmit PDO parameter
Object code	RECORD
Data type	PDO CommPar
Category	mandatory
Subindex	0
Name	number of entries
Data type	UNSIGNED8
Category	mandatory
Access	R/O
PDO Mapping	not possible
Value Range	5
Default Value	5
Subindex	1
Name	COB-ID used by PDO
Category	mandatory
Access	R/W
PDO Mapping	not possible
Value Range	UNSIGNED32
Default Value	Index 1800h: 180h + Node-ID Index 1801h: 280h + Node-ID Index 1802h: 380h + Node-ID Index 1803h: 480h + Node-ID
Subindex	2
Name	transmission type
Category	mandatory
Access	R/W
PDO Mapping	not possible
Value Range	UNSIGNED8
Default Value	FFh
Subindex	3
Name	inhibit time
Category	optional
Access	R/W
PDO Mapping	not possible
Value Range	UNSIGNED16 (n*1/10ms)
Default Value	0h

Subindex	4
Name	reserved
Category	optional
Access	R/W
PDO Mapping	not possible
Value Range	0
Default Value	0
Subindex	5
Name	event timer
Category	optional
Access	R/W
PDO Mapping	not possible
Value Range	UNSIGNED16 (0=not used, ms)
Default Value	0h

Subindex 1 contains the COB-Id of the PDO as a bit coded information:

Bit-Number	Value	Meaning
31	0	PDO exists/is valid
	1	PDO does not exist/is not valid
30	0	RTR allowed on this PDO, not supported
	1	RTR not allowed on this PDO, not supported
29	0	11 bit-ID (CAN 2.0A)
	1	29 bit-ID (CAN 2.0B), not supported
28 to 11	X	Identifier-bits with 29 bit-ID, not relevant
10 to 0	X	Bits 10-0 of COB-ID

Subindex 2 contains the transmission type of the PDO. There are two ways of setting:

- A value of FFh or 255d for an event-triggered PDO, which is sent immediately after a change in the mapped application objects. Setting of Subindex 3 or 5 has an influence on the sending of a PDO. With Subindex 3 you can configure, in which minimal time the so configured Transmit-PDOs are sent, if PDO-data contents change (reduction of bus-load). With Subindex 5 (event time) a timer is used, which is reset with every event-triggered sending of this PDO. If there is no change of the PDO-content in this time, the PDO is sent caused by this timer event.
- Values from 0 to 240 cause a SYNC-Telegram controlled sending of the PDO. Values from 1 to 240 define how often the SYNC-telegram leads to a sending of a PDO. The value 0 means, that only the next SYNC-telegram leads to a sending of the so configured PDOs.

5.4.23 Objects 1A00-1A03h: 1st - 4th TXPDO mapping parameter (DS301)

1A00h to 1A03h for TXPDO 1 to 4.

Index	1A00h 1A01h 1A02h 1A03h
Name	transmit PDO mapping
Object Code	RECORD
Data Type	PDO Mapping
Category	mandatory
Subindex	0
Name	number of mapped application objects in PDO
Data type	UNSIGNED8
Category	mandatory
Access	R/W
PDO Mapping	not possible
Value Range	0: PDO is not active 1 - 8: PDO activated, mappings are taken only byte-wise
Default Value	PDO1: 1 PDO2: 2 PDO3: 2 PDO4: 2
Subindex	1 - 8
Name	PDO - mapping for the n-th application object
Category	Conditional, depends on number and size of object be mapped
Access	R/W
PDO Mapping	not possible
Value Range	UNSIGNED32
Default Value	See below

5.4.24 Object 2000h: System Warnings

This object is used to show up to three actual warnings with their AKD- specific warning number.

Index	2000h
Name	System Warnings
Object code	ARRAY
Data type	UNSIGNED32
Subindex	0
Description	number of entries
Category	mandatory
Access	R/O
PDO mapping	not possible
Value range	3
Default value	3
Subindex	1 to 3
Description	DRV.WARNING1 to DRV.WARNINGS3
Mode	independent
Access	R/O
PDO mapping	not possible
Unit	—
Value range	0 to 999
Default value	0

5.4.25 Object 2001h: System Faults

This object is used to show up to ten actual faults with their AKD- specific fault number.

Index	2001h
Name	System Faults
Object code	ARRAY
Data type	UNSIGNED32
Subindex	0
Description	number of entries
Category	mandatory
Access	R/O
PDO mapping	not possible
Value range	0xA
Default value	0xA
Subindex	1 to A
Description	DRV.FAULT1 to DRV.FAULT10
Mode	independent
Access	R/O
PDO mapping	not possible
Unit	—
Value range	0 to 999
Default value	0

5.4.26 Object 2002h: Manufacturer status bytes

This objects delivers the information of the manufacturer status (object 0x1002 sub 0) as four separate, mappable, bytes.

Index	2002h
Name	Manufacturer status bytes
Object code	ARRAY
Data type	UNSIGNED8
Subindex	0
Description	number of entries
Category	mandatory
Access	R/O
PDO mapping	not possible
Value range	0x4
Default value	0x4
Subindex	1 to 4
Description	Manufacturer status byte 1 to Manufacturer status byte 4
Mode	independent
Access	R/O
PDO mapping	possible
Unit	—
Value range	0 to 0xFF
Default value	-

5.4.27 Object 2014-2017h: 1st-4th Mask 1 to 4 for Transmit-PDO

In order to reduce the bus loading with event-triggered PDOs, masking can be used to switch off the monitoring for individual bits in the PDO. In this way it can be arranged, for instance, that actual position values are only signaled once per turn.

This Object masks the PDO-channels 1 to 4. If only two bytes have been defined in a PDO, then it masks just two bytes, although 4 bytes of mask information have been transmitted.

An activated bit in the mask means that monitoring is active for the corresponding bit in the PDO.

Index	2014h 2015h 2016h 2017h
Name	tx_mask 1 to 4
Object code	ARRAY
Data type	UNSIGNED32
Subindex	1
Description	tx_mask1 to 4_low
Mode	independent
Access	R/W
PDO mapping	not possible
Unit	—
Value range	UNSIGNED32
Default value	FFFFFFFFh
Subindex	2
Description	tx_mask1 to 4_high
Mode	independent
Access	R/W
PDO mapping	not possible
Unit	—
Value range	UNSIGNED32
Default value	FFFFFFFFh

5.4.28 Object 2018h: Firmware Version

This object gives all information regarding the firmware version.

Example: Firmware version M_01_00_01_005 would show the numbers 1, 0, 1, 5 in the sub-indices 1 to 4.

Index	2018h
Name	firmware version
Object code	ARRAY
Data type	UNSIGNED16
Subindex	1
Description	major version
Mode	independent
Access	R/O
PDO mapping	not possible
Unit	—
Value range	UNSIGNED16
Default value	0
Subindex	2
Description	minor version
Mode	independent
Access	R/O
PDO mapping	not possible
Unit	—
Value range	UNSIGNED16
Default value	0
Subindex	3
Description	revision
Mode	independent
Access	R/O
PDO mapping	not possible
Unit	—
Value range	UNSIGNED16
Default value	0
Subindex	4
Description	branch revision
Mode	independent
Access	R/O
PDO mapping	not possible
Unit	—
Value range	UNSIGNED16
Default value	0

5.4.29 Object 2026h: ASCII Channel

This object is used to build up an ASCII - communication channel to the drive with 4-byte ASCII-strings.

Index	2026h
Name	ASCII Channel
Object code	ARRAY
Data type	Visible String
Category	optional

Subindex	0
Description	Number of entries
Data type	UNSIGNED8
Category	mandatory
Access	R/O
PDO mapping	not possible
Value range	2
Default value	2

Subindex 1 is used to send four ASCII-characters to the drive.

Subindex	1
Description	Command
Category	mandatory
Access	wo
PDO mapping	no
Value range	Visible String
Default value	—

Subindex 2 is used to receive four characters from the drive.

Subindex	2
Description	Response
Category	mandatory
Access	R/O
PDO mapping	no
Value range	Visible String
Default value	-

5.4.30 Object 204Ch: PV Scaling Factor

This object shall indicate the configured numerator and denominator of the pv scaling factor. The pv scaling factor serves to modify the resolution or directing range of the specified set-point. It is also included in calculation of the vl velocity demand, and vl velocity actual value. It does not influence the velocity limit function and the ramp function. The value shall have no physical unit and shall be given in the range from -32 768 to +32 767, but the value of 0 shall not be used.

The velocity scaling factor is only active, when bit 4 of FBUS.PARAM05 is set to 1. Otherwise velocities are scaled as 1/1000 rpm.

Index	204Ch
Name	pv scaling factor
Object code	ARRAY
Data type	INTEGER32
Category	optional
Subindex	0
Description	number of entries
Data type	UNSIGNED8
Category	mandatory
Access	R/O
PDO mapping	not possible
Value range	2
Default value	no
Subindex	1
Description	pv scaling factor numerator
Category	optional
Access	R/W
PDO mapping	not possible
Value range	INTEGER32
Default value	+1
Subindex	2
Description	pv scaling factor denominator
Category	optional
Access	R/W
PDO mapping	not possible
Value range	INTEGER32
Default value	+1

5.4.31 Object 2071h: Target Current

This parameter can be used alternatively to the DS402 parameter 6071h and is the input to the torque controller. The value is scaled in mA (milli Amperes).

Index	2071h
Name	Target current
Object code	VAR
Data type	INTEGER 32
Category	optional
Access	RW
PDO mapping	possible
Value range	depends on DRV.IPEAK and MOTOR.IPEAK
Default value	0

5.4.32 Object 2077h: Current Actual Value

This parameter can be used alternatively to the DS402 parameter 6077h. The value is scaled in mA (milli Amperes).

Index	2077h
Name	Current actual value
Object code	VAR
Data type	INTEGER 32
Category	optional
Access	RO
PDO mapping	possible
Value range	depends on DRV.IPEAK and MOTOR.IPEAK
Default value	0

5.4.33 Object 20A0h: Latch position 1, positive edge

This object is used to output the position or a time, depending on CAP0.MODE, at which the first positive edge occurred on a signal, which can be configured with CAP0.TRIGGER. The latch enable must be active for that purpose(see object 20A4 and 20A5). With CAP0.MODE = 3 the latched position of the encoder index pulse is transferred via this object.

Index	20A0h
Name	Latch position 1 positive edge CAP0.PLFB, Time capture CAP0.T
Object code	VAR
Data type	INTEGER32
Category	optional
Access	R/O
PDO mapping	possible
Value range	INTEGER32
Float scaling	var
Default value	0

5.4.34 Object 20A1h: Latch position 1, negative edge

This object is used to output the position or a time, depending on CAP0.MODE, at which the first negative edge occurred on a signal, which can be configured with CAP0.TRIGGER. The latch enable must be active for that purpose(see object 20A4 and 20A5).

Index	20A1h
Name	Latch position 1 negative edge CAP0.PLFB, Time capture CAP0.T
Object code	VAR
Data type	INTEGER32
Category	optional
Access	R/O
PDO mapping	possible
Value range	INTEGER32
Float scaling	var
Default value	0

5.4.35 Object 20A2h: Latch position 2, positive edge

This object is used to output the position or a time, depending on CAP1.MODE, at which the first positive edge occurred on a signal, which can be configured with CAP1.TRIGGER. The latch enable must be active for that purpose(see object 20A4 and 20A5).

Index	20A2h
Name	Latch position 2 positive edge CAP1.PLFB, Time capture CAP1.T
Object code	VAR
Data type	INTEGER32
Category	optional
Access	R/O
PDO mapping	possible
Value range	INTEGER32
Float scaling	var
Default value	0

5.4.36 Object 20A3h: Latch position 2, negative edge

This object is used to output the position or a time, depending on CAP1.MODE, at which the first negative edge occurred on a signal, which can be configured with CAP1.TRIGGER. The latch enable must be active for that purpose(see object 20A4 and 20A5).

Index	20A3h
Name	Latch position 2 negative edge CAP1.PLFB, Time capture CAP1.T
Object code	VAR
Data type	INTEGER32
Category	optional
Access	R/O
PDO mapping	possible
Value range	INTEGER32
Float scaling	var
Default value	0

5.4.37 Object 20A4h: Latch Control Register

The latch control register is used to enable the latch monitoring of the capture engines 0 and 1. The latch is enabled with a 1 signal and disabled with a 0 signal. Whether or not a latch event has occurred can be recognised by the latch status register (object 20A5).

Index	20A4h
Name	Latch Control Register
Object code	VAR
Data type	UNSIGNED16
Category	optional
Access	rww
PDO mapping	possible
Value range	0 to 15
Default value	0

Bit	Value (bin)	Value (hex)	Description
0	00000000 00000001	xx01	Enable extern latch 1 (positive rise)
1	00000000 00000010	xx02	Enable extern latch 1 (negative rise)
2	00000000 00000100	xx04	Enable extern latch 2 (positive rise)
3	00000000 00001000	xx08	Enable extern latch 2 (negative rise)
4	00000000 00010000	xx10	Enable latch of encoder index pulse
5 to 7			Reserve
8	00000001 00000000	01xx	Read external latch 1 (positive rise)
9	00000010 00000000	02xx	Read external latch 1 (negative rise)
10	00000011 00000000	03xx	Read external latch 2 (positive rise)
11	00000100 00000000	04xx	Read external latch 2 (negative rise)
12	00000101 00000000	05xx	Read latched position of encoder index pulse
13 to 15			Reserve

5.4.38 Object 20A5h: Latch Status Register

The latch status register is used to look for the states of the capture engines 0 and 1.

Index	20A5h
Name	Latch Status Register
Object code	VAR
Data type	UNSIGNED16
Category	optional
Access	rwr
PDO mapping	possible
Value range	-
Default value	0

Bit	Value (bin)	Value (hex)	Description
0	00000000 00000001	zz01	External latch 1 valid (positive rise)
1	00000000 00000010	zz02	External latch 1 valid (negative rise)
2	00000000 00000100	zz04	External latch 2 valid (positive rise)
3	00000000 00001000	zz08	External latch 2 valid (negative rise)
4	00000000 00010000	z10	Latched position of encoder index pulse valid (positive rise)
5 to 7			Reserve
8 to 11	00000001 00000000	z1zz	Acknowledge value external latch 1 (positive rise)
	00000010 00000000	z2zz	Acknowledge value external latch 1 (negative rise)
	00000011 00000000	z3zz	Acknowledge value external latch 2 (positive rise)
	00000100 00000000	z4zz	Acknowledge value external latch 2 (negative rise)
	00000101 00000000	z5zz	Acknowledge value of latched position of encoder index pulse (positive rise)
12 to 15	00010000 00000000	1zzz	State Digital Input 4
	00100000 00000000	2zzz	State Digital Input 3
	01000000 00000000	4zzz	State Digital Input 2
	10000000 00000000	8zzz	State Digital Input 1

5.4.39 Object 20A6h: Latch position 1, positive or negative edge

This object is used to output the position or a time, depending on CAP0.MODE, at which the first positive or negative edge occurred on a signal, that can be configured with CAP0.TRIGGER. Latch enable must be active for that purpose (see object 20A4 and 20A5).

Index	20A6h
Name	Latch position 1 positive or negative CAP0.PLFB
Object code	VAR
Data type	INTEGER32
Category	optional
Access	ro
PDO mapping	possible
Value range	INTEGER32
Float scaling	var
Default value	0

5.4.40 Object 20A7h: Latch position 2, positive or negative edge

This object is used to output the position or a time, depending on CAP1.MODE, at which the first positive or negative edge occurred on a signal, that can be configured with CAP1.TRIGGER. Latch enable must be active for that purpose (see object 20A4 and 20A5).

Index	20A7h
Name	Latch position 2 positive or negative CAP1.PLFB
Object code	VAR
Data type	INTEGER32
Category	optional
Access	ro
PDO mapping	possible
Value range	INTEGER32
Float scaling	var
Default value	0

5.4.41 Object 20B8h: Reset of changed input information

This object is used in PDOs to reset the state change information for the digital inputs shown in the Bits 24 to 30 in the object 60FD. Bit 0 to 6 are used to reset the information of the digital input 1 to 7.

Index	20B8h
Name	Reset of changed input information
Object code	VAR
Data type	UNSIGNED16
Category	optional
Access	rw
PDO mapping	possible
Value range	UNSIGNED16
Default value	0

5.4.42 Object 345Ah: Brake Control

These objects implement the possibility to control the brake directly, overriding the drive logic. When the brake state is controlled by the fieldbus, the drive state (enabled, disabled, faulted) will have no effect on the brake - the fieldbus will be in control.



CAUTION

Applying or releasing the brake at the wrong time can be a safety hazard and can destroy your mechanic as well as drive or motor. Unexpected behaviour might be possible. It is the responsibility of the customer using this mode to use this function appropriately.

When fieldbus control is disabled, the drive will control the brake as defined by existing AKD brake related parameters. As soon as fieldbus control is enabled, the Brake Command received over the field bus will take effect. So, if the Brake Command is set to APPLY and the current state is RELEASE, the brake will begin to apply .

The default value of the fieldbus control will be disabled, so that the drive is always in control until the fieldbus is operational. It is recommended that this bit remain 0 except for special operating conditions where the fieldbus will control the brake. When fieldbus communication is lost, the drive will regain control of the brake if the fieldbus had previously taken control.

Enable Field-bus Control	Serious Failure condition present	Brake Command	Fieldbus Control Status	Controlled by...	Final Brake State
0	x	x	0	Drive	Drive
1*	no	0	1	Fieldbus	Applied
1*	no	1	1	Fieldbus	Released
x	yes	any	0	Drive	Drive

1* indicates that a rising edge was seen since the last time the drive applied the brake

Index	345Ah
Name	Brake Control
Object code	ARRAY
Data type	UNSIGNED16
Category	optional

Defined sub-indices

Subindex	0
Name	number of entries
Data type	UNSIGNED8
Category	mandatory
Access	R/O
PDO Mapping	not possible
Value Range	2
Default Value	2

Subindex	1
Name	Brake Control Command
Category	optional
Access	R/W
PDO Mapping	possible
Value Range	UNSIGNED16
Default Value	0

With subindex 1 the brake is controlled. Bit definition:

Bit	Name	Description
0	Enable fieldbus control	0 - brake is not controlled via this object 1 - enable fieldbus control via this object. This function works edge triggered, i.e. this bit has to have a 0 -> 1 transition to activate the brake control functionality. After a fault the functionality is reset and has to be activated again. The activation can be controlled by subindex 2 bit 0.
1	Brake Command	This command bit is only active, if the functionality was activated via bit 0. The function is as follows: 0 - apply the brake 1 - release the brake

Subindex	2
Name	Brake Status Response
Category	optional
Access	R/O
PDO Mapping	possible
Value Range	UNSIGNED16
Default Value	0

With subindex 2 the brake status can be checked. Bit definition:

Bit	Name	Description
0	Fieldbus control Status	0 - brake control via 0x345A is disabled or not possible due to drive failure. 1 - enable fieldbus control via this object. This function works edge triggered, i.e. this bit has to have a 0 -> 1 transition to activate the brake control functionality. After a fault the functionality is reset and has to be activated again. The activation can be controlled by subindex 2 bit 0.
1	Brake Status	0 - apply the brake 1 - release the brake Note: When the brake is applied or released, there is a time delay MOTOR.TBRAKEAPP or MOTOR.TBRAKEREL, after the receipt of the command before this status bit changes. The status is always reported: it is not affected by fieldbus control.
2	STO Status	0 - STO is not active (drive may be enabled) 1 - STO is active (drive can not be enabled)
3	HW Enable Status	0 - HW enable is disabled, drive function can not be enabled 1 - HW enable is enabled, drive function can be enabled

5.4.43 Object 3474h: Parameters for digital inputs

This set of objects is used to set extended parameters for some digital input functions. The parameters can be used for different DINx.MODEs. Therefore the scaling might be different or no scaling is used at all.

Two subindices build an access object to one of these parameters, because they are 64-bit numbers internally, e.g. object 3474 sub 1 gives access to the low 32 bits of DIN1.PARAM whereas 3474 sub 4 gives access to the high 32 bits.

If access to the whole 64 bit number is needed the higher bits must be written first. The access to the lower 32 bits then writes the parameter. If the to be written value fits into 32 bit, only the lower part needs to be written. The most-significant bit is then taken as sign-bit for the number.

Index	3474h
Name	DINx.PARAM
Object code	Array
Data type	UNSIGNED32
Category	optional
Subindex	0
Description	number of entries
Category	mandatory
Access	R/O
PDO mapping	not possible
Value range	0xE
Default value	0xE
Subindex	1 to 3
Description	DINx.PARAM low 32 bits, x = 1 .. 3
Category	optional
Access	R/W
PDO mapping	not possible
Value range	UNSIGNED32
Default value	0
Subindex	4 to 6
Description	DINx.PARAM high 32 bits, x = 1 .. 3
Category	optional
Access	R/W
PDO mapping	not possible
Value range	UNSIGNED32
Default value	0

5.4.44 Object 3475h: Parameters for digital outputs

This set of objects is used to set extended parameters for some digital output functions. The parameters can be used for different DOUTx.MODEs. Therefore the scaling might be different or no scaling is used at all.

Two subindices build an access object to one of these parameters, because they are 64-bit numbers internally, e.g. object 3475 sub 1 gives access to the low 32 bits of DOUT1.PARAM whereas 3475 sub 2 gives access to the high 32 bits.

If access to the whole 64 bit number is needed the higher bits must be written first. The access to the lower 32 bits then writes the parameter. If the to be written value fits into 32 bit, only the lower part needs to be written. The most-significant bit is then taken as sign-bit for the number.

Index	3475h
Name	DOUTx.PARAM
Object code	Array
Data type	UNSIGNED32
Category	optional
Subindex	0
Description	number of entries
Category	mandatory
Access	R/O
PDO mapping	not possible
Value range	0x4
Default value	0x4
Subindex	1
Description	DOUTx.PARAM low 32 bits, x = 1
Category	optional
Access	R/W
PDO mapping	not possible
Value range	UNSIGNED32
Default value	0
Subindex	2
Description	DOUTx.PARAM high 32 bits, x = 1
Category	optional
Access	R/W
PDO mapping	not possible
Value range	UNSIGNED32
Default value	0

5.4.45 Object 3496h: Fieldbus synchronization parameters

This set of objects is used to set or read parameters for the fieldbus synchronization used in the interpolated position mode (7) and the cyclic-modes 8 etc. The synchronization between a fieldbus master and the AKD is similar in all the supported fieldbus systems.

The AKD internal 16[kHz] interrupt function is responsible for calling the PLL function. This PLL function is called once per fieldbus cycle (set by object 60C2 sub 1 and 2). If the fieldbus sample period is for example 1[ms], the PLL code is called every 16th time of the 16[kHz] IRQ of the AKD.

Once in a fieldbus sample the SYNC-telegram must arrive, which resets a PLL counter in the Drive. After some time the already mentioned PLL function is called and reads back the time from that PLL counter.

Depending on the measured time the PLL function extends (in case that the measured time is too low) or lowers (in case that the measured time is too high) the sample time of the upcoming 16[kHz] tasks for one fieldbus sample by a selectable value (object 3496 sub 4) in order to move the PLL function closer to the expected distance (object 3496 sub 1).

Beside the objects mentioned here the parameter FBUS.SAMPLEPERIOD is important, which is set by object 60C2 sub 1 and 2. This setting is required in order to share the fieldbus sample time with the slave. This information is e.g. needed for being able to call the AKD internal PLL function once per fieldbus sample.

Index	3496h
Name	FBUS synchronization parameters
Object code	Array
Data type	UNSIGNED32
Category	optional
Subindex	0
Description	number of entries
Category	mandatory
Access	R/O
PDO mapping	not possible
Value range	0x4
Default value	0x4
Subindex	1
Description	FBUS.SYNCDIST
Category	optional
Access	R/W
PDO mapping	not possible
Value range	UNSIGNED32
Default value	320000 [ns]

Sub 1 is the expected time distance in nano seconds between clearing the PLL counter and calling the PLL function.

Subindex	2
Description	FBUS.SYNCACT
Category	optional
Access	R/W
PDO mapping	not possible
Value range	UNSIGNED32
Default value	320000 [ns]

Sub 2 is the actual time distance in nano seconds between clearing the PLL counter and calling the PLL function.

Subindex	3
Description	FBUS.SYNCWND
Category	optional
Access	R/W
PDO mapping	not possible
Value range	UNSIGNED32
Default value	70000 [ns]

Sub 3 is a window, which is used in order to consider the drive as being synchronized. The AKD is considered as synchronized in the following case:

$$FBUS.SYNCDIST - FBUS.SYNCWND < FBUS.SYNCACT < FBUS.SYNCDIST + FBUS.SYNCWND$$

Subindex	4
Description	FBUS.COMPTIME
Category	optional
Access	R/W
PDO mapping	not possible
Value range	UNSIGNED32
Default value	150 [ns]

Sub 4 value indicates the time, which is used for extending or lowering the sample rate of the AKD internal 16[kHz] IRQ, which is responsible for calling the PLL function. The default sample time is $32 * 1/16[\text{kHz}] = 2[\text{ms}]$.

The sample time of the AKD high prior interrupt is determined by $62.5[\mu\text{s}] - FBUS.COMPTIME$ if $FBUS.SYNCACT > FBUS.SYNCDIST$.

The sample time of the AKD high prior interrupt is determined by $62.5[\mu\text{s}] + FBUS.COMPTIME$ if $FBUS.SYNCACT < FBUS.SYNCDIST$.

5.4.46 Object 6040h: Control word (DS402)

The control commands are built up from the logical combination of the bits in the control word and external signals (e.g enable output stage). The definitions of the bits are shown below:

Index	6040h
Name	control word
Object code	VAR
Data type	UNSIGNED16
Access	R/W
PDO mapping	possible
Unit	—
Value range	0 to 65535
EEPROM	no
Default value	0

Bit assignment im control word

Bit	Name	Bit	Name
0	Switch on	8	Pause/halt
1	Disable Voltage	9	reserved
2	Quick Stop	10	reserved
3	Enable Operation	11	reserved
4	Operation mode specific	12	reserved
5	Operation mode specific	13	Manufacturer-specific
6	Operation mode specific	14	Manufacturer-specific
7	Reset Fault (only effective for faults)	15	Manufacturer-specific

Commands in the control word

Command	Bit 7 Fault Reset	Bit 3 Enable Operation	Bit 2 Quick Stop	Bit 1 Disable Voltage	Bit 0 Switch on	Transitions
Shutdown	X	X	1	1	0	2, 6, 8
Switch on	X	X	1	1	1	3
Disable Voltage	X	X	X	0	X	7, 9, 10, 12
Quick Stop	X	X	0	1	X	7, 10, 11
Disable Operation	X	0	1	1	1	5
Enable Operation	X	1	1	1	1	4, 16
Fault Reset	1	X	X	X	X	15

Bits marked by an X are irrelevant.

Mode-dependent bits in the control word

The following table shows the mode-dependent bits in the control word. Only manufacturer-specific modes are supported at present. The individual modes are set by Object 6060_n Modes of operation.

Operation mode	No.	Bit 4	Bit 5	Bit 6
Profile Position Mode (pp)	01h	new_setpoint	change_set_immediately	absolute/relative
Profile Velocity Mode (pv)	03h	reserved	reserved	reserved
Profile Torque Mode (tq)	04h	reserved	reserved	reserved
Homing Mode (hm)	06h	homing_operation_start	reserved	reserved
Interpolated Position Mode (ip)	07h	Enable Interpolation	reserved	reserved
Cyclic sync position Mode (csp)	08h	reserved	reserved	reserved

Description of the remaining bits in the control word

The remaining bits in the control word are described below.

Bit 8 Pause If Bit 8 is set, then the drive halts (pauses) in all modes. The setpoints (speed for homing or jogging, motion task number, setpoints for digital mode) for the individual modes are retained.

Bit 9,10 These bits are reserved for the drive profile (DS402).

Bit 13, 14, 15 These bits are manufacturer-specific, and reserved at present.

5.4.47 Object 6041h: Status word (DS402)

The momentary state of the status machine can be read out with the aid of the status word.

Index	6041h
Name	Status word
Object code	VAR
Data type	UNSIGNED16
Access	R/W
PDO mapping	possible
Unit	—
Value range	0 to 65535
EEPROM	yes
Default value	0

Bit assignment in the status word

Bit	Name	Bit	Name
0	Ready to switch on	8	Manufacturer-specific (reserved)
1	Switched on	9	Remote
2	Operation enabled	10	Target reached
3	Fault	11	Internal limit active
4	Voltage enabled	12	Operation mode specific (reserved)
5	Quick stop	13	Operation mode specific (reserved)
6	Switch on disabled	14	Manufacturer-specific (reserved)
7	Warning	15	Manufacturer-specific (reserved)

States of the status machine

State	Bit 6 switch on disabled	Bit 5 quick stop	Bit 3 fault	Bit 2 operation enabled	Bit 1 switched on	Bit 0 ready to switch on
Not ready to switch on	0	X	0	0	0	0
Switch on disabled	1	X	0	0	0	0
Ready to switch on	0	1	0	0	0	1
Switched on	0	1	0	0	1	1
Operation enabled	0	1	0	1	1	1
Fault	0	X	1	0	0	0
Fault reaction active	0	X	1	1	1	1
Quick stop active	0	0	0	1	1	1

Bits marked by X are irrelevant

Description of the remaining bits in the status word

Bit 4: `voltage_enabled` The DC-link voltage is present if this bit is set.

Bit 7: `warning` There are several possible reasons for Bit 7 being set and this warning being produced. The reason of a warning can be seen by the Error code of the Emergency message, which is sent on the bus caused by this warning.

Bit 9: The remote-bit is set by the telnet command `FBUS.REMOTE`. The default state is 1 indicating that the power stage shall be only controlled by the DS402 control word. For special actions via telnet like tuning or commutation finding, `FBUS.REMOTE` shall be set to 0 via telnet to inform the fieldbus master.

Bit 10: `target_reached` This is set when the drive has reached the target position.

Bit 11: `internal_limit_active` This bit specifies that a movement was or is limited. In different modes, different warnings cause the bit to be set. The following assignments exist:

Mode of operation	Warnings which set Bit 11
all	n04, n06, n07, n10, n11, n14
0x1 (PP), 0x88	n03, n08, n09, n20

5.4.48 Object 6060h: Modes of Operation (DS402)

This object is used to set the mode, which can be read out by Object 6061h. Two types of operating mode are used:

- manufacturer-specific operating modes
- operating modes as per CANopen drive profile DS402

These operating modes are defined in the CANopen drive profile DS402. After the mode has been changed, the corresponding setpoint must be set once more (for instance, the homing velocity in the mode homing_setpoint). If the position or jogging mode is stored, then the Homing mode is set after a RESET of the drive.

NOTE

An operating mode only becomes valid when it can be read by Object 6061h.



WARNING

Never change the mode while the motor is running! The drive could move unexpectedly. When the drive is enabled, a mode change is only permissible at zero speed. Set the speed setpoint to 0 before changing over.

Index	6060h
Name	mode of operation
Object code	VAR
Data type	INTEGER8
Category	mandatory
Access	R/W
PDO mapping	possible
Value range	1, 3, 4, 6, 7, 8
Default value	—

Supported modes (negative values are manufacturer specific modes):

Value (hex)	Mode
1	Profile position mode
3	Profile velocity mode
4	Profile torque mode
6	Homing mode
7	Interpolated position mode
8	Cyclic synchronous position mode

5.4.49 Object 6061h: Modes of Operation Display (DS402)

This object can be used to read the mode that is set by Object 6060h. An operating mode only becomes valid when it can be read by Object 6061h (see also Object 6060h).

Index	6061h
Name	mode of operation display
Object code	VAR
Data type	INTEGER8
Category	mandatory
Access	R/O
PDO mapping	possible
Value range	1, 3, 4, 6, 7, 8
Default value	—

5.4.50 Object 6063h: position actual value* (DS402)

The object position actual value provides the momentary actual position in increments. The resolution is defined with Object 608F as power-of-two number.

Index	6063h
Name	position actual value
Object code	VAR
Data type	INTEGER32
Mode	pc, pp
Access	R/W
PDO mapping	possible
Unit	increments (1 turn = 2^{PRBASE})
Value range	(-2^{31}) to $(2^{31}-1)$
Default value	2^{20}
EEPROM	no

5.4.51 Object 6064h: position actual value (DS402)

The object position actual value provides the actual position. The resolution can be altered by the gearing factors of the position controller (Object 6091/6092).

Index	6064h
Name	position actual value, PL.FB
Object code	VAR
Data type	INTEGER32
Mode	pp, csp
Access	R/W
PDO mapping	possible
Unit	position units
Value range	(-2^{31}) to $(2^{31}-1)$
Default value	—
EEPROM	no

5.4.52 Object 6065h: Following error window

The following error window defines a range of tolerated position values symmetrically to the position demand value. A following error might occur when a drive is blocked, unreachable profile velocity occurs, or at wrong closed loop coefficients. If the value of the following error window is 0, the following control is switched off.

Index	6065h
Name	Following error window
Object code	VAR
Data type	UNSIGNED32
Category	optional
Access	R/W
PDO mapping	not possible
Value range	UNSIGNED32
Default value	0

5.4.53 Object 606Ch: Velocity actual value (DS402)

The object velocity actual value represents the actual speed.

Index	606Ch
Name	velocity actual value, VL.FB
Object code	VAR
Data type	INTEGER32
Mode	pv
Access	R/O
PDO mapping	possible
Unit	velocity units (SDO is in user units and the PDO is in RPM)
Value range	(-2^{31}) to $(2^{31}-1)$
Default value	—
Float scaling	1000:1
EEPROM	no

5.4.54 Object 6071h: Target torque (DS402)

This parameter is the input value for the torque controller in profile torque mode and the value is given per thousand (1‰) of rated torque.

Index	6071h
Name	Target torque
Object code	VAR
Data type	INTEGER16
Category	conditional; mandatory, if tq supported
Access	R/W
PDO mapping	possible
Value range	INTEGER16
Default value	0

5.4.55 Object 6073h: Max current (DS402)

This value represents the maximum permissible torque creating current in the motor and is given per thousand (1‰) of rated current.

Index	6073h
Name	Max current
Object code	VAR
Data type	UNSIGNED16
Category	optional
Access	R/W
PDO mapping	not possible
Value range	UNSIGNED16
Default value	0

5.4.56 Object 6077h: Torque actual value (DS402)

The torque actual value corresponds to the instantaneous torque in the drive motor. The value is given per thousand (1‰) of rated torque.

Index	6077h
Name	Torque actual value
Object code	VAR
Data type	INTEGER16
Category	optional
Access	R/O
PDO mapping	possible
Value range	INTEGER16
Default value	0

5.4.57 Object 607Ah: Target position (DS402)

The object target position defines the target position for the drive. The target position is interpreted as a relative distance or an absolute position, depending on Bit 6 of the control word. The type of relative movement can be further defined by the manufacturer-specific parameter 35B9h Subindex 0. Other properties like following motion tasks can be set with this object as well. The mechanical resolution is set via the scaling objects 6091h and 6092h.

Index	607Ah
Name	target position, MT.P
Object code	VAR
Data type	INTEGER32
Mode	pp, csp
Access	R/W
PDO mapping	possible
Unit	user-defined
Value range	$-(2^{31}-1)$ to $(2^{31}-1)$
Default value	—

5.4.58 Object 607Ch: Homing offset (DS402)

The reference offset (home offset) is the difference between the zero position for the application and the zero point of the machine. All subsequent absolute motion tasks take account of the reference offset.

Index	607Ch
Name	home offset, HOME.P
Object code	VAR
Data type	INTEGER32
Mode	hm
Access	R/W
PDO mapping	not possible
Unit	user-defined
Value range	(-2^{31}) to $(2^{31}-1)$
Default value	0

5.4.59 Object 607Dh: Software position limit (DS402)

Software position limit contains the sub-parameters min position limit and max position limit. New target positions are checked against these limits. The limits are relative to the machine home position, which is the result of homing (including the home offset (Object 607Ch)). As default the software position limits are switched off. Changed values must be saved and the drive must be restarted to take enable the new the software limits.

Index	607Dh
Name	Software position limit, SWLS.LIMIT0
Object code	ARRAY
Data type	INTEGER32
Category	optional
Subindex	0
Description	number of entries
Category	mandatory
Access	R/O
PDO mapping	not possible
Value range	2
Default value	2
Subindex	1
Description	min position limit 1, SWLS.LIMIT0
Category	mandatory
Access	R/W
PDO mapping	not possible
Value range	INTEGER32
Default value	0 (switched off)
Subindex	2
Description	Min Position Limit 2, SWLS.LIMIT1
Category	mandatory
Access	R/W
PDO mapping	not possible
Value range	INTEGER32
Default value	0 (switched off)

5.4.60 Object 6081h: Profile velocity (DS402)

The profile velocity is the final velocity that should be reached after the acceleration phase of a motion task.

Index	6081h
Name	profile velocity, MT.V
Object code	VAR
Data type	UNSIGNED32
Mode	pp
Access	R/W
PDO mapping	possible
Unit	speed units
Value range	0 to $(2^{32}-1)$
Default value	10

5.4.61 Object 6083h: Profile acceleration (DS402)

The acceleration ramp (profile acceleration) is given in units that are defined by the user (position units per s^2). The position units are scaled via the objects 6091 and 6092. This object is connected to the AKD-parameter DRV.ACC in the Profile Velocity Mode and to the motion task parameter MT.ACC in all other modes.

Index	6083h
Name	profile acceleration, MT.ACC (DRV.ACC in Profile Velocity Mode)
Object code	VAR
Data type	UNSIGNED32
Mode	pp, pv
Access	R/W
PDO mapping	possible
Unit	acceleration units
Value range	0 to $(2^{32}-1)$
Default value	0

5.4.62 Object 6084h: Profile deceleration (DS402)

The braking/deceleration ramp is handled in the same way as the acceleration ramp (" Object 6083h: Profile acceleration (DS402)" (→ p. 125)).

Index	6084h
Name	profile deceleration, MT.DEC (DRV.DEC in Profile Velocity Mode)
Object code	VAR
Data type	UNSIGNED32
Mode	pp, pv
Access	R/W
PDO mapping	possible
Unit	deceleration units
Value range	0 to $(2^{32}-1)$
Default value	0

5.4.63 Object 608Fh: Position encoder resolution (DS402)

The position encoder resolution defines the ratio of encoder increments per motor revolution on the CANopen end. Encoder increments are set either directly by subindex 1 (only powers of 2 available) or implicit by writing to the parameter FB1.PSCALE.

Index	608Fh
Name	Position encoder resolution
Object Code	ARRAY
Data Type	UNSIGNED 32
Category	optional
Subindex	0
Name	number of entries
Data type	UNSIGNED8
Category	mandatory
Access	R/O
PDO Mapping	not possible
Value Range	2
Default Value	2
Subindex	1
Name	Encoder increments
Category	mandatory
Access	R/W
PDO Mapping	not possible
Value Range	UNSIGNED 32
Default Value	2 ²⁰
Subindex	2
Name	Motor revolutions
Category	mandatory
Access	R/W
PDO Mapping	not possible
Value Range	UNSIGNED 32
Default Value	1

5.4.64 Object 6091h: Gear Ratio (DS402)

The gear ratio defines the ratio of feed in position units per driving shaft revolutions. This includes the gear if present.

gear ratio = motor shaft revolutions / driving shaft revolutions

Index	6091h
Name	Gear Ratio
Object Code	ARRAY
Data Type	UNSIGNED 32
Category	optional
Subindex	0
Name	number of entries
Data type	UNSIGNED8
Category	mandatory
Access	R/O
PDO Mapping	not possible
Value Range	2
Default Value	2
Subindex	1
Name	Motor revolution
Category	mandatory
Access	R/W
PDO Mapping	not possible
Value Range	UNSIGNED 32
Default Value	1
Subindex	2
Name	Shaft revolutions
Category	mandatory
Access	R/W
PDO Mapping	not possible
Value Range	UNSIGNED 32
Default Value	1

5.4.65 Object 6092h: Feed constant (DS402)

The feed constant defines the ratio of feed in position units per driving shaft revolutions. This includes the gear if present.

Index	6092h
Name	Feed constant
Object Code	ARRAY
Data Type	UNSIGNED 32
Category	optional
Subindex	0
Name	number of entries
Data type	UNSIGNED8
Category	mandatory
Access	R/O
PDO Mapping	not possible
Value Range	2
Default Value	2
Subindex	1
Name	Feed
Category	mandatory
Access	R/W
PDO Mapping	not possible
Value Range	UNSIGNED 32
Default Value	1
Subindex	2
Name	Shaft revolutions
Category	mandatory
Access	R/W
PDO Mapping	not possible
Value Range	UNSIGNED 32
Default Value	1

5.4.66 Object 6098h: Homing method (DS402)

Index	6098h
Name	homing method, HOME.MODE, HOME.DIR
Object code	VAR
Data type	INTEGER8
Mode	hm
Access	R/W
PDO mapping	not possible
Unit	position units
Value range	-128 to 127
Default value	0

Description of the homing methods

Choosing a homing method by writing a value to homing method (Object 6098h) will clearly establish:

- the homing signal (P-Stop, N-Stop, reference switch)
- the direction of actuation

and where appropriate

- the position of the index pulse.

The reference position is give by the reference offset (Object 607Ch).

A detailed description of the types of homing movement can be found in the description of WorkBench.

The following homing methods are supported:

Method as per DS402	Brief description: Homing	command
-128 to -1	reserved	—
0	reserved	—
1	homing to negative limit switch, with zeroing, negative count direction	HOME.MODE=2, HOME.DIR=0
2	homing to positive limit switch, with zeroing, positive count direction	HOME.MODE=2, HOME.DIR=1
3 to 7	not supported	—
8	homing to reference switch, with zeroing, positive count direction	HOME.MODE=5, HOME.DIR=1
9 to 11	not supported	—
12	homing to reference switch, with zeroing, negative count direction	HOME.MODE=5, HOME.DIR=0
13 to 14	not supported	—
15 to 16	reserved	—
17	homing to negative limit switch, without zeroing, negative count direction	HOME.MODE=1, HOME.DIR=0
18	homing to negative limit switch, without zeroing, positive count direction	HOME.MODE=1, HOME.DIR=1
19 to 23	not supported	—
24	homing to reference switch, without zeroing, positive count direction	HOME.MODE=4, HOME.DIR=1
25 to 27	not supported	—

Method as per DS402	Brief description: Homing	command
28	homing to reference switch, without zeroing, negative count direction	HOME.MODE=4, HOME.DIR=0
29 to 30	not supported	—
31 to 32	reserved	—
33	homing within a single turn, negative count direction. If the feedback has an index pulse, HOME.MODE 11 will be used.	HOME.MODE=7,11 HOME.DIR=0
34	homing within a single turn, positive count direction. If the feedback has an index pulse, HOME.MODE 11 will be used.	HOME.MODE=7,11 HOME.DIR=1
35	set reference point at present position	HOME.MODE=0, HOME.DIR=0
36 to 127	reserved	—

5.4.67 Object 6099h: Homing speeds (DS402)

Index	6099h
Name	homing speeds
Object code	ARRAY
Data type	UNSIGNED32
Subindex	1
Description	speed during search for switch, HOME.V
Mode	hm
Access	R/W
PDO mapping	not possible
Unit	velocity units
Value range	0 to $(2^{32}-1)$
Default value	equivalent 60 rpm
Subindex	2
Description	speed during search for zero, HOME.FEEDRATE
Mode	hm
Access	R/W
PDO mapping	not possible
Unit	velocity units
Value range	0 to $(2^{32}-1)$
Default value	1/8 * Object 6099 sub 1

5.4.68 Object 609Ah: Homing acceleration (DS402)

Index	609Ah
Name	homing acceleration
Object code	VAR
Data type	UNSIGNED32
Mode	hm
Access	R/W
PDO mapping	not possible
Unit	acceleration units
Value range	0 to $(2^{32}-1)$
Default value	0

5.4.69 Object 60B1h: Velocity Offset

This object provides the offset of the velocity value in cyclic synchronous position mode. It is scaled via the object 204Ch.

Index	60B1h
Name	Velocity Offset
Object code	VAR
Data type	INTEGER32
Category	optional
Access	R/W
PDO mapping	possible
Value range	INTEGER32
Default value	0

5.4.70 Object 60B2h: Torque Offset

This object provides the offset of the commanded torque value in cyclic synchronous position mode. Scaling is 1/1000 of rated torque.

Index	60B2h
Name	Torque Offset
Object code	VAR
Data type	INTEGER16
Category	optional
Access	R/O
PDO mapping	possible
Value range	INTEGER16
Default value	0

5.4.71 Object 60B8h: Touch probe function

This object indicates the configured function of the touch probe.

Index	60B8h
Name	Touch probe function
Object code	Variable
Data type	UNSIGNED16
Category	optional
Access	R/W
PDO Mapping	yes
Value range	UNSIGNED16
Default value	0

Definition of the possible functions:

Bit	Value	Meaning
0	0	Switch off touch probe 1
	1	Enable touch probe 1
1	0	Trigger first event
	1	Continuous
3, 2	00b*	Trigger with touch probe 1 input
	01b	Trigger with zero impulse signal or position encoder
	10b	Touch probe source as defined in object 60D0h, sub-index 01h
	11b	reserved
4	0	Switch off sampling at positive edge of touch probe 1
	1	Enable sampling at positive edge of touch probe 1
5	0	Switch off sampling at negative edge of touch probe 1
	1	Enable sampling at negative edge of touch probe 1
6, 7	-	User-defined (e.g. for testing)
8	0	Switch off touch probe 2
	1	Enable touch probe 2
9	0	Trigger first event
	1	continuous
11, 10	00b	Trigger with touch probe 2 input
	01b	Trigger with zero impulse signal or position encoder
	10b	Touch probe source as defined in object 60D0h, sub-index 02h
	11b	reserved
12	0	Switch off sampling at positive edge of touch probe 2
	1	Enable sampling at positive edge of touch probe 2
13	0	Switch off sampling at negative edge of touch probe 2
	1	Enable sampling at negative edge of touch probe 2
14, 15	-	User-defined (e.g. for testing)

* b = binary

If both edges are selected at the same time (bit 4=1 and bit 5=1 for probe 1 or bit 12=1 and bit 13=1 for probe 2), the first edge (positive or negative) triggers the probe function. The position, latched at this edge, is taken over for both edges (positive and negative).

5.4.72 Object 60B9h: Touch probe status

This object indicates the status of the touch probe.

Index	60B9h
Name	Touch probe status
Object code	Variable
Data type	UNSIGNED16
Category	optional
Access	R/O
PDO Mapping	yes
Value range	UNSIGNED16
Default value	0

Definition of the status:

Bit	Value	Meaning
0	0	Touch probe 1 is switched off
	1	Touch probe 1 is enabled
1	0	Touch probe 1 no positive edge value stored
	1	Touch probe 1 positive edge position stored
2	0	Touch probe 1 no negative edge value stored
	1	Touch probe 1 negative edge position stored
3 to 5	0	reserved
6, 7	-	User-defined (e.g. for testing)
8	0	Touch probe 2 is switched off
	1	Touch probe 2 is enabled
9	0	Touch probe 2 no positive edge value stored
	1	Touch probe 2 positive edge position stored
10	0	Touch probe 2 no negative edge value stored
	1	Touch probe2 negative edge position stored
11 to 13	0	reserved
14, 15	-	User-defined (e.g. for testing)

5.4.73 Object 60BAh: Touch probe 1 positive edge

This object provides the position value of the touch probe 1 at positive edge.

Index	60BAh
Name	Touch probe 1 positive edge
Object code	Variable
Data type	INTEGER32
Category	optional
Access	R/O
PDO Mapping	yes
Value range	INTEGER32
Default value	no

5.4.74 Object 60BBh: Touch probe 1 negative edge

This object provides the position value of the touch probe 1 at negative edge.

Index	60BBh
Name	Touch probe 1 negative edge
Object code	Variable
Data type	INTEGER32
Category	optional
Access	R/O
PDO Mapping	yes
Value range	INTEGER32
Default value	no

5.4.75 Object 60BCh: Touch probe 2 positive edge

This object provides the position value of the touch probe 2 at positive edge.

Index	60BCh
Name	Touch probe 2 positive edge
Object code	Variable
Data type	INTEGER32
Category	optional
Access	R/O
PDO Mapping	yes
Value range	INTEGER32
Default value	no

5.4.76 Object 60BDh: Touch probe 2 negative edge

This object provides the position value of the touch probe 2 at negative edge.

Index	60BDh
Name	Touch probe 2 negative edge
Object code	Variable
Data type	INTEGER32
Category	optional
Access	R/O
PDO Mapping	yes
Value range	INTEGER32
Default value	no

5.4.77 Object 60C0h: Interpolation sub mode select

In the AKD, both linear interpolation between position setpoints and Cubic polynomial interpolation between position/velocity/time setpoints are supported.

In the AKD, linear interpolation between position setpoints is supported.

Index	60C0h
Name	Interpolation sub mode select
Object code	VAR
Data type	INTEGER16
Category	optional
Access	R/W
PDO mapping	not possible
Value range	-2, -1, 0
Default value	0

Value description

Value(decimal)	Description
0	Linear interpolation with a constant time.
-1	Reserved.
-2	Cubic polynomial interpolation, which is also known as position, velocity, and time (PVT) interpolation.

5.4.78 Object 60C1h: Interpolation data record

In the AKD, a single setpoint (target position, Subindex 1) is supported for the linear interpolation. For cubic polynomial interpolation 3 setpoints is supported, target position, time and velocity (Subindex1 to Subindex3). After the last item of an interpolation data record is written to the devices input buffer, the pointer of the buffer is automatically incremented to the next buffer.

Index	60C1h
Name	Interpolation data record
Object code	ARRAY
Data type	INTEGER32
Category	optional
Subindex	0
Description	number of entries
Data type	UNSIGNED8
Category	mandatory
Access	R/O
PDO mapping	not possible
Value range	13
Default value	13
Subindex	1
Description	Interpolation target position in counts, the first parameter of interpolation function
Category	mandatory
Access	R/W
PDO mapping	possible
Value range	INTEGER32
Default value	no
Subindex	2
Description	Interpolation time in ms, the second parameter of interpolation function. It means the interval time until move to target PVT Point n+1. Set to zero to end the move.
Category	mandatory
Access	R/W
PDO mapping	possible
Value range	UNSIGNED32
Default value	no
Subindex	3
Description	Interpolation target velocity in counts/s, the third parameter of interpolation function.
Category	mandatory
Access	R/W
PDO mapping	possible
Value range	INTEGER32
Default value	no

5.4.79 Object 60C2h: Interpolation time period

The interpolation time period is used for the PLL (phase locked loop) synchronized position modes. The unit (subindex 1) of the time is given in $10^{\text{interpolation time index}}$ seconds. Only multiples of 1 ms are allowed. The two values define the internal ASCII - parameter PTBASE (given in multiples of 250 Mikroseconds). Both values must be written to fix a new interpolation time period. PTBASE will only be updated then.

Index	60C2h
Name	Interpolation time period
Object code	RECORD
Data type	Interpolation time period record (0080h)
Category	optional
Subindex	0
Description	number of entries, FBUS.SAMPLEPERIOD
Category	mandatory
Access	R/O
PDO mapping	not possible
Value range	2
Default value	2
Subindex	1
Description	Interpolation time units
Category	mandatory
Access	R/W
PDO mapping	not possible
Value range	UNSIGNED8
Default value	1
Subindex	2
Description	Interpolation time index
Category	mandatory
Access	R/W
PDO mapping	not possible
Value range	INTEGER16
Default value	1

5.4.80 Object 60C4h: Interpolation data configuration

In the AKD, for linear interpolation, only the value 1 in Subindex 5 is possible. For cubic interpolation, Subindex 1 and Subindex 2 is possible for manage the buffer of cubic interpolation.

Index	60C4h
Name	Interpolation data configuration
Object code	RECORD
Data type	Interpolation data configuration record (0081h)
Category	optional
Subindex	0
Description	number of entries
Category	mandatory
Access	R/O
PDO mapping	not possible
Value range	6
Default value	6
Subindex	1
Description	Maximum buffer size
Category	mandatory
Access	R/O
PDO mapping	not possible
Value range	UNSIGNED32
Default value	10
Subindex	2
Description	Actual buffer size
Category	mandatory
Access	R/O
PDO mapping	possible
Value range	0 to 9
Default value	9
Subindex	3
Description	Buffer organization
Category	mandatory
Access	R/W
PDO mapping	not possible
Value range	UNSIGNED8
Default value	0

Subindex	4
Description	Buffer position
Category	mandatory
Access	R/W
PDO mapping	not possible
Value range	UNSIGNED16
Default value	0
Subindex	5
Description	Size of data record
Category	mandatory
Access	W
PDO mapping	not possible
Value range	1 to 254
Default value	1
Subindex	6
Description	Buffer clear
Category	mandatory
Access	W
PDO mapping	not possible
Value range	UNSIGNED8
Default value	0

5.4.81 Object 60D0h: Touch probe source

This object provides the source of the touch probe function, when the dedicated bits 2/3 or 10/11 of the touch probe function (object 60B8h) are set accordingly.

Index	60D0h
Name	Touch probe source
Object code	Array
Data type	Integer 16
Category	optional
Subindex	0
Description	Highest sub-index supported
Category	mandatory
Access	R/O
PDO mapping	not possible
Value range	2
Default value	2
Subindex	1
Description	Touch probe 1 source
Category	mandatory
Access	R/W
PDO mapping	not possible
Value range	-11 to -1, 1 to 5
Default value	1
Subindex	2
Description	Touch probe 2 source
Category	mandatory
Access	R/W
PDO mapping	not possible
Value range	-11 to -1, 1 to 5
Default value	1

5.4.82 Object 60F4h: Following error actual value (DS402)

This object returns the current value of the following error in units defined by the user.

Index	60F4h
Name	Following error actual value
Object code	VAR
Data type	Integer32
Category	optional
Access	R/O
PDO mapping	possible
Value range	INTEGER32
Default value	0

5.4.83 Object 60FDh: Digital inputs (DS402)

This index defines simple digital inputs for drives. The manufacturer bits 16 to 18 are used to mirror the digital inputs 1 to 3. The manufacturer bits 24 to 26 are used to show the change of the state of the digital inputs 1 to 3.

Index	60FDh
Name	digital inputs
Object code	VAR
Data type	UNSIGNED32
Category	optional
Access	R/O
PDO mapping	possible
Value range	UNSIGNED32
Default value	0

31	16	15	4	3	2	1	0
manufacturer specific		reserved		interlock	home switch	pos. limit switch	neg. limit switch
MSB							LSB

5.4.84 Object 60FEh: Digital outputs (DS402)

This index defines simple digital outputs for drives. The manufacturer bit 16 is used to mirror the digital output 1.

Index	60FEh					
Name	digital outputs					
Object code	Array					
Data type	UNSIGNED32					
Category	optional					
Subindex	0					
Description	number of entries					
Category	mandatory					
Access	R/O					
PDO mapping	not possible					
Value range	2					
Default value	2					
Subindex	1					
Description	physical outputs					
Category	mandatory					
Access	R/W					
PDO mapping	possible					
Value range	UNSIGNED32					
Default value	0					
Subindex	2					
Description	bit mask					
Category	optional					
Access	R/W					
PDO mapping	not possible					
Value range	UNSIGNED32					
Default value	0					
31	18	17	16	15	1	0
manufacturer specific		DOUT2	DOUT1	reserved		set brake
MSB						LSB

5.4.85 Object 60FFh: Target velocity (DS402)

The speed setpoint (target velocity) represents the setpoint for the ramp generator.

Index	60FFh
Name	target velocity, VL.CMDU
Object code	VAR
Data type	INTEGER32
Mode	pv
Access	R/W
PDO mapping	possible
Unit	increments
Value range	(-2^{31}) to $(2^{31}-1)$
Default value	—
Float scaling	1000:1
EEPROM	no

5.4.86 Object 6502h: Supported drive modes (DS402)

A drive can support more than one and several distinct modes of operation. This object gives an overview of the implemented operating modes in the device. This object is read only.

Index	6502h
Name	supported drive modes
Object code	VAR
Data type	UNSIGNED32
Category	optional
Access	R/O
PDO mapping	not possible
Value range	UNSIGNED32
Default value	0xE5 (csp ip hm pv pp)

31	16	15	11	10	9	8	7	6	5	4	3	2	1	0
manufacturer specific	reserved	cstca	cst	csv	csp	ip	hm	reserved	tq	pv	vl	pp		
MSB														LSB

6 Record of Document Revisions

Revision	Remarks
A, 05/2014	First edition

7 Index

1

1000h	80
1001h	81
1002h	82
1003h	83
1005h	84
1006h	84
1008h	85
1009h	85
100Ah	85
100Ch	86
100Dh	86
1010h	87
1011h	88
1012h	89
1014h	89
1016h	90
1017h	91
1018h	91
1026h	93
1400-1403h	94
1600-1603h	95
1800-1803h	96
1A00-1A03h	98

2

2000h	99
2001h	99
2002h	100
2014-2017h	101
2018h	102
2026h	103
204Ch	104
2071h	105
2077h	105
20A0h	105
20A1h	106
20A2h	106
20A3h	107
20A4h	107
20A5h	108
20A6h	108
20A7h	109
20B8h	109

3

345Ah	110
3474h	112
3475h	113
3496h	114

6

6040h	116
6041h	117
6060h	119
6061h	120
6063h	120
6064h	120
6065h	121
606Ch	121
6071h	122
6073h	122
6077h	122
607Ah	123
607Ch	123
607Dh	124
6081h	125
6083h	125
6084h	125
608Fh	126
6091h	127
6092h	128
6098h	129
6099h	130
609Ah	131
60B1h	131
60B2h	131
60B8h	132
60B9h	133
60BAh	134
60BBh	134
60BCh	134
60BDh	135
60C0h	135
60C1h	136
60C2h	137
60C4h	138
60D0h	140
60F4h	140
60FDh	141
60FEh	142
60FFh	143
6502h	143

A

Abbreviations	10
AL Event	28

C

CANopen over EtherCAT	32
Control word	116
Control Word Commands	33
Cycle Time	
Adjust	44
Max.Values	44

Cyclical Values	42	Status Word	34
D		Symbols used	9
Document Revisions	144	Synchronization	45
E		T	
EEProm Content	52	Target group	8
Emergency Messages	53	TwinCAT	14
EtherCAT onboard AKD-C	13	W	
EtherCAT Profile	26	Workbench over TwinCAT	18
F			
Fieldbus	51		
Fieldbus Parameters	51		
I			
Interrupt Event	28		
K			
KAS IDE	25		
L			
Latch Words	46		
M			
Mailbox	47		
O			
Object Dictionary AKD-C	58		
Object Dictionary AKD-N	60		
Objects sorted	80		
Operating mode	119		
Operation Modes	44		
P			
PDO Fixed Mapping	35		
PDO Flexible Mapping	37		
Phase run-up	30		
R			
Response monitoring	86		
S			
Setup	14		
Slave Register	27		
Status Machine	32		
Status word	117		

This page intentionally left blank.

About KOLLMORGEN

Kollmorgen is a leading provider of motion systems and components for machine builders. Through world-class knowledge in motion, industry-leading quality and deep expertise in linking and integrating standard and custom products, Kollmorgen delivers breakthrough solutions that are unmatched in performance, reliability and ease-of-use, giving machine builders an irrefutable marketplace advantage.

For assistance with your application needs, visit www.kollmorgen.com or contact us at:

North America

KOLLMORGEN

203A West Rock Road
Radford, VA 24141 USA

Web: www.kollmorgen.com

Mail: support@kollmorgen.com

Tel.: +1 - 540 - 633 - 3545

Fax: +1 - 540 - 639 - 4162

Europe

KOLLMORGEN Europe GmbH

Pempelfurtstraße 1
40880 Ratingen, Germany

Web: www.kollmorgen.com

Mail: technik@kollmorgen.com

Tel.: +49 - 2102 - 9394 - 0

Fax: +49 - 2102 - 9394 - 3155

Asia

KOLLMORGEN

Rm 2205, Scitech Tower, China
22 Jianguomen Wai Street

Web: www.kollmorgen.com

Mail: sales.asia@kollmorgen.com

Tel.: +86 - 400 666 1802

Fax: +86 - 10 6515 0263

KOLLMORGEN[®]

Because Motion Matters™