

IDC

D2000 Series Controls

P/N: PCW-4197 rev. 1.21 07/03

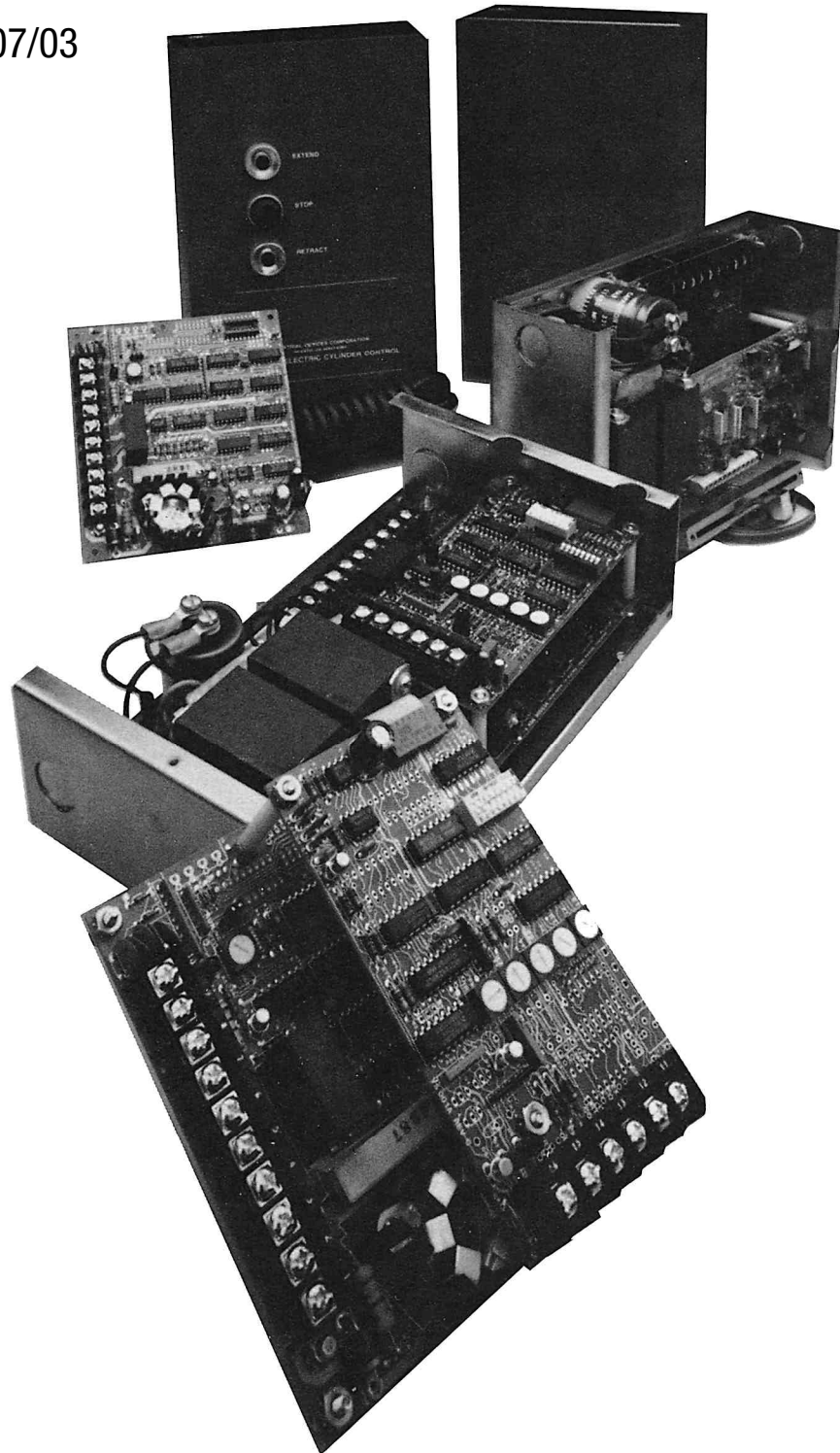

Three levels of sophistication

D2000 Series controls offer three levels of sophistication, from the "basic" D2200 Series to the D2400 and D2500 Series. This manual covers the D2200, D2300 and D2400 Series.

D2200 Series Controls provide basic cylinder control, including:

- Direction switching
- One limit-switch input to control motion
- Automatic protection against overloads

D2300 Series Controls provide the D2200's features, plus:

- Two adjustable speeds for each direction
- A second limit-switch input to control motion
- Open collector outputs to signal that cylinder has stopped

D2400 Series Controls provide the D2300's features, plus:

- Automatic, adjustable time delays

Contents

- Controls for D Series Cylinders**
- Configurations, Specifications, and Mounting Dimensions**
- Installing the Control in Minutes**
- Getting Started**
- Some Common Motion Sequences
- Controlling Other Motion Sequences**
- Wiring the Control Terminals
- Using Dip Switches for Motion Control and Time Delay
- Adjusting the Potentiometers
- A Typical Application**
- Warranty and Repair**
- Troubleshooting**

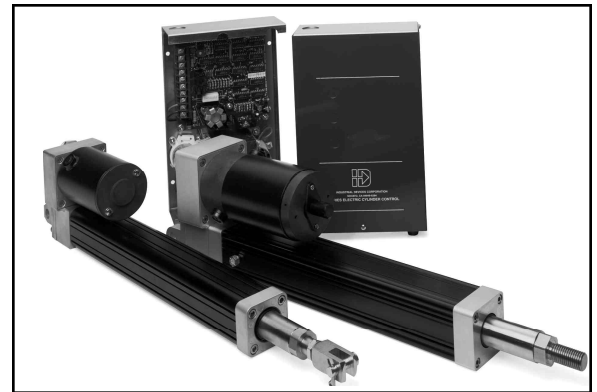

D Series DC Motor Cylinders and Controls

Controls for D Series Cylinders

IDC's D2000 Series controls provide precise motion control for all D Series cylinders. D2000 Series controls feature easy installation and operation, combined with power and sophistication.

IDC controls offer you:

- 24 VDC, 115 VAC or 230 VAC operation
- Compatibility with all D Series cylinders – acme or ball screw
- A variety of configurations
- Stand alone control operation
- Thermally protected power supply
- Optically coupled input for transient protection and noise immunity
- Automatic overload protection to guard your cylinder
- Dynamic braking to ensure accuracy and consistency
- Multiple extensions or retractions within cycle
- Independent adjustments for extend and retract speed, allowing speed changes within cycles
- Pulse width modulated (PWM) speed regulation for smooth operation at low speeds
- Open collector inputs that interface to programmable logic controllers
- 12 VDC logic commands
- Automatic sequencing capability
- Programmable time delays between stops or functions
- Instructions for easy use



D2000 Series Controls

Configurations, Specifications, and Mounting Dimensions

Specifications

Power Requirements

- D2200, D2300 and D2400 +20 to 30 VDC, 10A maximum
- D2201, D2301 and D2401 120 VAC, 50/60 Hz 2A maximum (or)
- Jumper Selectable 208-245 VAC, 50/60 Hz 1A maximum

Inputs

- Extend, retract, stop, LS1, LS2 Optically coupled, pull up to internal 12 VDC.
High level, open circuited +12.25 VDC maximum. Low level, current sinking 0 to .8 VDC at 12 mA maximum
- SP2 10K pull up to 12 VDC

Outputs

- Extend enable, retract enable, extend complete, retract complete, time delay Open collector output, 10K pull up to 12 VDC. High level, open circuited 11.5 VDC typical. Low level, current sinking 0.5 VDC at 100 mA maximum.

Switching: Extend, retract

- Time delay between inputs 0 mseconds minimum
- Low level pulse width (latched input) 5 mseconds minimum

Time Delay Period

0 to 20 seconds

Maximum Motor Temperature

180°F (93°C) on motor case

Variable Speed Reduction

15 to 1 nominal (1/15 of maximum no-load speed)

Nominal Chopping Frequency

2000 Hz

Environmental Temperatures

Operating Temperature 32°F to 122°F (0 to 50°C)
Storage Temperature -40°F to 185°F (-40 to 85°C)

Mounting Dimensions

Model	Length		Width		Depth	
	in.	mm.	in.	mm.	in.	mm.
D2200	5.5	139,7	5.0	127,0	1.2	30,5
D2300	5.5	139,7	5.0	127,0	2.1	53,3
D2400	5.5	139,7	5.0	127,0	2.1	53,3
D2201, D2202	10.0*	254,6*	6.5	165,1	2.9	73,7
D2301, D2302	10.0*	254,6*	6.5	165,1	2.9	73,7
D2401, D2402	10.0*	254,6*	6.5	165,1	2.9	73,7
D2203	10.0*	254,6*	6.5	165,1	3.6	91,4
D2303	10.0*	254,6*	6.5	165,1	3.6	91,4
D2403	10.0*	254,6*	6.5	165,1	3.6	91,4

*Allow 2.25 inches (57,3 mm.) beyond chassis to replace fuse.

Configurations and Model Numbers

D2200

Models

- D2200 Board only
- D2201 Board and power supply, chassis mount
- D2202 Board and power supply, enclosure mount
- D2203 Board and power supply, enclosure mount with push buttons and six foot long power cord

D2300

Models

- D2200 Board only
- D2301 Board and power supply, chassis mount
- D2302 Board and power supply, enclosure mount
- D2303 Board and power supply, enclosure mount with push buttons and six foot long power cord

D2400

Models

- D2400 Board only
- D2401 Board and power supply, chassis mount
- D2402 Board and power supply, enclosure mount
- D2403 Board and power supply, enclosure mount with push buttons and six foot long power cord

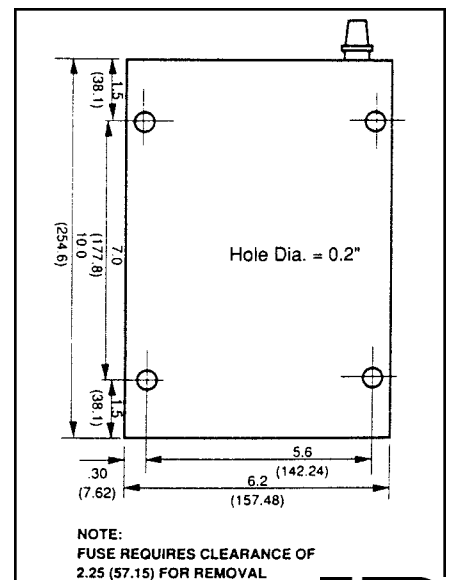

Mounting Diagram



Installing the Control in Minutes

Easy Installation and Operation of Controls for D Series Cylinders

Models 2200, 2300 and 2400

- Connect 24 VDC to terminals #1 and 2. (10AMPS maximum)

FOR ALL OTHER MODELS:

Your control has been completely assembled and tested at the factory.

If you're using 115 VAC input, your control has also been prewired at the factory.

If you're using 230 VAC input, follow these steps:

- Disconnect the jumpers that connect transformer lead #1 to #3, and #2 to #4.
- Connect lead #2 to #3.
- Wire the AC input to the transformer terminals L1 and L2.
- Secure a ground line to the chassis grounding screw.
- Connect cylinder motor wires to control terminals, as described in the next section of this manual, "Getting Started".

Getting Started

Controlling a cylinder with your D2000 Series control is as easy as hooking up a few wires and flipping a couple switches.

First, connect the cylinder to your control using the quick-disconnect cable.

Note: Connect white wire to terminal #4 (M+) and connect black wire to terminal #3 (M-). Don't connect the green wire to anything. Strip it back flush with the wiring insulation. If you don't have a quick-disconnect cord, connect the cylinder's red motor lead to terminal #4 (M+) on the control, and connect the cylinder's black motor lead to terminal #3 (M-) on the control.

Please note that for certain gear ratios or reverse motor mount, the leads to terminals #3 and #4 will need to be reversed for correct extend/retract orientation. The following table indicates which models require lead reversal:

Motor/Orientation	Models Affected
Standard Motor Parallel Mount	TND Series: TND1205A, TND1208A, TND1205B
Standard Motor Reverse Parallel Mount	ALL EXCEPT TND1205A, TND1208A, TND1205B
Inline Motor Parallel Mount	ALL EXCEPT TND1205A, TND1208A, TND1205B
Inline Motor Reverse Parallel Mount	TND1205A, TND1208A, TND1205B

Next, to let your control and cylinder communicate, mount limit switch sensors, called MPS-1 limit switches, to the cylinder, as shown in the photo at left. Be sure to mount sensors on the "right hand" side (as you look at the back) of the cylinder.

FOR PSR-1 and PSR-1Q:

Hook up blue leads of both limit switches to terminal #5 (ground) on the control. Hook up the brown lead of the retract limit switch (that is, the switch at which you want the cylinder to stop in the retract direction) to terminal #9 (LSI). Hook up the other limit switch to terminal #10 (LS2).

**NOTE* Black wire is not used on PSR-1Q.*

FOR RPS-1 and MPS-1:

Hook up black leads of both limit switches to terminal #5 (ground) on the control. Hook up the red lead of the retract limit switch to terminal #9 (LSI). Hook up the other limit switch to terminal #10 (LS2).

NOTE: When you're not using the cylinder, don't leave it in the fully retracted position. That might cause its drive nut to jam. If you do store it retracted, and it does jam, contact the factory.

CYLINDER OPERATION TIP: Always use limit switches to signal the beginning or end of a motion. If you simply let the cylinder retract or extend all the way without using limit switches you risk damaging the cylinder.

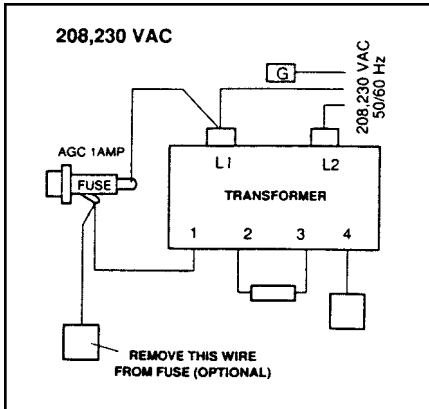

208, 203 VAC wiring diagram

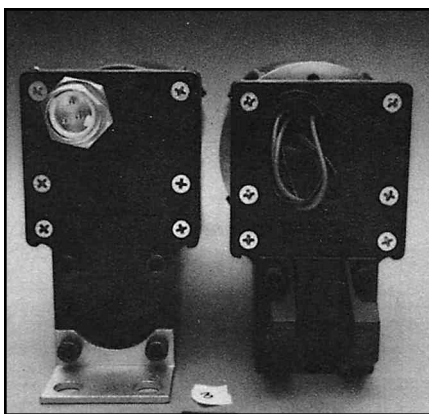

With and without Quick Disconnect



Limit switch sensors mounted to cylinder and wired to control



Now, you're ready to control the cylinder . Here are four of the more common cylinder motions. All begin in the Home position.

Follow the color key specific to your application:		
	RPS & MPS	PSR
COMMON	red	brown
SENSOR INPUT	black	blue

Example #1: Assume you want the cylinder to: **Go out, stop. Come back, stop. Automatically repeat cycle .** (D2200, D2300, D2400)

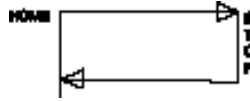

All you need to do is:

- Mount a limit switch sensor at the point you want the cylinder to stop its extension (extend limit switch).
- Mount a second limit switch sensor (retracted position) at the point you want the cylinder to stop its retraction.
- If you are using a D2200 series control, connect the red (or brown) of the extended limit switch sensor to terminal #6 on the control, and the black (or blue) wire to terminal #5. Then, connect the red wire of the retracted position sensor to terminal #7, and the black (or blue) wire to terminal #5.
- If you are using a D2300 or D2400 series control, connect the red (or brown) wire of the extend limit switch sensor to terminal #9 on the control, and the black (or blue) wire to terminal #5 on the control. Then, connect the red (or brown) wire of the retracted position sensor to terminal #10, and the black (or blue) wire to terminal #5.

Turn on dip switch SW1 position #1 to signal the cylinder to retract at the extended limit switch, and turn on dip switch SW1 position #4 to signal the cylinder to extend at the retracted position limit switch.

Turn potentiometer E1 to adjust extension speed. Turn potentiometer RI to adjust retraction speed. In both cases, a clockwise turn creates greater speed.

- With the D2200, D2300 or D2400, turn current sensing potentiometer to adjust the control's sensitivity to resistance from the cylinder. Turning counterclockwise increases sensitivity; too far this way and the control might shut off right after it starts. Turning clockwise decreases sensitivity to resistance, which reduces protection against overloads.
- To start motion, connect a jumper to terminal #7 and the ground terminal #5. Disconnect the jumper when motion begins.
- To stop motion, connect a jumper to terminal #8 and the ground terminal #5.

Note: The word "jumper" as used refers to a wire, stripped at both ends. Usually, a normally-open momentary contact switch is used.

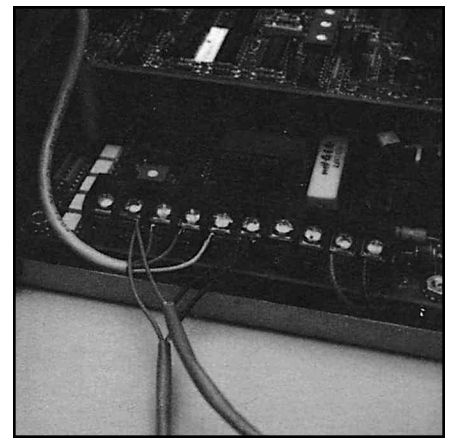

Wires correctly connected for Example #1

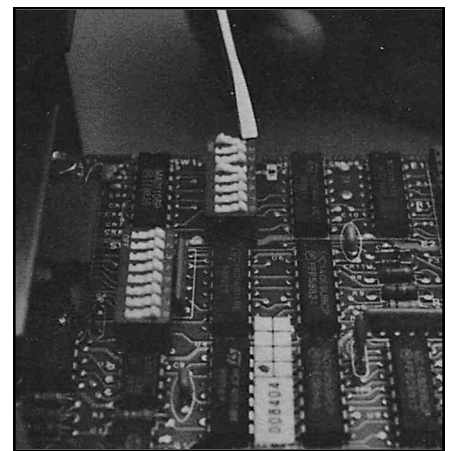

Dip switches in correct position for Example #1

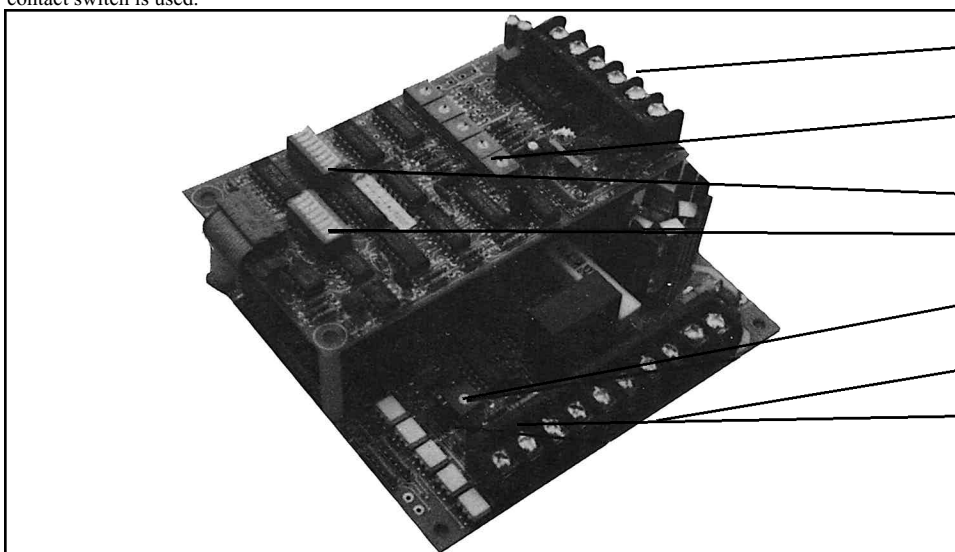

- Terminals
- Potentiometers
- Dip Switches
 - SW1
 - SW2
- Current Sense Potentiometer
- Terminals
- Run/Jog Shunt Block



Installing the Control in Minutes

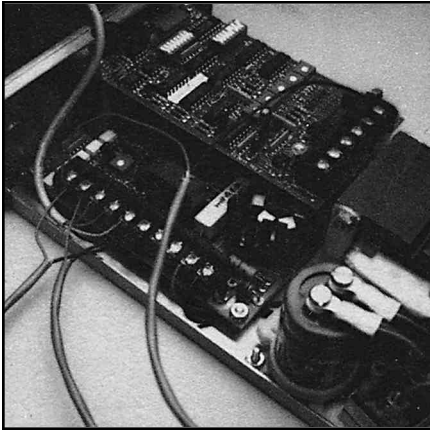

Wires correctly connected for Example #2

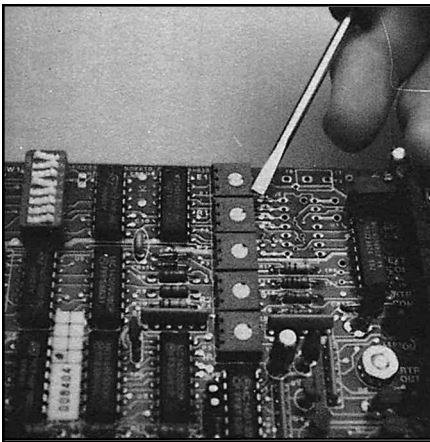

Potentiometer E1 adjusts extension speed, potentiometer R1 adjusts retraction speed

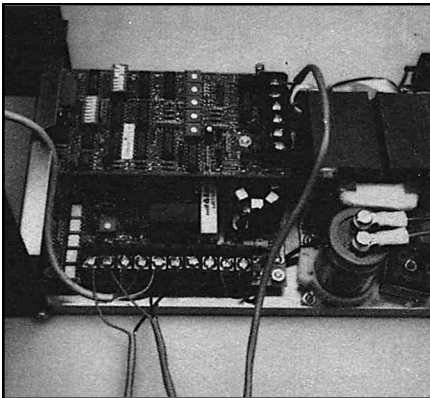

Correct connection for Example #3

Example #2: Assume you want the cylinder to:
Go out, stop. Continue to go out, stop. Come back, stop.
Automatically repeat cycle .
 (D2300 and D2400 only)

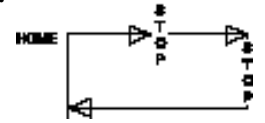

All you need to do is:

- Mount a limit switch sensor at the point you want the cylinder to stop its final extension. Mount a second limit switch sensor at the point you want the cylinder to stop its retraction. Mount a third sensor at the point you want the cylinder to stop its first retraction.
- Connect the red (or brown) wire of the extended position limit switch sensor to terminal #9 on the control, and the black (or blue) wire to terminal #5 on the control. Then, connect the red (or brown) wire of the retract limit switch to terminal #10, and the black (or blue) wire to terminal #5. Connect the red (or brown) wire of the mid-position limit switch to terminal #10 and the black (or blue) wire to terminal #12.

(You use #12 as the ground because you want this limit switch to read only in the Extend direction: that is, you don't want the cylinder to stop at this switch while retracting.)

Turn on dip switch SW1 position #1 to signal the cylinder to retract at the extend limit switch, and turn on dip switch SW1 position #4 on to signal the cylinder to extend at the retract limit switch and mid-position limit switches, both of which are wired into terminal #10.

Turn potentiometer E1 to adjust extension speed. Turn potentiometer R1 to adjust retraction speed. In both cases, a clockwise turn creates greater speed. Turn current sensing

potentiometer to adjust the control's sensitivity to resistance from the cylinder. Turning clockwise decreases sensitivity to resistance, which reduces protection against overloads.

- To start motion, connect a jumper to terminal #7 and the ground terminal #5. Disconnect the jumper when motion begins.
- To stop motion, connect a jumper to terminal #8 and the ground terminal #5.

Example #3: Assume you want the cylinder to:
Go out part way. Continue to go out at different speed, stop.
Come back, stop. Automatically repeat cycle .
 (D2300 and D2400 only)

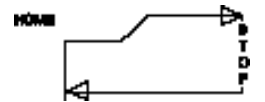

All you need to do is:

- Mount a limit switch sensor at the point you want the cylinder to stop its final extension. Mount a second limit switch sensor at the point you want the cylinder to stop its retraction. Mount a third sensor at the point you want the cylinder to change speed in the extend direction.
- Connect the red (or brown) wire of the extend limit switch sensor to terminal #9 on the control, and the black (or blue) wire to terminal #5 on the control. Then, connect the red (or brown) wire of the retract limit switch to terminal #10, and the black (or blue) wire to terminal #5. Connect the red (or brown) wire of the mid-position limit switch sensor to terminal #11 and the black (or blue) wire to terminal #12.



Set dip switch SW1 position #1 to signal the cylinder to retract at the extend limit switch, and dip switch SW1 position #4 on to signal the cylinder to extend at the mid-position limit switch. Turn potentiometer E1 to adjust extension speed. Turn potentiometer E2 to adjust second extension speed. Turn potentiometer R1 to adjust retraction speed. In each case, a clockwise turn creates greater speed. Turn current sensing potentiometer to adjust the control's sensitivity to resistance from the cylinder. Turning clockwise decreases sensitivity to resistance, which reduces protection against overloads.

- To start motion, connect a jumper to terminal #7 and the ground terminal #5. Disconnect the jumper when motion begins.
- To stop motion, connect a jumper to terminal #8 and the ground terminal #5.

Example #4: Assume you want the cylinder to: **Go out, stop. Come back, stop. Wait five seconds. Automatically repeat cycle .**
(D2400 only)

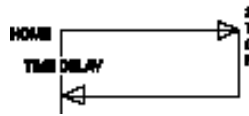

All you need to do is:

- Mount a limit switch sensor at the point you want the cylinder to stop its extension. Mount a second limit switch sensor at the point you want the cylinder to stop its retraction.
- Connect the red (or brown) wire of the extend limit switch sensor to terminal #9 on the control, and the black (or blue) wire to terminal #5 on the control. Then, connect the red (or brown) wire of the retract sensor to terminal #10, and the black wire to terminal #5.

Turn on dip switch SW1 position #1 to signal the cylinder to retract at the first limit switch. **SPORADIC OPERATION WILL RESULT IF SAME OPERATION , OR CONFLICTING OPERATION IS COMMANDED BY BOTH SW1 AND SW2.**

Turn on dip switch SW2 positions #1 and #4 to signal an extension after a time delay at the retract limit switch. Turn on potentiometer P7 to adjust length of time delay. A clockwise turn creates a greater time delay.

Turn potentiometer E1 to adjust extension speed. Turn potentiometer R1 to adjust retraction speed. In both cases, a clockwise turn creates greater speed. Turn current sensing potentiometer to adjust the control's sensitivity to resistance from the cylinder. Turning clockwise decreases sensitivity to resistance, which reduces protection against overloads.

- To start motion, connect a jumper to terminal #7 and the ground terminal #5. Disconnect the jumper when motion begins.
- To stop motion, connect a jumper to terminal #8 and the ground terminal #5.

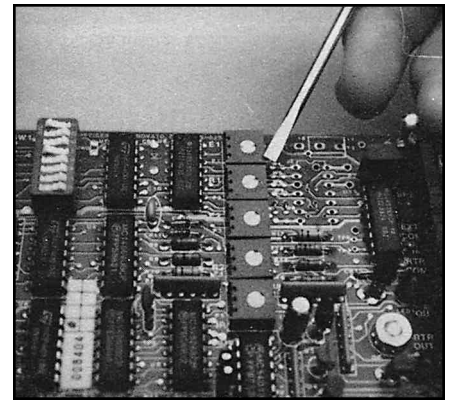

Potentiometers E1 and E2 adjust extension speed; R1 adjusts retraction speed.

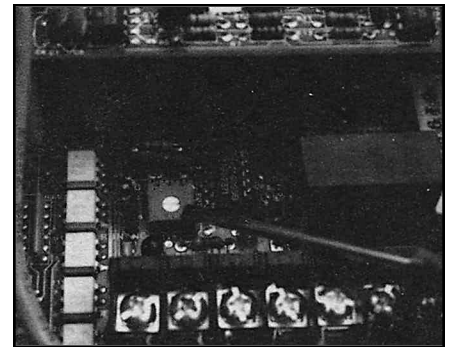

The current sensing potentiometer adjusts sensitivity to resistance from the cylinder (see example #2)

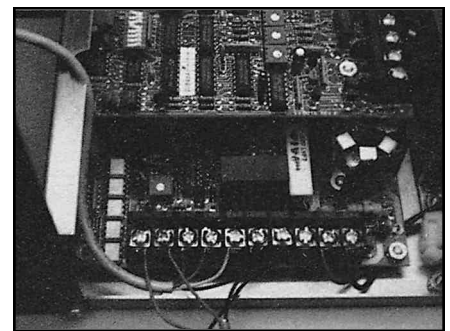

Correct wiring for example #4

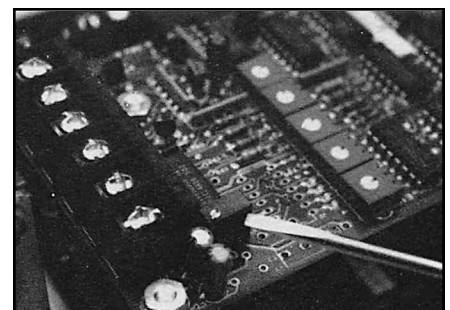

Potentiometer P7 adjusts the length of time delay in example #4.



Controlling Other Motion Sequences

To make the cylinder do things other than those shown in previous examples, simply follow these four steps:

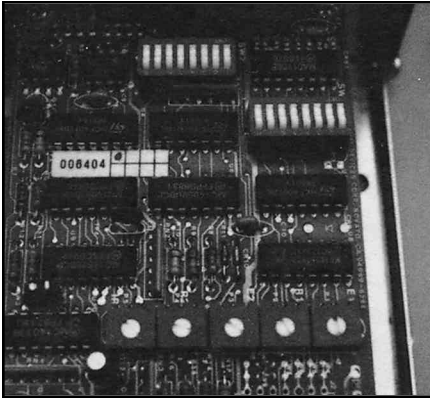

Dip switches SW1 and SW2

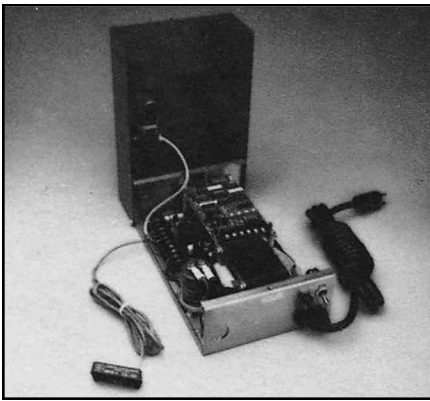

D2403 with limit switch connected.

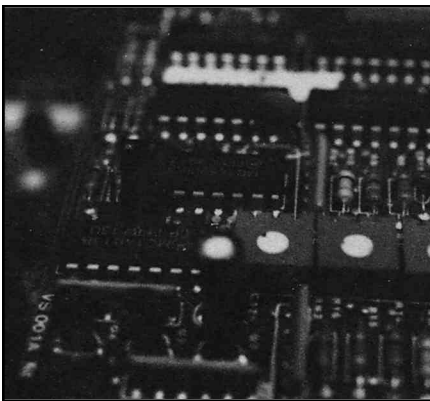

Time delay jumper in W2 position.

Step #1

Wire the limit switch sensors to terminals that control the motions you desire. In each case, remember to ground the sensor on the appropriate ground terminal.

WHAT YOU WANT	WHICH CONTROL YOU NEED	WHAT YOU DO
Run D2400 in place of D2300	D2400	Turn all switches of SW2 off
Cylinder to read a limit switch in both Extend and Retract directions	D2200, D2300 or D2400	Ground limit switch sensor to terminal #5 (also known as "COM")
Cylinder to Retract after stopping	D2200 only	Wire limit switch sensor to terminal #6 ("RTR") and ground terminal #5
Cylinder to Extend after stopping	D2200 only	Wire limit switch sensor to terminal #7 and ground terminal #5
Cylinder to await command from dip switch SW1 or SW2 after stopping at first limit switch	D2300 or D2400	Wire limit switch sensor to terminal #9 ("LS1") and ground terminal #5
Cylinder to await command from dip switch SW1 or SW2 after stopping at second limit switch	D2300 or D2400	Wire limit switch sensor to terminal #10 ("LS2") and ground terminal #5
Cylinder to change speed at limit switch	D2300 or D2400	Wire limit switch sensor to terminal #11 ("SP2") and ground terminal #5
Cylinder to read a limit switch only in the Extend direction	D2300 or D2400	Ground limit switch sensor to terminal #12 ("EXT-COM") and other desired feature's terminal
Cylinder to read a limit switch only in the Retract direction	D2300 or D2400	Ground limit switch sensor to terminal #13 ("RTR-COM") and other desired feature's terminal
Cylinder to communicate to another device that it has completed an extension due to the first limit switch or a current overload	D2300 or D2400	Wire remote device input to terminal #14 ("EXT-OUT") Note: This is a sinking output.
Cylinder to communicate to another device that it has completed a retraction due to the first limit switch or a current overload	D2300 or D2400	Wire remote device input to terminal #15 ("RTR-OUT") Note: This is a sinking output.
Cylinder to communicate to another device that a time delay is in process (connect jumper to two of three positions on W2 side, shown in photo), or that a time delay has been completed (connect jumper to two of three positions on W3).	D2400 only	Wire remote device input to terminal #16 ("TD") Note: This is a sinking output.

Note: You can wire limit switches parallel to one another. For example, if you are using 3 sensors, and want two of them to signal a Stop-and-Extension, wire each into terminals #9 and #5 (ground), and set the appropriate dip switches. If you are using a D2200 Series terminal without dip switches, wire each into terminals #7 and #5.



Step #2

Set the SW1 dip switches (D2300 and D2400 only) to tell the cylinder what to do after stopping at a limit switch sensor .

Limit Switch Functions: D2300 and D2400

A variety of complex motions can be performed with the use of the selected stopping and auto return functions provided by the eight-position SW1 Dip Switch. The normal state for the dip switch is in the open or off position. Closing the appropriate switch enables the function. Refer to the following selection table for dip switch functions.

SW1 Selection Table of Limit Switch Functions

Switch	Function		
1	On	One-shot retract	Triggered by LS1 (Terminal 9)
	Off	One-shot stop	Triggered by LS1
2	On	One-shot extend	Triggered by LS1 (Terminal 9)
	Off	One-shot stop	Triggered by LS1
3	On	One-shot retract	Triggered by LS2 (Terminal 10)
	Off	One-shot stop	Triggered by LS2
4	On	One-shot extend	Triggered by LS2 (Terminal 10)
	Off	One-shot stop	Triggered by LS2
5	Extend complete output (Terminal 14) triggered by:		
	On	Current overload	
6	Retract complete output (Terminal 15) triggered by:		
	On	Current overload	
7	On	After current sensing overload auto retract	
	Off	After current sensing overload stop	
8	On	After current sensing overload auto extend	
	Off	After current sensing overload stop	

Note: Don't turn on SW1 dip switches 1 and 2, or 3 and 4, or 7 and 8 at the same time. The cylinder won't know whether to Extend or Retract.

Step #3

Set the SW2 time delay dip switches (D2400 only) to tell the cylinder what to do after stopping at limit switch sensor .

Time Delay Functions: D2400

The time delay logic has a variety of functions programmed by the Dip Switches on SW2. The normal state for the dip switch is in the open or off position. Closing the appropriate switch enables the function. Refer to the following selection table for dip switch settings.

SW2 Selection Table of Limit Switch Functions

Switch	Function	
1	On	After time delay auto extend
	Off	After time delay auto stop
2	On	After time delay auto retract
	Off	After time delay auto stop
3	On	Time delay triggered by LS1 (Terminal #9)
	Off	Time delay not triggered by LS1
4	On	Time delay triggered by LS2 (Terminal #10)
	Off	Time delay not triggered by LS2
5	On	Time delay triggered by Extend direct current overload
	Off	Time delay not triggered by Extend direct current overload

Terminal #9 (LS1)

Function	Switch/Related Positions
1 One-shot stop	SW1 Switches #1 and #2 off
2 One-shot retract	SW1 Switch #1 on
3 One-shot extend	SW1 Switch #2 on
4 Extend complete output (Terminal #14) triggered	SW1 Switch #5 off
5 Retract complete output (Terminal #15) triggered	SW1 Switch #6 off
6 Time delay triggered	SW2 Switch #3 on

Terminal #10 (LS2)

Function	Switch/Related Positions
1 One-shot stop	SW1 Switches #3 and #4 off
2 One-shot retract	SW1 Switch #3 on
3 One-shot extend	SW1 Switch #4 on
4 Time delay triggered	SW2 Switch #4 on

Terminal #14 (Extend Complete)

Function	Switch/Related Positions
1 Output triggered by Terminal #9	SW1 Switch #5 off
2 Output triggered by current overload	SW1 Switch #5 on



Controlling Other Motion Sequences

Terminal #15 (Retract Complete) Switch/Related Positions

Function	Switch/Related Positions
1 Output triggered by Terminal #9	SW1 Switch #6 off
2 Output triggered by current overload	SW1 Switch #6 on

LED Status

Model	LED Lit	Meaning
D2200, D2300 D2400 Series	Red LED on D2200 bottom board	Motion commanded
D2300, D2400 Series	Red LED on VS001Ab top board adjacent to Ter. #14	Extend motion commanded
D2300, D2400 Series	Red LED on VS001Ab top board adjacent to Ter. #16	Retract motion commanded
D2400 Series	Green LED on VS001ATb top board adjacent to Ter. #16	Time delay triggered

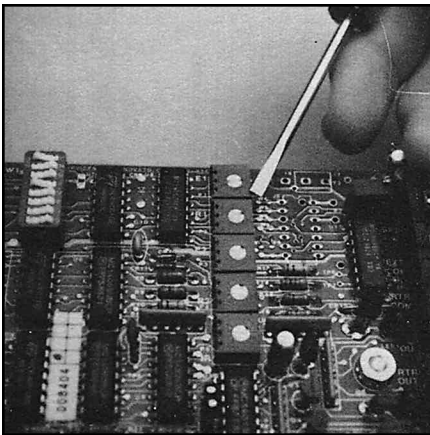

Potentiometer E1 determines cylinder's first extension speed; R1 determines cylinder's first retraction speed.



Step #3 con't.

SW2 Selection Table of Limit Switch Functions

Switch	Function	
6	On	Time delay triggered by Retract direct current overload
	Off	Time delay not triggered by Retract direct current overload
7	On	Time delay only on Extend direction
	Off	Time delay enable
8	On	Time delay only on Retract direction
	Off	Time delay enable

Notes: Don't turn on dip switches 1 and 2, 1 and 5, 2 and 6, or 7 and 8, at the same time. These combinations would give the cylinder conflicting instructions. Automatic extension or retraction after time delays isn't possible if the Jog plug is installed. For more information, see the section in this manual, "Troubleshooting." Don't duplicate commands on SW1 and SW2. For example, setting SW1 dip switch 2 and SW2 dip switch 1 would duplicate the extend-after-stopping command. If switches #1 and #2 are in the "off" position, cylinder will stop after time delay.

Step #4

Adjust potentiometers to control current-sensing (sensitivity to resistance) levels, motion speeds, time delay lengths and sensitivity to speed changes.

What you want

Set level of control's sensitivity to resistance from cylinder

What to do

Turn current-sensing potentiometer counterclockwise for higher sensitivity, clockwise for lower.

Too sensitive a setting may cause the system to stop immediately after it starts.

Not sensitive enough, and you'll reduce the control's protection against overload.

For maximum cylinder life, use limit switches, rather than resistance, to position cylinder stopping points.

(D2300, D2400 only)

Set cylinder's first extension speed

Turn potentiometer E1 clockwise for faster, counterclockwise for slower.

Set cylinder's first retraction speed

Turn potentiometer R1 clockwise for faster, counterclockwise for slower.

Set cylinder's second extension speed

Turn potentiometer E2 clockwise for faster, counterclockwise for slower.

Set cylinder's second retraction speed

Turn potentiometer R2 clockwise for faster, counterclockwise for slower.

Provide for smooth motor action under heavy loads, and full power at low speeds

Turn potentiometer IR. Normally, set IR in full clockwise position. However, if you expect significant changes in load during the cycle, the load may cause speed fluctuations.

In that case, turn IR counterclockwise to increase speed change sensitivity. When the cylinder is operated at very slow speeds, you may need to turn IR counterclockwise to let the current sensor operate.

Turn slowly, and stop when the sensing circuit begins to work, because counterclockwise IR rotation increases speed.

(D2400 only)

Set length of time delay after stop

Turn potentiometer P7 clockwise for longer delay, counterclockwise for shorter delay.

D2000 Series Controls

D2200 Ref. Wiring Diagram

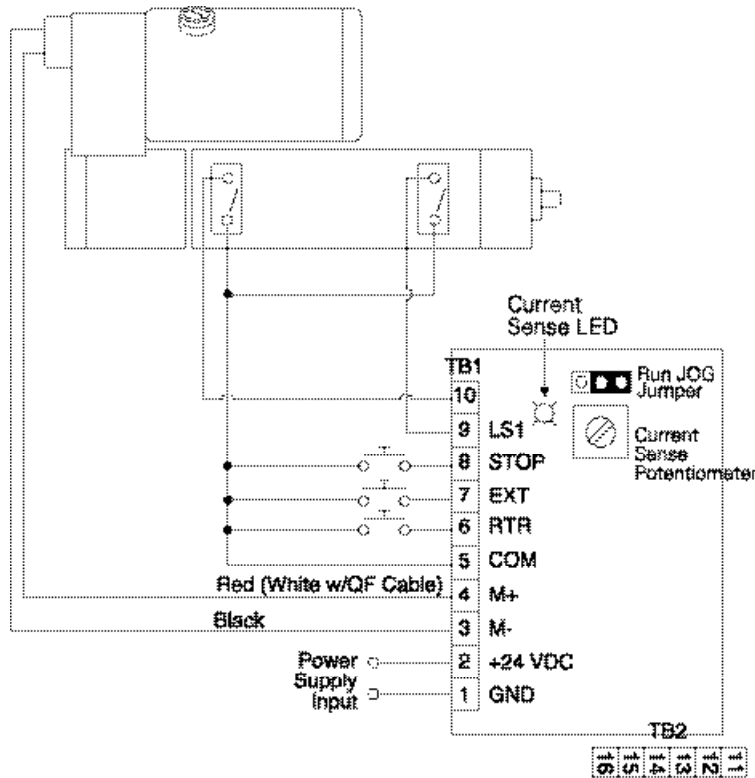

D2300 Ref. Wiring Diagram

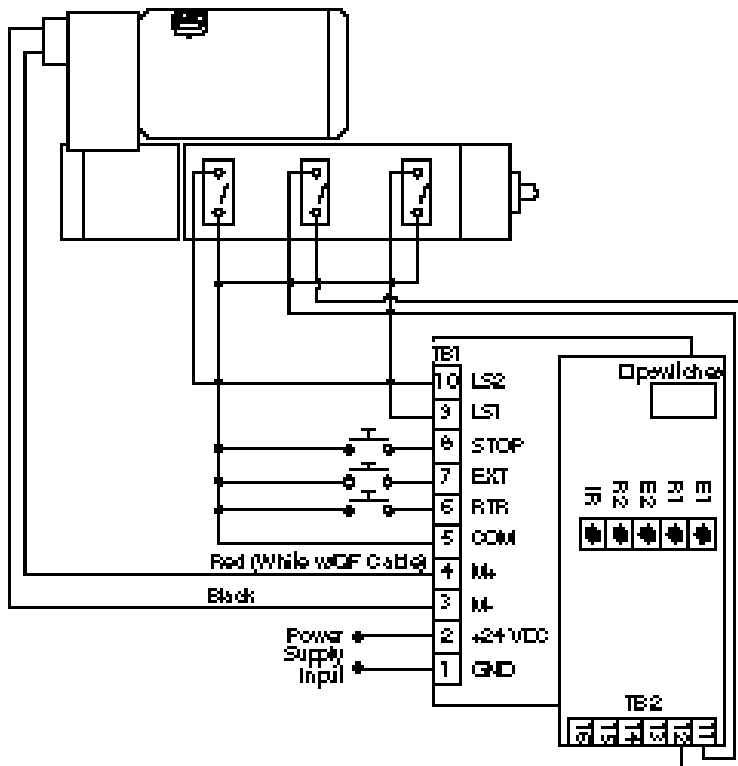

D2000 Series Controls

D2400 Ref. Wiring Diagram

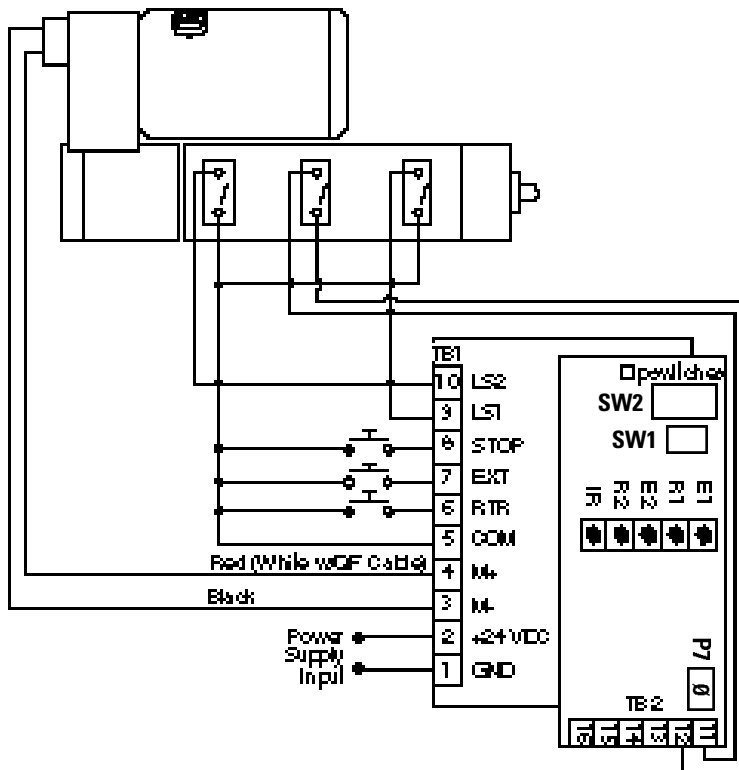

A Typical Application

Application Requirements

The cylinder begins from its home position (retracted position), indexes forward to limit switch, stops, and gives an output to start a welder. Once the welder has finished its operation and has provided an extend signal back to the cylinder control, the cylinder extends again until it hits another limit switch at the extend end of stroke. At this point, the cylinder stops for a five second time delay, then automatically retracts to the home limit switch without stopping at the middle limit switch. Once stopped at home position, the cylinder control outputs to a programmable controller signaling cycle completion. At the appropriate time, the programmable controller signals the cylinder control to begin the cycle again.

Control Type: The D2401 was selected for this application to accommodate the time delay requirement. This control configuration is an open frame chassis version utilizing 120 VAC as its input power.

Cylinder Wiring

Motor: Motor wires are connected to Terminal #3 (black wire), and Terminal #4 (red wire).

Limit Switches: Three limit switches are required. The first limit switch (Home) and the second limit switch must give an output to signal other devices. The third limit switch at the extend end of stroke does not require an output. When signaling outputs from limit switches, LS1 (Terminal #9) must be used, since LS2 does not turn on outputs.

Home Limit Switch: The Home limit switch is wired to Terminals #9 and #5. Terminal #9 is the LS1 input, which when grounded, stops the cylinder and turns on the Extend complete or Retract complete output, depending on the cylinder's travel direction.

Intermediate Limit Switch: Since this limit switch is to operate only in the extend direction, it is wired to Terminals #9 and #12. Terminal #9 is the LS1 input, and Terminal #12 is a ground output present only in the extend direction.

End Limit Switch: The last limit switch must turn on the time delay, but it must not signal the Extend Complete output. Therefore, it is wired to Terminals #10 and #5. Terminal #10 (LS2) will stop the cylinder without affecting the outputs. For the timer, Dip Switch SW2 Positions 1 and 4 are switched to on. No other dip switches need to be on.

Control Wiring

Ter.	Identification	D2200	D2300	D2400
1	Ground	Yes	Yes	Yes
2	+24V	Yes*	Yes*	Yes*
3	Motor-	Yes	Yes	Yes
4	Motor+	Yes	Yes	Yes
5	Common	Yes	Yes	Yes
6	Retract	Yes	Yes	Yes
7	Extend	Yes	Yes	Yes
8	Stop	Yes	Yes	Yes
9	LS #1	Yes	Yes	Yes
10	LS #2	No	Yes	Yes
11	Speed Change	No	Yes	Yes
12	Common-Extend enable**	No	Yes	Yes
13	Common Retract enable**	No	Yes	Yes
14	Extend complete output	No	Yes	Yes
15	Retract complete output	No	Yes	Yes
16	TD output	No	No	Yes

*The +24 volts is supplied by an integral transformer built into the chassis or enclosure. The user can supply either 105-125 or 208-245 VAC to the transformer.

**Terminals 12 and 13 are used with Terminal 11 Speed Change.



Wiring: Input/Output

Extend Input:

The extend input interfaced to a programmable controller requires sinking type logic. Therefore, the programmable controller output must be a dry contact relay output (reed relay, normally-open), a TTL open collector, or an NPN open collector sinking transistor. The interface requires the logic ground from the programmable controller's output module to be connected to Terminal #5. The appropriate output pin from the programmable controller is connected to Terminal #7, the extend input. The welder in the system must also be connected to the extend input. It must have the same specifications as the programmable controller output, or be a normally-open relay contact.

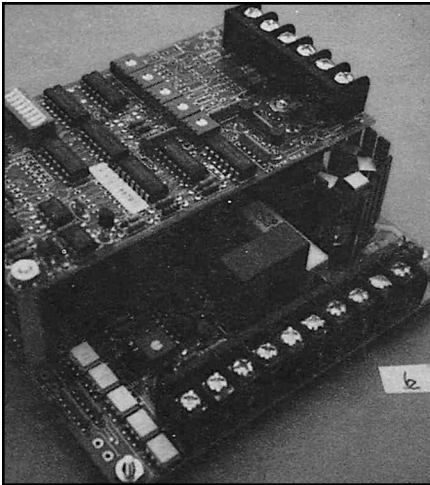

Perspective of diagram at right.

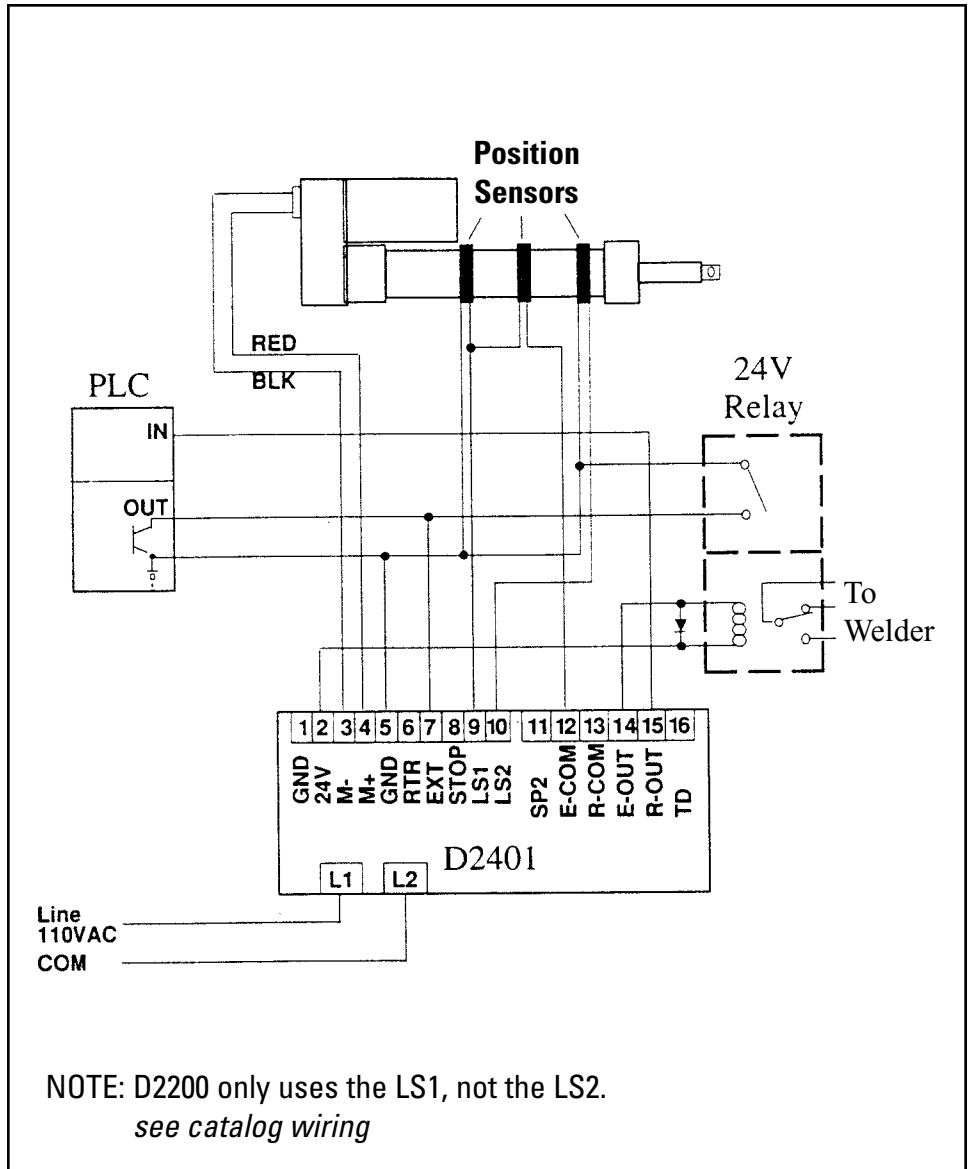

D2000 Series Controls

Output Extend Complete:

Extend Complete output interfaces to the welder. Assuming it requires a 120 VAC input, a relay is required. Since the D2401 logic board is powered by 24 VDC, a 24 VDC relay is used. Connect the 24 volts (Terminal #2), to one side of the coil, and the other side to the Extend Complete Output, Terminal #14. Connect a 1N4001 or equivalent diode across the coil of the relay to protect the Extend Complete Output transistor from high voltage transients generated by the relay coil. (When the relay coil is turned off, a voltage spike in excess of 200 VDC may result, blowing the transistor.) Connect the diode so the cathode (bar side of diode) is connected to the 24 volts. When the cylinder stops and turns the Extend Complete Output on, the relay is energized, and its contacts change state. The 120 VAC is wired to the welder using the relay contacts.

Retract Complete:

The Retract complete output interfaces to programmable controllers. When this input is off, (e.g. when the cylinder is moving or when stopped in the extend direction), the output is 12 VDC, via a 10K resistor pull-up. When the output is on, it is at approximately 0.2 VDC, low true, capable of sinking 100 mA. The interface to the programmable controller can be direct to a DC module or through an external relay. When interfacing to a programmable controller's DC module, make sure it is compatible to low voltage DC signals, such that signals above 10 VDC are one state, and below 1 VDC are another. If the programmable controller's input module requires power from the D2401, use the unregulated 24 VDC power (typically 28 VDC) from Terminal #2. If the input logic requires more than 12 VDC, then an external 10K pull-up resistor can be used between Terminals #2 and #15 (Retract Complete output). Connect the D2401 Retract Complete output from Terminal #15 to the programmable controller's input. If a relay interface is required, follow the same procedures as you did for the Extend Complete output above.

Dip Switches

SW1

SW1 Dip Switches set the limit switches and outputs to specific operations. Turn all of these switches off for this application.

SW2

SW2 Dip Switches set the time delay functions. Turn on Positions 2 and 4 only. Position 2 enables auto retract after time delay and Position 4 enables the timer to be started when the cylinder is stopped by LS2, Terminal #10. As an option, Position 7 may be turned on. It allows the timer to be started only while moving in the extend direction.



Warranty

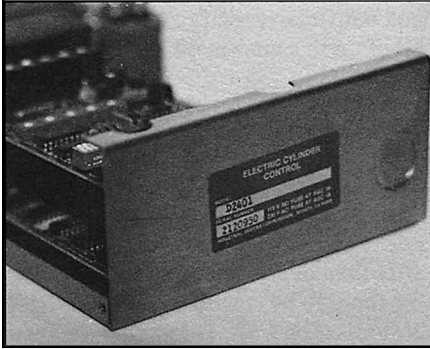

In the event of failure, get the serial number from your unit, and follow the steps at the right.

All IDC branded products are fully tested before they're shipped to you. However, it's possible that defects will be discovered later. If this should occur, Danaher Motion offers the following limited warranty:

Danaher Motion warrants all electrical cylinders and electronic controllers to be free of defects in materials and workmanship for a period of one year from date of shipment to the end user. Products returned prepaid to Danaher Motion will be repaired or replaced at Danaher Motion's option at no charge, and returned prepaid to the user. Products that have expended their useful life in less than one year, or have been improperly used or damaged, in the opinion of Danaher Motion, are not subject to the terms of this warranty.

Danaher Motion maintains a repair facility for all units which are IDC manufactured, including a complete inventory of parts to ensure quick service turnaround.

In Case of Failure

In the event of a drive failure, you should:

1. Get the serial number of the defective unit.
2. If the unit is out of warranty, prepare a purchase order for the repair cost.
3. Call Danaher Motion for a return authorization number.
Call (815) 226-2222.

4. Ship the unit prepaid to:
Danaher Motion
600 Martin Ave., Suite 103
Rohnert Park, CA 94928
Attn: RMA # _____



Troubleshooting

Symptom	Cause	Remedy
Cylinder doesn't move	Power off	Check AC voltage
	Fuse blown	Replace fuse: If 115 VAC, use fuse AGC 2A If 230 VAC, use fuse AGC 1A
	No DC power at control	Check DC voltage at terminals #1 and #2. The power supply is bad unless #1 = GND and #2 = 22-30 VDC.
	Speed setting too low (D2300 and D2400 only)	Increase speed potentiometers by turning them clockwise.
	Inputs continuously grounded	Check for ground on terminal #6, #7, #8, or #10. Remove ground.
	No motor power	Make sure you've given an Extend or Retract signal. Then, check for voltage between Terminals #3 and #4. Still no voltage – call Danaher Motion IDC (800) 277-1066
	Open circuit between D2200 and motor	Check wiring to motor leads
Cylinder lunges forward and stops	Current sensing potentiometer (on D2200 board) set too low	Increase setting by turning clockwise
	Jog plug installed	Remove Jog plug from D2200 board, and place it over "Run" pins. "Run" means the cylinder needs to be jumped momentarily to begin automatic motions. "Jog" position dictates that the cylinder stops as soon as the motion signal stops.
Cylinder only runs in one direction	Component failure	Call Danaher Motion IDC (800) 277-1066
Motor temporarily hums, but cylinder doesn't move	Mechanical bind or jam causing overload.	Check for misaligned Installation.
	Over-torqued thrust tube deforming drive nut	Call Danaher Motion IDC (800) 277-1066
	Drive nut jammed against thrust-bearing due to thrust tube not being seated against drive nut flange	Call Danaher Motion IDC ((800) 277-1066
	Cylinder's drive belt jammed because cylinder was stored in full retract position	Contact the factory IDC (800) 277-1066

Notes:

If control turns motor on and then off due to current sensing overload, the control is probably working properly. The problem is an overload (too much resistance from cylinder). To check for overload: Install a 0-10 Amp ammeter in series with the motor and read current while running. Maximum dynamic current should be less than 4.5 amps with no load applies to the cylinder and 8 amps at full load.

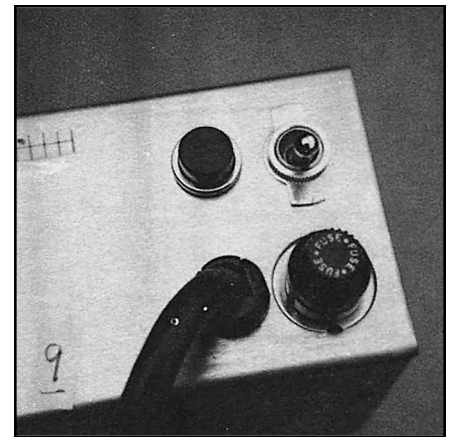

Power switches

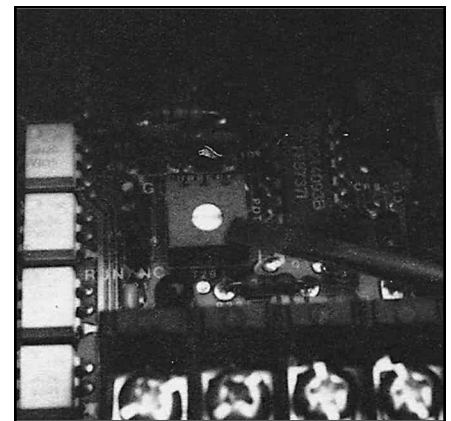

Current sensing potentiometer

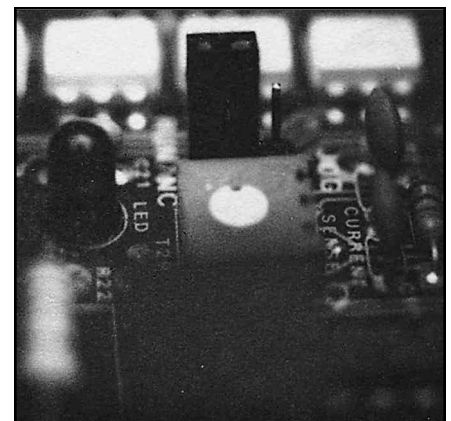

Jog plug placed over "Run" pins



Notes



07/2003 300 Printed in USA P/N: PCW-4197 rev. 1.21

