

AKM[®] 2G

English **Instruction Manual**
Deutsch **Betriebsanleitung**
Italiano **Manuale di Istruzioni**
Español **Manual de Instrucciones**
Français **Manuel d'Installation**
Русский **Руководство по эксплуатации**

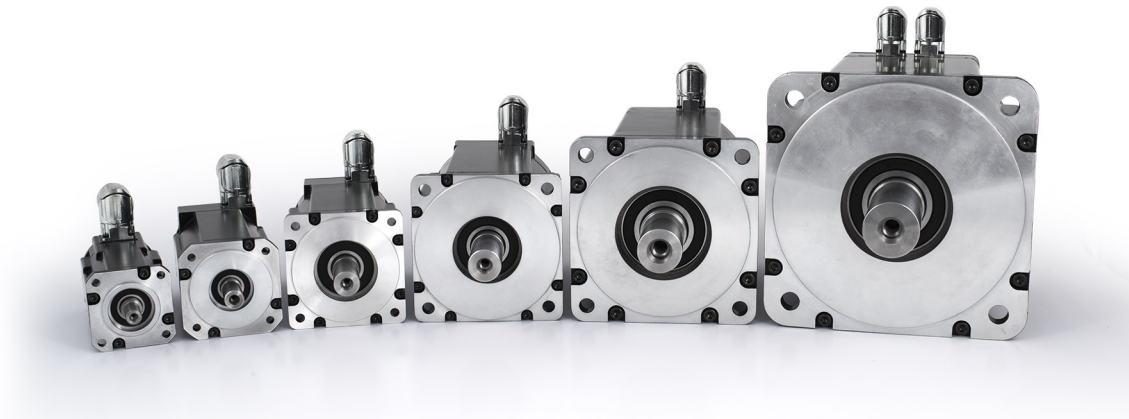

Edition: D, August 2020

Part Number: 903-900000-99

European Version (CE region)

 English  Deutsch  Italiano  Español  Français  Русский

Original Language is English. All other content is translated from the original language.









For safe and proper use, follow these instructions.
Keep them for future reference.

Record of Document Revisions

Revision	Date	Remarks
A	04/2018	Initial release, first edition
B	08/2018	DSL Feedback
C	05/2019	EnDat Feedback, updates, and corrections
D	07/2020	Add Low Voltage models; updates & corrections

Table of Contents

	Instructions Manual	English	→ p. 3	Technical Data	→ p. 171
	Betriebsanleitung	Deutsch	→ p. 29	Dimension Drawings	→ p. 337
	Manuale di Istruzioni	Italiano	→ p. 57	Connector Pinout	→ p. 355
	Manual de Instrucciones	Español	→ p. 85	Approvals	→ p. 361
	Manuel d'Installation	Français	→ p. 115		
	Руководство по эксплуатации	Русский	→ p. 143		

Trademarks

1. AKM is a registered trademark of Kollmorgen Corporation
2. EnDat is a registered trademark of Dr. Johannes Heidenhain GmbH
3. HIPERFACE is a registered trademark of Max Stegmann GmbH
4. HIPERFACE DSL® is registered trademark of SICK STEGMANN GmbH.
5. SpeedTec is a registered trademark of TE Connectivity Industrial GmbH

Technical changes to improve the performance of the equipment may be made without prior notice!

Printed in the Czech Republic. All rights reserved. No part of this work may be reproduced in any form (by photocopying, microfilm or any other method) or stored, processed, copied or distributed by electronic means without the written permission of Kollmorgen Europe GmbH.

Technische Änderungen, die der Verbesserung der Geräte dienen, vorbehalten!

Gedruckt in der Tschechische Republik. Alle Rechte vorbehalten. Kein Teil des Werkes darf in irgendeiner Form (Fotokopie, Mikروفilm oder in einem anderen Verfahren) ohne schriftliche Genehmigung der Firma Kollmorgen Europe GmbH reproduziert oder unter Verwendung elektronischer Systeme verarbeitet, vervielfältigt oder verbreitet werden.

Il produttore si riserva la facoltà di apportare modifiche tecniche volte al miglioramento degli apparecchi

Stampato nella Czech Republic. Tutti i diritti riservati. Nessuna parte di questo documento può essere rielaborata, riprodotta in qualsiasi forma (fotocopia, microfilm o altro processo) o diffusa mediante l'uso di sistemi elettronici senza l'approvazione scritta della ditta Kollmorgen Europe GmbH o rielaborata, riprodotta o diffusa mediante l'uso di sistemi elettronici.

Reservado el derecho de introducir modificaciones técnicas para la mejora de los equipos

Impreso en la Czech Republic. Reservados todos los derechos. Prohibida la reproducción total o parcial de la presente obra por cualquier medio (fotocopia, microfilm u otros), así como su procesamiento, reproducción y divulgación por medio de sistemas electrónicos, sin expresa autorización escrita de la empresa Kollmorgen Europe GmbH.

Toutes modifications techniques concourant pour l'amélioration des appareils réservées !

Imprimé en Czech Republic. Tous droits réservés. Aucune partie de l'ouvrage ne peut être reproduite sous quelque forme que ce soit (imprimée, photocopiée, microfilmée ou par un autre procédé) ou encore traitée, reproduite ou diffusée au moyen de systèmes électroniques sans autorisation écrite préalable de Kollmorgen Europe GmbH.

Сохраняется право вносить технические изменения, служащие для совершенствования устройств!

Напечатано в Czech Republic. Все права защищены. Без письменного согласия фирмы Kollmorgen Europe GmbH запрещается воспроизводить какие бы то ни было части данного руководства в любой форме (в печатной, в виде фотоконии, микрофильма или другим способом), а также обрабатывать, размножать или распространять их с использованием электронных систем.

1 English

1.1 General	4
1.1.1 About this manual	4
1.1.2 Abbreviations used	4
1.1.3 Symbols Used	4
1.2 Safety	5
1.2.1 You should pay attention to this	5
1.2.2 Use as directed	7
1.2.3 Prohibited use	7
1.2.4 Handling	8
1.3 Package	10
1.3.1 Delivery package	10
1.3.2 Nameplate	10
1.3.3 Model number description AKM2G	11
1.4 Technical Description	16
1.4.1 General technical data	16
1.4.2 Standard features	16
1.4.3 Wiring technology	20
1.4.4 Holding brake	21
1.5 Mechanical Installation	22
1.5.1 Important Notes	22
1.6 Electrical Installation	23
1.6.1 Important notes	23
1.6.2 Guide for electrical installation	24
1.6.3 Connection of the motors with preassembled cables	24
1.7 Setup	25
1.7.1 Important notes	25
1.7.2 Guide for setup	26
1.7.3 Trouble Shooting	27
1.8 Definition of Terms for Technical Data	28

1.1 General

1.1.1 About this manual

This manual describes the AKM@2G series of synchronous servomotors (standard / low voltage versions). The motors are operated in drive systems together with Kollmorgen servo amplifiers. Please observe the entire system documentation, consisting of:

- Instructions manual for the servo amplifier
- Manual Bus Communication (e.g. CANopen or EtherCAT)
- Online help of the amplifier's setup software
- Regional accessories manual
- Technical description of the AKM2G series of motors







More background information can be found on the Kollmorgen Developer Network, available at kdn.kollmorgen.com.

1.1.2 Abbreviations used

NOTE

Abbreviations used for technical data see chapter "Definition of terms" → p. 28.
In this document, the symbolism (→ # 53) means: see page 53.

1.1.3 Symbols Used

Symbol	Indication
 DANGER	Indicates a hazardous situation which, if not avoided, will result in death or serious injury.
 WARNING	Indicates a hazardous situation which, if not avoided, could result in death or serious injury.
 CAUTION	Indicates a hazardous situation which, if not avoided, could result in minor or moderate injury.
NOTICE	Indicates situations which, if not avoided, could result in property damage.
NOTE	This symbol indicates important notes.
	Warning of a danger (general). The type of danger is specified by the text next to the symbol.
	Warning of danger from electricity and its effects.
	Warning of danger from hot surface.
	Warning of suspended loads.

1.2 Safety

This section helps you to recognize and avoid dangers to people and objects.

1.2.1 You should pay attention to this

Specialist staff required!

Only properly qualified personnel are permitted to perform such tasks as transport, assembly, setup and maintenance. Qualified specialist staff are persons who are familiar with the transport, installation, assembly, commissioning and operation of motors and who bring their relevant minimum qualifications to bear on their duties:

- Transport: only by personnel with knowledge of handling electrostatically sensitive components.
- Mechanical Installation: only by mechanically qualified personnel.
- Electrical Installation: only by electrically qualified personnel.
- Setup: only by qualified personnel with extensive knowledge of electrical engineering and drive technology

The qualified personnel must know and observe IEC 60364 / IEC 60664 and national accident prevention regulations.

Read the documentation!

Read the available documentation before installation and commissioning. Improper handling of the motor can cause harm to people or damage to property. The operator must therefore ensure that all persons entrusted to work on the motor have read and understood the manual and that the safety notices in this manual are observed.

Pay attention to the technical data!

Adhere to the technical data and the specifications on connection conditions (rating plate and documentation). If permissible voltage values or current values are exceeded, the motors can be damaged, for example by overheating.

Perform a risk assessment!

The manufacturer of the machine must generate a risk assessment for the machine, and take appropriate measures to ensure that unforeseen movements cannot cause injury or damage to any person or property. Additional requirements on specialist staff may also result from the risk assessment.

Transport safely!

Lift and move motors with more than 20 kg weight (AKM2G7) only with lifting tools. Lifting unassisted could result in back injury. Always observe the hints on [Transport](#)

Secure the key!

Remove any fitted key (if present) from the shaft before letting the motor run without coupled load, to avoid the dangerous results of the key being thrown out by centrifugal forces. When delivered, the key is protected with a plastic cap.

Hot surface!



The surfaces of the motors can be very hot in operation, according to their protection category. Risk of minor burns! The surface temperature can exceed 100°C. Measure the temperature, and wait until the motor has cooled down below 40°C before touching it.

Earthing! High voltages!



It is vital that you ensure that the motor housing is safely earthed to the PE (protective earth) busbar in the switch cabinet. Risk of electric shock. Without low-resistance earthing no personal protection can be guaranteed and there is a risk of death from electric shock.

Not having optical displays does not guarantee an absence of voltage. Power connections may carry voltage even if the motor shaft is not rotating.

Do not unplug any connectors during operation. There is a risk of death or severe injury from touching exposed contacts. Power connections may be live even when the motor shaft is not rotating. This can cause flashovers with resulting injuries to persons and damage to the contacts.

After disconnecting the servo amplifier from the supply voltage, wait several minutes before touching any components which are normally live (e.g. contacts, screw connections) or opening any connections.

The capacitors in the servo amplifier can still carry a dangerous voltage several minutes after switching off the supply voltages. To be quite safe, measure the DC-link voltage and wait until the voltage has fallen below 60 V.

Secure hanging loads!



Built-in holding brakes do not ensure functional safety!

The user should consider required local safety standards in the case of hanging loads (vertical axes) and the need to insure personnel safety by using additional safety measures for hazard avoidance.

1.2.2 Use as directed

- The AKM2G series of synchronous servomotors is designed especially for drives for industrial robots, machine tools, textile and packing machinery and similar with high requirements for dynamics.
- The user is only permitted to operate the motors under the ambient conditions which are defined in this documentation.
- The AKM2G series of motors is **exclusively** intended to be driven by servo amplifiers under speed and / or torque control.
- The motors are installed as components in electrical apparatus or machines and can only be commissioned and put into operation as integral components of such apparatus or machines.
- The thermal sensor which is integrated in the motor windings must be observed and evaluated.
- The holding brakes are designed as standstill brakes and are not suited for repeated operational braking.
- The conformity of the servo system to the standards mentioned in the CE Declaration of Conformity [Approvals](#) is only guaranteed when the components (servo amplifier, motor, cables etc.) that are used have been supplied by Kollmorgen.

1.2.3 Prohibited use

- The use of the **Standard** Motors is prohibited
 - directly on mains supply networks,
 - in areas where there is a risk of explosions,
 - in contact with food and beverage,
 - in environments with caustic and/or electrically conducting acids, bases, oils, vapors, dusts.
- Commissioning the motor is prohibited if the machine in which it was installed
 - does not meet the requirements of the EC Machinery Directive,
 - does not comply with the EMC Directive,
 - does not comply with the Low Voltage Directive.
- Built-in holding brakes without further equipment must not be used to ensure functional safety.

1.2.4 Handling

1.2.4.1 Transport

- Climate category 2K3 according to IEC 60721-3-2, EN61800-2
- Temperature: -25...+70°C, max. 20K/hr change
- Humidity: rel. humidity 5% - 95% , no condensation
- Only by qualified personnel in the manufacturer's original recyclable packaging
- Avoid shocks, especially to the shaft end
- If the packaging is damaged, check the motor for visible damage. Inform the carrier and, if appropriate, the manufacturer.

Transport of motors with a weight of more than 20kg

Lifting eyes must be used to safely transport AKM2G7 motors (> 20kg). Observe any transport instructions included in the packaging of the motor.

We recommend the transport tool ZPZM 120/292 for moving the motors.

Suspension Unit ZPMZ 120/292 consists of a beam, suspended to the crane hook and two double-run chain suspenders.



DANGER

Suspended load. Risk of death if load falls. Never step under the load, while the motor is raised.

- The fastening screws of the lifting eyes must be fully screwed in.
- The lifting eyes must be positioned on the supporting surface in an even and flat manner.
- Prior to use, check the lifting eyes for secure fitting and any obvious damages (corrosion, deformation).
- Lifting eyes with deformations must not continue to be used.

B1/ 4 x Lifting Bolt Plus Lifting Beam

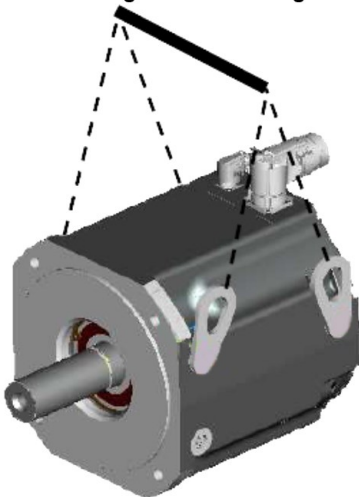

B2/ 2 x Lifting Bolt Plus Lifting Beam

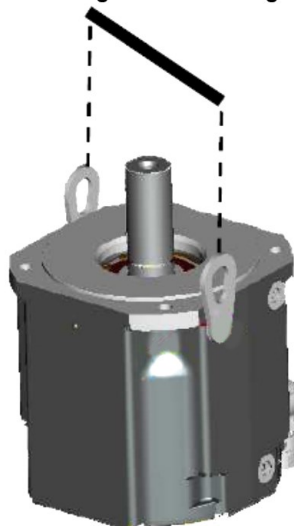

B3/ 2 x Lifting Bolt Plus Lifting Beam

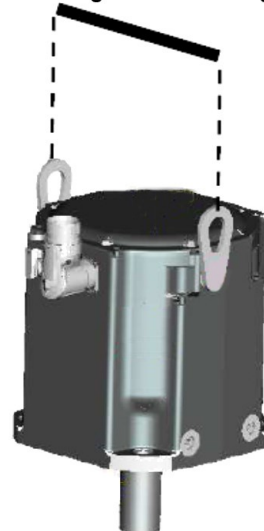

1.2.4.2 Packaging

- Cardboard packing with Instapak® foam cushion.
- You can return the plastic portion to the supplier (see "Disposal").

Motor type	Packing	Max. stacking height
AKM2G2	Cardboard	10
AKM2G3	Cardboard	6
AKM2G4	Cardboard	6
AKM2G5	Cardboard	5
AKM2G6	Cardboard	1
AKM2G7	Cardboard	1

1.2.4.3 Storage

- Climate category 1K4 according to IEC 60721-3-1, EN61800-2
- Storage temperature: - 25...+55°C, max. variation 20K/hr.
- Humidity: rel. humidity 5% - 95%, no condensation
- Store only in the manufacturer's original recyclable packaging
- Max. stacking height: see table in chapter "Packaging"
- Storage time: unlimited

1.2.4.4 Maintenance / Cleaning

- Maintenance and cleaning only by qualified personnel
- The ball bearings should be replaced after 20,000 hours of operation under rated conditions (by the manufacturer).
- Check the motor for bearing noise every 2500 operating hours, respectively each year. If any noises are heard, stop the operation of the motor, the bearings must be replaced (by the manufacturer).
- Opening the motor invalidates the warranty.
- If the housing is dirty, clean housing with Isopropanol or similar, do not immerse or spray

1.2.4.5 Repair / Disposal

Repair of the motor must be done by the manufacturer. Opening the motor invalidates the warranty. In accordance to the WEEE-2012/19/EG-Guidelines we take old devices and accessories back for professional disposal, if the transport costs are taken over by the sender. Send the motor to:

Kollmorgen s.r.o.

Attn.: Repair Department

Evropska 864

664 42 Modrice / Czech Republic

Email: brno_customer_repairs@kollmorgen.com

Phone: +420 533 314 455

1.3 Package

1.3.1 Delivery package

- Motor from the AKM2G series
- Product manual (multi language) printed, one per delivery

1.3.2 Nameplate

With standard motors the nameplate is adhesive on the housing side.

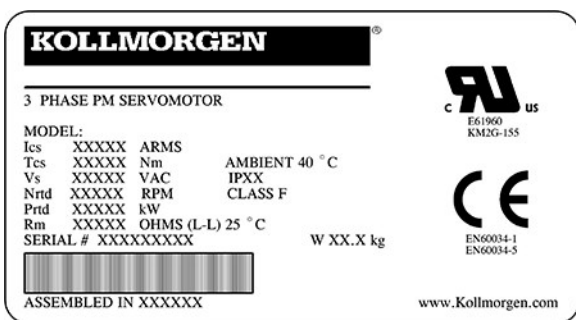
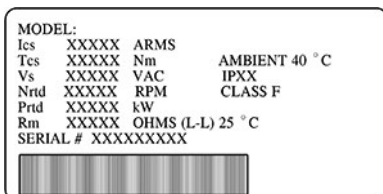

Legend	Description
MODEL	motor type
Ics	standstill current
Tcs	standstill torque
Vs	U _N (supply voltage)
Nrtd	nn (rated speed @ Un)
Prtd	Pn (rated power)
Rm	R25 (winding resistance @ 25°)
SERIAL	serial no.
AMBIENT	maximum ambient temp.
W	Motor weight in kg
IPXX	Ingress Protection Rating
CLASS F	Insulation Rating

Year of manufacturing is coded in the serial number: the first two digits of the serial number are the year of manufacturing, e.g. "17" means 2017.

1.3.3 Model number description AKM2G

1.3.3.1 Part number scheme

Use the part number scheme for product identification only, not for the order process, because not all theoretical combinations of features are possible.

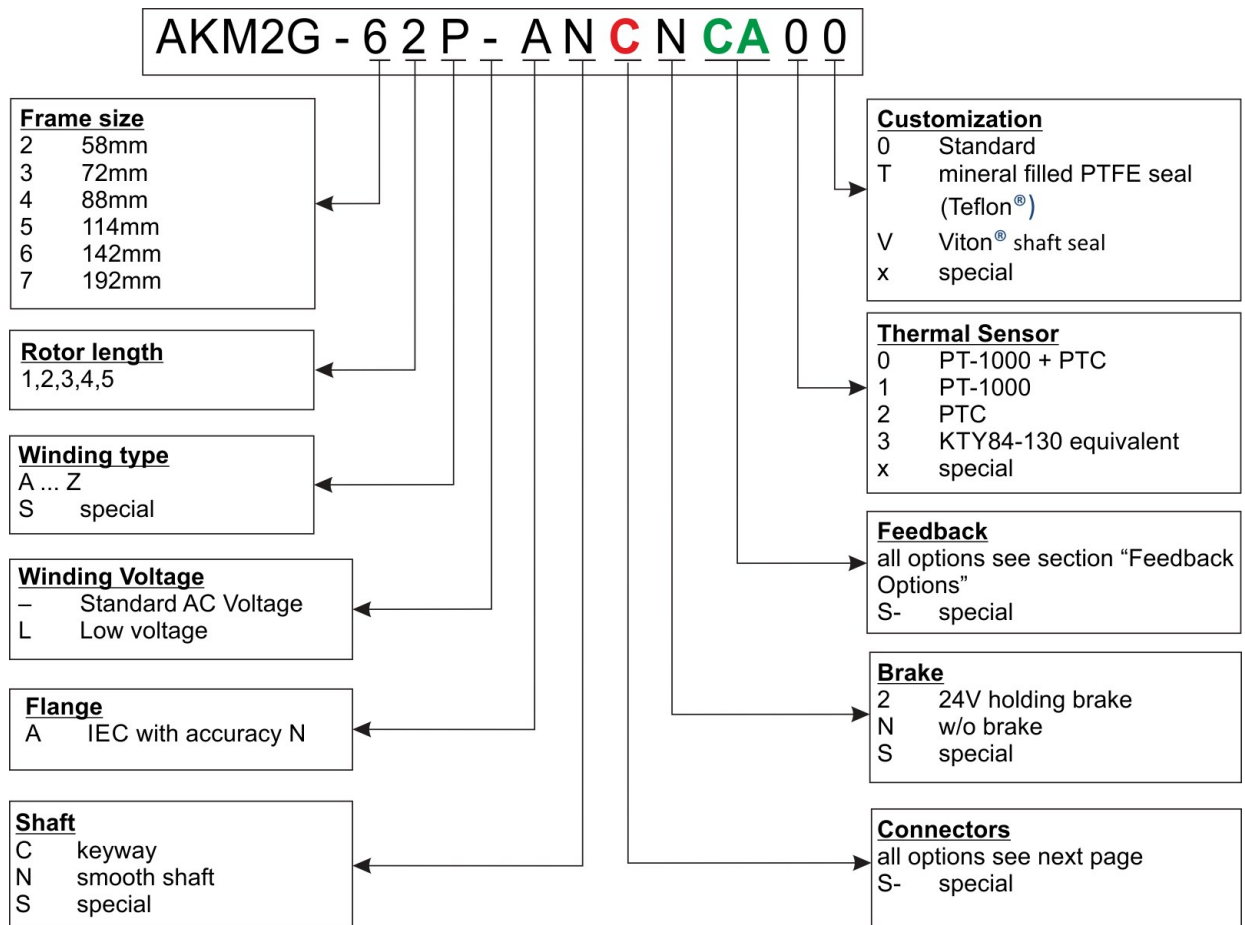

1.3.3.2 Connector Options (C)

Pinout for the connector options are listed in chapter "Connector Pinout" from [Connector Pinout](#).

1.3.3.3.1 Connector Description

Connector	Usage*	Contacts - Pins	max. Current [A]	max. Cross Section [mm ²]	Protection Class	Cable Power Conductor Size (mm ²)	Suggested mating connector
		Power/Signal	Power/Signal	Power/Signal			
M23 SpeedTec right angle connectors (Size 1)	Power & Brake	4 / 5	20 / 10	4 / 1.5	IP65	1.5	BSTA-082-FR-46-58-0100-000
						2.5	BSTA-082-FR-46-58-0100-000
						4.0	BSTA-082-FR-32-59-0100-000
	Resolver	- / 12	- / 10	- / 0.5	IP65	-	ASTA-013-FR-01-62-0100-000
	Encoder	- / 17	- / 10	- / 0.5	IP65	-	ASTA-014-FR-01-61-0100-000
	Hybrid (SFD3)	4 / 5	20 / 10	4 / 1.5	IP65	1.5	BSTA-082-FR-46-58-0100-000
						2.5	BSTA-082-FR-46-58-0100-000
						4.0	BSTA-082-FR-32-58-0100-000
	Hybrid (DSL)	4 / 5	20 / 10	4 / 1.5	IP65	1.5	H51A-425-FR-14-58-0100-000 + 40.A711.00
						2.5	H51A-425-FR-14-58-0100-000 + 40.A711.00
						4.0	H51A-425-FR-15-59-0100-000 + 40.A711.00
	Hybrid (EnDat)	4 / 5	20 / 10	4 / 1.5	IP65	1.5	H51A-405-FR-14-59-0100-000 + 40.A702.00
						4.0	H51A-405-FR-15-59-0100-000 + 40.A702.00

Connector	Usage*	Contacts - Pins	max. Current [A]	max. Cross Section [mm ²]	Protection Class	Cable Power Conductor Size (mm ²)	Suggested mating connector
		Power/Signal	Power/Signal	Power/Signal			
M40 (Size 1.5)	Power & Brake	4 / 5	75 / 30	16 / 4	IP65	4.0	CSTA-265-FR-06-26-0020-000
						6.0	CSTA-265-FR-06-25-0020-000
						10.0	CSTA-265-FR-06-25-0020-000
	Hybrid (SFD3)	4 / 5	75 / 30	16 / 4	IP65	4.0	CSTA-265-FR-06-26-0020-000
						6.0	CSTA-265-FR-06-25-0020-000
						10.0	CSTA-265-FR-06-25-0020-000
	Hybrid (DSL)	4 / 5	75 / 30	16 / 4	IP65	4.0	H81A-501-FR-03-44-0100-000 + 40.A711.00
						6.0	H81A-501-FR-03-45-0100-000 + 40.A711.00
	y-tec	Power & Brake	4 / 5	14 / 3.6	1.5 / 0.75	IP65	1.5
Feedback		- / 12	- / 5	- / 0.75	IP65		ESTB-002-FR-02-32-0001-000

Hybrid (SFD3) means Power and SFD3 Feedback (plus brake) on the same connector and in one cable.

Hybrid (DSL) means Power and DSL Feedback (plus brake) on the same connector and in one cable.

Hybrid (EnDat) means Power and EnDat Feedback (plus brake) on the same connector and in one cable.

1.3.3.4.2 Connector Designation - Motor

Model Designation	Connection	Usable with	Position of connection
C	2 Speedtec M23	AKM2G3 - AKM2G7 ≤ 20 Amps	Angular, rotatable, motor mounted
D*	1 Hybrid M23	AKM2G2 - AKM2G7 ≤ 20 Amps	Angular, rotatable, motor mounted
G	2 Speedtec M23	AKM2G3 - AKM2G7 ≤ 20 Amps	Straight, motor mounted
H	1 M40 Power, 1 M23 Feedback	AKM2G7 > 20 Amps	Angular, rotatable, motor mounted
J*	1 Hybrid Connector M40	AKM2G7 > 20 Amps	Angular, rotatable, motor mounted
Y	1 Y-Tec Connector	AKM2G2	Rotatable, motor mounted

* Hybrid connectors valid for SFD3, DSL, and EnDat only.

1.3.3.5 Feedback Options (CA)

Motor length depends on the built-in feedback device, see dimension diagrams from [Dimension drawings](#).

Retrofitting is not possible. Pinout for the connector options are listed [Connector Pinout](#).

1.3.3.6.1 Feedback Description

Code	Description	Motor ID Support 3	Accuracy 1,2 (arc-sec)	RMS Noise 1 (arc-sec)	Remarks	Resolution	Absolute Revs	Compatible Drives	Functional Safety Support 4
CA	SFD3	Yes	±585"	±9.9"	Inductive	24 bits	1	AKD family	No
GU	Hiperface DSL	Yes	±240"	±20"	Capacitive	17 bits	4096	AKD family	up to SIL2 7,9
LD 5	EnDat 2.2	Yes	±120"	See Note 6 below	Inductive	19 bits	4096	AKD family	up to SIL310
			±65"						
R-	Resolver	No	±540"	N/A	Inductive	24 bits for AKD	1	All	No
2- 8	Commutating Encoder	No	+/-218.2"	N/A	Optical	12 bits	none	AKD family	

- AKD drives have a resolver measurement accuracy of ±45", for a drive w/ motor accuracy of ±585" and RMS Noise of ±9.9".
- Accuracy refers to overall system accuracy once installed in the motor. Noise refers to the RMS position noise when at stand-still.
- Motor ID support means electronic motor nameplate data is included, allowing for plug-and-play commissioning.
- SIL rating of device as supplied by the feedback manufacturer. Customer is responsible for the machine Functional Safety Rating.
- For EnDat feedback motors acceleration of the motor is limited to $\leq 1 \cdot 10^5$ rad/s². The connected servo drive may further limit this value.
- This information was not available at the time of printing, Please contact Kollmorgen Customer Support for the latest update.
- For motors serial number 1935100001 or later.
- Available only on Low Voltage motors AKM2G3 and above.
- Refer to the manufacturer's website (link below) for specific information regarding the functional safety specifications of this feedback. The "Safety-related parameters" section contains specific information on the product's safety characteristics. Other sections provide additional details. www.sick.com/us/en/motor-feedback-systems/motor-feedback-systems-rotary-hiperface-dsl/eeseem37/eem37-2kf0a017a/p/p486170
Website information and links are current as of the issue date of this manual. Alternatively, search the site for product #1067125.
- For specific information regarding the functional safety specifications of this feedback refer to the manufacturer's website listed below. www.heidenhain.com/en_US/products/rotary-encoders/without-integral-bearing/
On this page select the correct document link for the feedback used in the AKM2G.

AKM2G size	Manufacturer Model #	General Safety Information	Model Specific Information
frame size 2-4	EQI 1131	pages 28-29	pages 72-75
frame size 5-7	EQI 1331	pages 28-29	pages 78-79

Website information and links are current as of the issue date of this manual. Alternatively, search the site for model number above.

1.3.3.7.2 Available Connector Options by Feedback Choice*SFD3*

Connector Type	Compatible AKM2Gx	Type
D	AKM2G2-4	Size 15
D	AKM2G5-7 ≤ 20A	Size 21
J	AKM2G7 > 20A	Size 21

Hiperface DSL

Connector Type	Compatible AKM2Gx	Type
D	AKM2G2-7 ≤ 20A	EEM37
J	AKM2G7 > 20A	EEM37

EnDat 2.2

Connector Type	Compatible AKM2Gx	Type
D	AKM2G2-4	EQI 1131
D	AKM2G5-7 ≤ 20A	EQI 1331

Resolver

Connector Type	Compatible AKM2Gx	Type
Y	AKM2G2	Size 15
C / G	AKM2G3-4	Size 15
C / G	AKM2G5-7 ≤ 20A	Size 21
H	AKM2G7 > 20A	Size 21

Commutating Encoder

Connector Type	Compatible AKM2Gx	Type
C / G	AKM2G3-4	Size 15

1.4 Technical Description

1.4.1 General technical data

Ambient temperature (at rated values) 5...+40°C for site altitude up to 1000m amsl
It is vital to consult our applications department for ambient temperatures above 40°C and encapsulated mounting of the motors.

Permissible humidity (at rated values) 95% rel. humidity, no condensation

Power derating (currents and torques) 1%/K in range 40°C...50°C up to 1000m amsl
for site altitude above 1000m amsl and 40°C
6% up to 2000m amsl
17% up to 3000m amsl
30% up to 4000m amsl
55% up to 5000m amsl
No derating for site altitudes above 1000m amsl with temperature reduction of 10K / 1000m

Ball-bearing life ≥ 20.000 operating hours

NOTE

Technical data for every motor type can be found in chapter "Technical Data" from [Technical Data](#).

1.4.2 Standard features

1.4.2.1 Style

The basic style for the AKM2G motors is style IM B5 according to EN 60034-7.

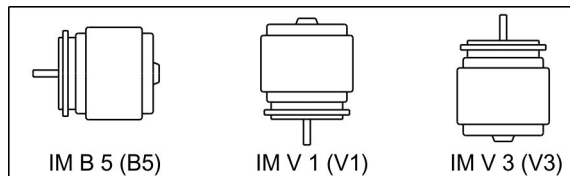

1.4.2.2 Flange

IEC flange accuracy according to DIN 42955. Tolerances of shaft extension run-out and of mounting flanges for rotating electrical machines.

Code	Flange
A	IEC with accuracy N, fit AKM2G2-7: j6

1.4.2.3 Protection class

Per EN 60529.

Standard Motor	Connector Option	Shaft Seal	Protection class
AKM2G2-AKM2G7	C, D, G, H, J, Y	without	IP54
AKM2G2-AKM2G7	C, D, G, H, J, Y	with	IP65

1.4.2.4 Insulation material class

The motors are supplied with insulation material class F according to IEC 60085 (UL1446 class F).

1.4.2.5 Surface

The motors are coated with epoxy powder coating in matte black. This finish is not resistant against solvents (e.g. trichlorethylene, nitro-thinners, or similar).

1.4.2.6 Shaft end, A-side

Power transmission is made through the cylindrical shaft end A, fit k6 to EN 50347, with a locking thread but **without a fitted keyway**.

Motors are also available with keyway and inserted key according to DIN 6885. The shaft with keyway is balanced with short (half) key.

Bearing life is calculated with 20.000 operating hours.

Order code	Shaft end	Available for
N	Smooth shaft	AKM2G 2-7
C	Keyway, closed	AKM2G 2-7

Radial force

If the motors drive via pinions or toothed belts, then high radial forces will occur. The permissible values at the end of the shaft may be read from the diagrams in chapter "Drawings" from [Dimension drawings](#). The maximum values at rated speed you will find at the technical data from [Technical Data](#). Power take-off from the middle of the free end of the shaft allows a 10% increase in F_R .

Axial force

When assembling pinions or wheels to the axis and use of e.g. angular gearheads axial forces arise. The maximum values at rated speed are found in the technical data.

Coupling

Double-coned collets have proved to be ideal zero-backlash coupling devices, combined, if required, with metal bellows couplings. Shaft center hole per DIN 332 Form D.

1.4.2.7 Shaft seal

If AKM2G is connected to a machine flange with unsealed shaft region, then the shaft seal (option "T" or "V") ensures the shaft sealing.

- The "T" seal option is made of mineral filled PTFE seal (Teflon®) which is self-lubricating and is recommended for applications where regular lubrication of the shaft seal is not possible.
- The "V" seal option is made of Viton® and is recommended for applications where regular lubrication of the shaft seal occurs such as lubricated gear boxes.
- The shaft seal ensures the IP65 protection for the shaft area.
- The rated performance is achieved after some hours of shaft seal run-in. No special procedure for run-in is needed.
- Some "shedding" of the shaft seal material, particularly the Teflon material®, is normal and does not affect the function.
- Shaft seal is pre-lubricated by grease.

1.4.2.8 Protective Device

The Standard AC voltage version of each motor is fitted with an electrically isolated PT-1000+ PTC. The Low Voltage version of each motor is fitted with an electrically isolated PT-1000. The thermal sensors do not provide any protection against short, heavy overloading.

The motor can be delivered with a PT-1000 +PTC, PT-1000, PTC, or KTY 84-130 equivalent sensors optionally (see [Thermal Device Options : Resistance vs. Temperature Graphs](#) options 0, 1, 2, and 3).

With digital feedback systems SFD3 (CA), Hiperface DSL (GU), and EnDat 2.2 (LD) the temperature sensor status is transmitted digitally and evaluated in the drive.

Provided that our configured feedback cables are used, the sensor is integrated into the monitoring system of the digital servo amplifiers.

1.4.2.9.1 Thermal Device Options : Resistance vs. Temperature Graphs

Thermal Device Option curves show the equivalent resistance in ohms that corresponds to a given temperature of the motor windings. The drive used with the motor must support the selected thermal device for proper operation.

Thermal Device Option 0

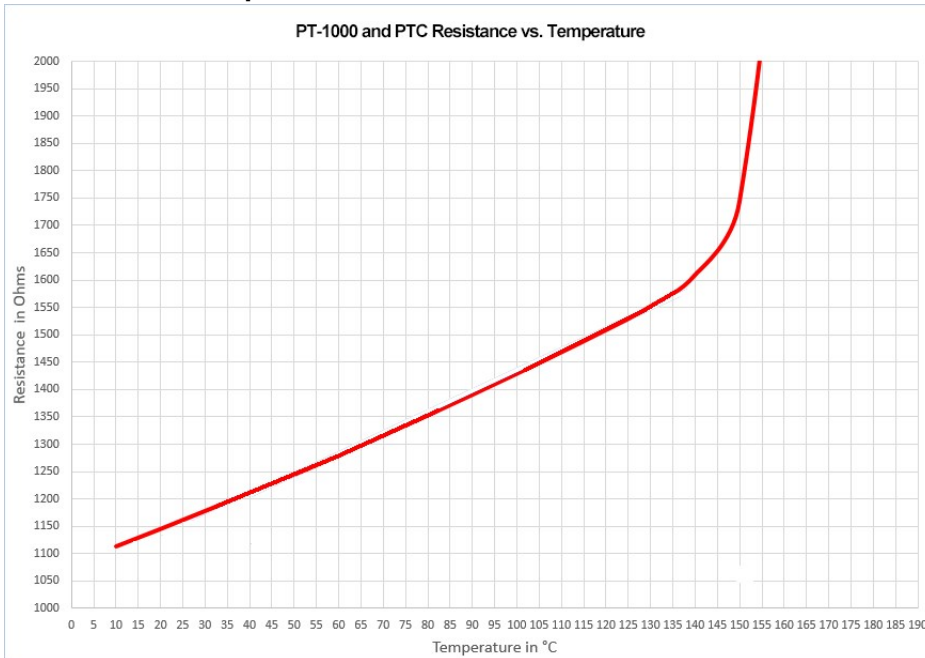

Thermal Device Option 1

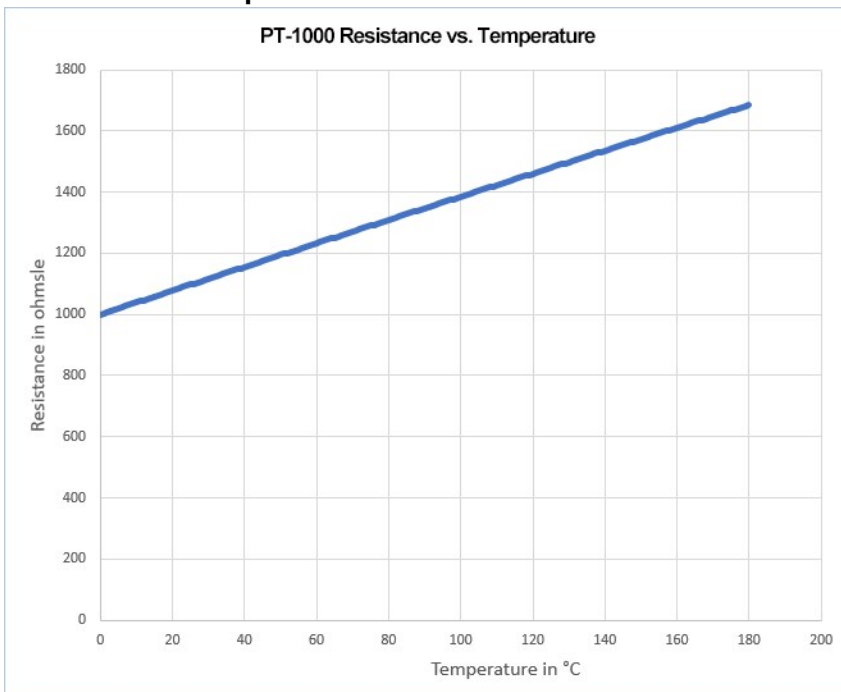

Thermal Device Option 2

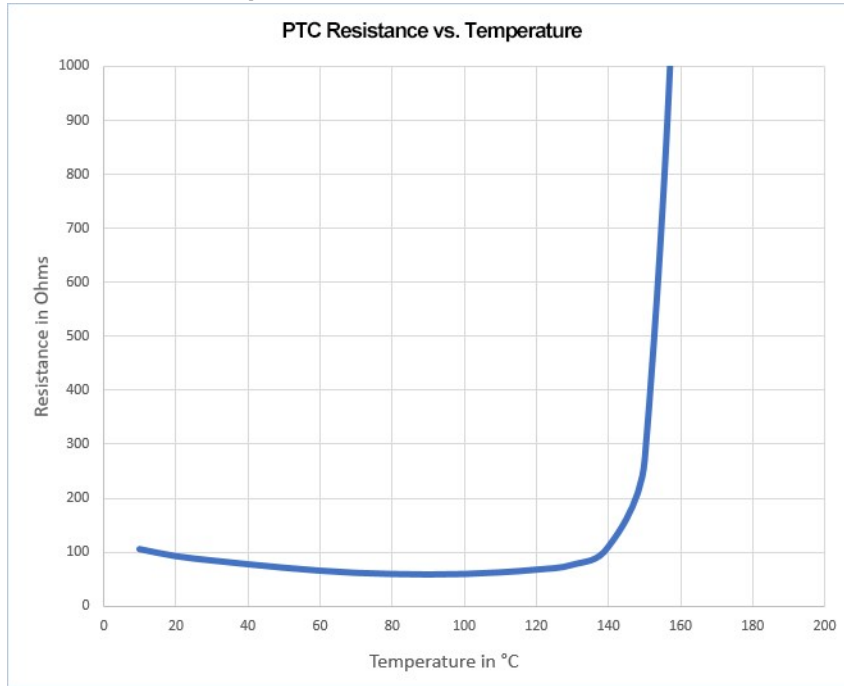

Thermal Device Option 3

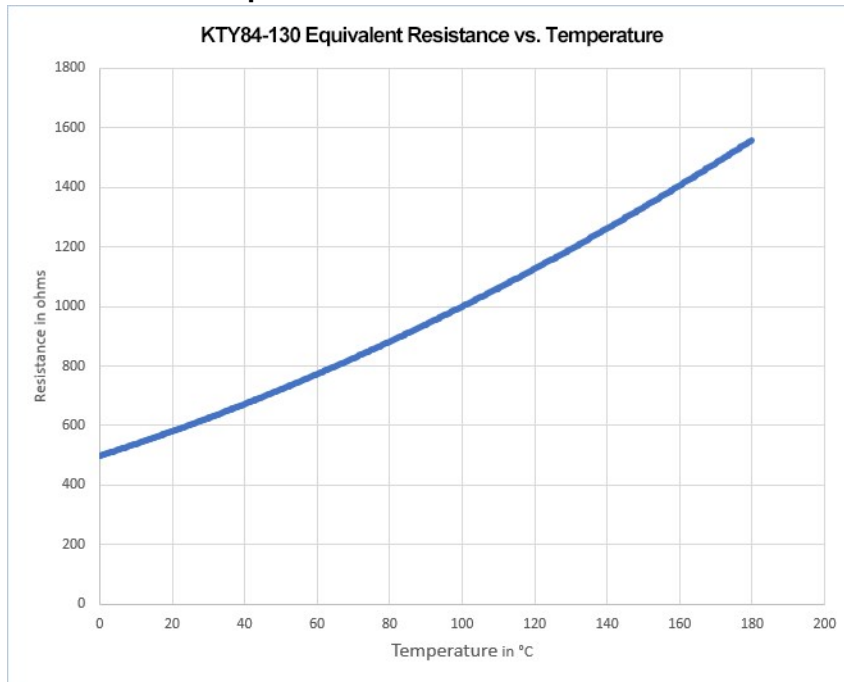

1.4.2.10 Vibration class

The motors are made to vibration class A according to EN 60034-14. For a speed range of 600-3600 rpm and a shaft center between 56-132 mm, this means that the actual value of the permitted vibration severity is 1.6 mm/s.

Velocity [rpm]	max. rel. Vibration Displacement [μm]	max. Run-out [μm]
≤ 1800	90	23
> 1800	65	16

1.4.3 Wiring technology

1.4.3.1 Connectors

Descriptions of the available connectors: [Connector Options \(C\)](#). Connector pinout: from [Connector Pinout](#).

1.4.3.2 Wire cross sections

(Wire cross-sections for 40C ambient.)

Power Cable, Combi Cable

Combi cables contain 4 power lines and 2 additional lines for motor holding brake control.

Cross Section		Current Carrying Capacity	Remarks
Cable	Combi Cable		
(4x1)	(4x1+(2x0.75))	$0\text{A} < I_{0\text{rms}} \leq 10.1\text{A}$	The brackets (...) show the shielding. Current carrying capacity acc. to EN60204-1:2006 Table 6, Column B2
(4x1.5)	(4x1.5+(2x0.75))	$10.1\text{A} < I_{0\text{rms}} \leq 13.1\text{A}$	
(4x2.5)	(4x2.5+(2x1))	$13.1\text{A} < I_{0\text{rms}} \leq 17.4\text{A}$	
(4x4)	(4x4+(2x1))	$17.4\text{A} < I_{0\text{rms}} \leq 23\text{A}$	
(4x6)	(4x6+(2x1))	$23\text{A} < I_{0\text{rms}} \leq 30\text{A}$	
(4x10)	(4x10+(2x1.5))	$30\text{A} < I_{0\text{rms}} \leq 40\text{A}$	
(4x16)	(4x16+(2x1.5))	$40\text{A} < I_{0\text{rms}} \leq 54\text{A}$	
(4x25)	(4x25+(2x1.5))	$54\text{A} < I_{0\text{rms}} \leq 70\text{A}$	

Feedback Cable

Type	Cross Section	Remarks
Resolver	(4x2x0.25)	
Encoder	(4x2x0.25)	

Hybrid Cable

Type	Cross Section	Remarks
SFD3/DSL	(4x1.0+(2x0.34)+(2x0.75))	4 power lines & 2 brake lines & 2 signal lines for SFD3/DSL 6 signal lines for EnDat 2.2
SFD3/DSL	(4x1.5+(2x0.34)+(2x0.75))	
SFD3/DSL	(4x2.5+(2x0.34)+(2x1.0))	
SFD3/DSL	(4x4.0+(2x0.34)+(2x1.0))	
SFD3/DSL	(4x6.0+(2x0.34)+(2x1.0))	
EnDat 2.2	(4x1.5 + (2x0.75) + (2x (2x0.14) + (2x0.25)))	
EnDat 2.2	(4x4.0 + (2x1.0) + (2x (2x0.14) + (2x0.25)))	

1.4.4 Holding brake

All motors are optionally available with a holding brake. A spring applied brake (24V DC) is integrated into the motors. When this brake is de-energized it blocks the rotor.



WARNING

If there is a suspended load (vertical axes), the motor's holding brake is released, and, at the same time, the servo drive does not produce any output, the load may fall down! Risk of injury exists for the personnel operating the machine. The user should consider required local safety standards in the case of hanging loads (vertical axes) and the need to insure personnel safety by using additional safety measures for hazard avoidance.

NOTICE

The holding brakes are designed as standstill brakes and are not suited for repeated operational braking. In the case of frequent, operational braking, premature wear and failure of the holding brake is to be expected.

The motor length increases when a holding brake is mounted.

The holding brake can be controlled directly by the servo amplifier (no personal safety !), the winding is suppressed in the servo amplifier — additional circuitry is not required (see instruction manual of the servo amplifier). If the holding brake is not controlled directly by the servo drive, additional wiring (e.g. varistor) is required. Consult our support department.

Brake data are listed in chapter "Technical Data Brakes" from [Technical Data Brakes](#) .

1.5 Mechanical Installation

NOTE

Dimension drawings can be found in chapter "[Dimension drawings](#)".

1.5.1 Important Notes

NOTE

Only qualified staff with knowledge of mechanical engineering are permitted to assemble the motor.

- Protect the motor from unacceptable stresses. During transport and handling no components must be damaged.
- The site must be free of conductive and aggressive material. For V3-mounting (shaft end upwards), make sure that no liquids can enter the bearings.
- Ensure an unhindered ventilation of the motors and observe the permissible ambient and flange temperatures. For ambient temperatures above 40°C please consult our applications department beforehand. Ensure that there is adequate heat transfer in the surroundings and the motor flange.
- Motor flange and shaft are especially vulnerable during storage and assembly - so avoid brute force. It is important to use the locking thread which is provided to tighten up couplings, gear wheels or pulley wheels and warm up the drive components, where possible. Blows or the use of force will lead to damage to the bearings and the shaft.

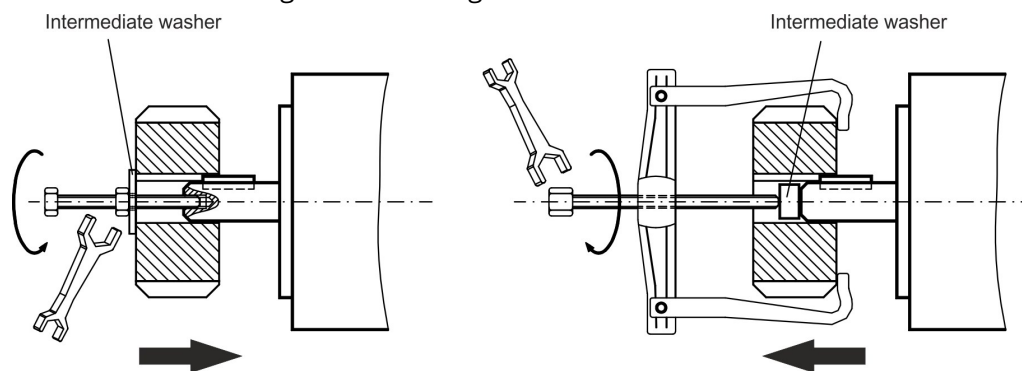

- Wherever possible, use only backlash-free, frictionally-locking collets or couplings. Ensure correct alignment of the couplings. A displacement will cause unacceptable vibration and the destruction of the bearings and the coupling.
- In all cases, do not create a mechanically constrained motor shaft mounting by using a rigid coupling with additional external bearings (e.g. in a gearbox).
- Take note of the no. of motor poles and the no. of resolver poles (if applicable), and ensure that the correct setting is made in the servo amplifier which is used. An incorrect setting can lead to the destruction of the motor, especially with small motors.
- Avoid axial loads on the motor shaft, as far as possible. Axial loading significantly shortens the life of the motor.
- Check the compliance to the permitted radial and axial forces F_R and F_A . When you use a toothed belt drive, the minimal permitted diameter of the pinion e.g. follows from the equation: $d_{\min} \geq (M_0/F_R) \cdot 2$

1.6 Electrical Installation

NOTE

Pinout for the connector can be found in chapter "Connector Pinout" from [Connector Pinout](#). Pinout of the servo amplifier's end can be found in the instructions manual of the servo amplifier.

1.6.1 Important notes

NOTE

Only staff qualified and trained in electrical engineering are allowed to wire up the motor.



DANGER

Always make sure that the motors are de-energized during assembly and wiring, i.e. no voltage may be switched on for any piece of equipment which is to be connected.



There is a risk of death or severe injury from touching exposed contacts. Ensure that the switch cabinet remains turned off (barrier, warning signs etc.). The individual voltages will only be turned on again during setup.

Never undo the electrical connections to the motor while it is energized. Risk of electric shock! In unfavorable circumstances, electric arcs can arise causing harm to people and damaging contacts.

A dangerous voltage, resulting from residual charge, can be still present on the capacitors up to 10 minutes after switch-off of the mains supply. Even when the motor is not rotating, control and power leads may be live.

Measure the DC-link voltage and wait until it has fallen below 60V.

NOTE

The ground symbol , which you will find in the wiring diagrams, indicates that you must provide an electrical connection, with as large a surface area as possible, between the unit indicated and the mounting plate in the switch cabinet. This connection is to suppress HF interference and must not be confused with the PE (protective earth) symbol  (protective measure to EN 60204).

To wire up the motor, use the wiring diagrams in the Installation and Setup Instructions of the servo amplifier which is used.

1.6.2 Guide for electrical installation

- Check that the servo amplifier and motor match each other. Compare the rated voltage and rated current of the unit. Carry out the wiring according to the wiring diagram in the instructions manual of the servo amplifier. The connections to the motor are shown in chapter "Connector Pinout" from [Connector Pinout](#).
- Install all cables carrying a heavy current with an adequate cross-section, as per EN 60204. The recommended cross-section can be found in the Technical data.

NOTE

In case of long motor cables (>25m) and dependent on the type of the used servo amplifier a motor choke must be switched into the motor cable (see instructions manual of the servo amplifier and accessory manual).

- Ensure that there is proper earthing of the servo amplifier and the motor. Use correct earthing and EMC-shielding according to the instructions manual of the servo amplifier which is used. Earth the mounting plate and motor casing.
- If a motor power cable is used which includes integral brake control leads, then these brake control leads must be shielded. The shielding must be connected at both ends (see instructions manual of the servo amplifier).
- Cabling:
 - Route power cables as separately as possible from control cables
 - Connect the feedback device.
 - Connect the motor cables, install motor chokes (if applicable) close to the amplifier
 - Connect shields to shielding terminals or EMC connectors at both ends
 - Connect the holding brake, if used
 - Connect shielding at both ends.
- Connect up all shielding via a wide surface-area contact (low impedance) and metallized connector housings or EMC-cable glands.
- Requirements to cable material:

Capacitance
 Motor cable: less than 150 pF/m
 Feedback cable: less than 120 pF/m

1.6.3 Connection of the motors with preassembled cables

- Carry out the wiring in accordance with the valid standards and regulations.
- Only use Kollmorgen preassembled shielded cables for the feedback and power connections.
- Incorrectly installed shielding leads to EMC interference and has an adverse effect on system function.
- The maximum cable length is defined in the instructions manual of the used servo amplifier.

NOTE

For a detailed description of configured cables, please refer to the regional accessories manual.

1.7 Setup

1.7.1 Important notes

NOTE

Only specialist personnel with extensive knowledge in the areas of electrical engineering / drive technology are allowed to commission the drive unit of servo amplifier and motor.

**DANGER**

Deadly voltages can occur, up to 900 V. Risk of electric shock! Check that all live connection points are safe against accidental contact.

Never undo the electrical connections to the motor when it is live. Risk of electric shock! The residual charge in the capacitors of the drive can produce dangerous voltages up to 10 minutes after the mains supply has been switched off.

Even when the motor is not rotating, control and power leads may be live. Measure the DC-link voltage and wait until it has fallen below 60 V.

**CAUTION**

The surface temperature of the motor can exceed 100°C in operation. Danger of light burns! Check (measure) the temperature of the motor. Wait until the motor has cooled down below 40°C before touching it.

**CAUTION**

The drive performing unplanned movements during commissioning cannot be ruled out.

Make sure that, even if the drive starts to move unintentionally, no danger can result for personnel or machinery.

The measures you must take in this regard for your task are based on the risk assessment of the application.

1.7.2 Guide for setup

The procedure for setup is described as an example. A different method may be appropriate or necessary, depending on the application of the equipment.

1. Check the assembly and orientation of the motor.
2. Check the drive components (clutch, gear unit, belt pulley) for the correct seating and setting (observe the permissible radial and axial forces).
3. Check the wiring and connections to the motor and the servo amplifier. Check that the earthing is correct.
4. Test the function of the holding brake, if used. (apply 24 V, brake must be released).
5. Check whether the rotor of the motor revolves freely (release the brake, if necessary). Listen for grinding noises.
6. Check that all the required measures against accidental contact with live and moving parts have been carried out.
7. Carry out any further tests which are specifically required for your system.
8. Now commission the drive according to the setup instructions for the servo amplifier.
9. In multi-axis systems, individually commission each drive unit (amplifier and motor).

1.7.3 Trouble Shooting

The following table is to be seen as a "First Aid" box. There can be a large number of different reasons for a fault, depending on the particular conditions in your system. The fault causes described below are mostly those which directly influence the motor. Peculiarities which show up in the control loop behaviour can usually be traced back to an error in the parameterization of the servo amplifier. The documentation for the servo amplifier and the setup software provides information on these matters.

For multi-axis systems there may be further hidden reasons for faults.

Fault	Possible cause	Measures to remove the cause of the fault
Motor doesn't rotate	<ul style="list-style-type: none"> — Servoamplifier not enabled — Break in setpoint lead — Motor phases in wrong sequence — Brake not released — Drive is mechanically blocked 	<ul style="list-style-type: none"> — Supply ENABLE signal — Check setpoint lead — Correct the phase sequence — Check brake controls — Check mechanism
Motor runs away	<ul style="list-style-type: none"> — Motor phases in wrong sequence 	<ul style="list-style-type: none"> — Correct the phase sequence
Motor oscillates	<ul style="list-style-type: none"> — Break in the shielding of the feedback cable — amplifier gain too high 	<ul style="list-style-type: none"> — Replace feedback cable — use motor default values
Error message: brake	<ul style="list-style-type: none"> — Short-circuit in the supply voltage lead to the motor holding brake — Faulty motor holding brake 	<ul style="list-style-type: none"> — Remove the short-circuit — Replace motor
Error message: output stage fault	<ul style="list-style-type: none"> — Motor cable has short-circuit or earth short — Motor has short-circuit or earth short 	<ul style="list-style-type: none"> — Replace cable — Replace motor
Error message: feedback	<ul style="list-style-type: none"> — Feedback connector is not properly plugged in — Break in feedback cable, cable crushed or similar 	<ul style="list-style-type: none"> — Check connector — Check cables
Error message: motor temperature	<ul style="list-style-type: none"> — Motor thermosensor has switched — Loose feedback connector or break in feedback cable 	<ul style="list-style-type: none"> — Wait until the motor has cooled down. Then investigate why the motor becomes so hot. — Check connector, replace feedback cable if necessary
Brake does not grip	<ul style="list-style-type: none"> — Required holding torque too high — Brake faulty — Motor shaft axially overloaded 	<ul style="list-style-type: none"> — Check the dimensioning — Replace motor — Check the axial load, reduce it. Replace motor, since the bearings have been damaged

1.8 Definition of Terms for Technical Data

NOTE

Technical data for every motor type can be found in chapter "Technical Data" [Technical Data](#).

All data valid for 40°C environmental temperature and 100K overtemperature of the winding. Determination of nominal data with constant temperature of adapter flange of 65°C. The data can have a tolerance of +/- 10%.

Standstill torque M_0 [Nm]

The standstill torque can be maintained indefinitely at a speed $0 < n < 100$ rpm and rated ambient conditions.

Rated torque M_n [Nm]

The rated torque is produced when the motor is drawing the rated current at the rated speed. The rated torque can be produced indefinitely at the rated speed in continuous operation (S1).

Standstill current I_{0rms} [A]

The standstill current is the effective sinusoidal current which the motor draws at $0 < n < 100$ rpm to produce the standstill torque.

Peak current (pulse current) I_{0max} [A]

The peak current (effective sinusoidal value) is several times the rated current depending on the motor winding. The actual value is determined by the peak current of the drive which is used.

Torque constant K_{Trms} [Nm/A]

The torque constant defines how much torque in Nm is produced by the motor with 1A r.m.s. current. The relationship is $M = I \times K_T$.

Voltage constant K_{Erms} [mV/min-1]

The voltage constant defines the induced motor EMF, as an effective sinusoidal value between two terminals, per 1000 rpm. Measured at 25°C.

Rotor moment of inertia J [kgcm²]

The constant J is a measure of the acceleration capability of the motor. For instance, at I_0 the acceleration time t_b from 0 to 3000 rpm is given as:

$$t_b [s] = \frac{3000 \cdot 2\pi}{M_0 \cdot 60s} \cdot \frac{m^2}{10^4 \cdot cm^2} \cdot J \quad \text{with } M_0 \text{ in Nm and } J \text{ in kgcm}^2$$

Thermal time constant t_{th} [min]

The constant t_{th} defines the time for the cold motor, under a load of I_0 , to heat up to an overtemperature of 0.63×105 Kelvin. This temperature rise happens in a much shorter time when the motor is loaded with the peak current.

Release delay time t_{BRH} [ms] / Engage delay time t_{BRL} [ms] of the brake

These constants define the response times of the holding brake when operated with the rated voltage from the servo amplifier.

U_N

Rated mains voltage

U_n

DC-Bus link voltage. $U_n = \sqrt{2} \cdot U_N$

2 Deutsch

2.1 Allgemeines	30
2.1.1 Zu diesem Handbuch	30
2.1.2 Verwendete Abkürzungen	30
2.1.3 Verwendete Symbole	30
2.2 sicherheit	31
2.2.1 Darauf sollten Sie achten	31
2.2.2 Bestimmungsgemäße Verwendung	33
2.2.3 Nicht bestimmungsgemäße Verwendung	33
2.2.4 Handhabung	34
2.3 Bauform	36
2.3.1 Lieferumfang	36
2.3.2 Typenschild	36
2.3.3 Beschreibung der Modellnummer AKM2G	37
2.4 Technische Beschreibung	43
2.4.1 Allgemeine technische Daten	43
2.4.2 Standardmerkmale	43
2.4.3 Anschlusstechnik	48
2.4.4 Haltebremse	49
2.5 Mechanische Installation	50
2.5.1 Wichtige Hinweise	50
2.6 Elektrische Installation	51
2.6.1 Wichtige Hinweise	51
2.6.2 Leitfaden für die elektrische Installation	52
2.6.3 Anschluss der Motoren mit vorkonfektionierten Leitungen	52
2.7 Inbetriebnahme	53
2.7.1 Wichtige Hinweise	53
2.7.2 Leitfaden für die Inbetriebnahme	54
2.7.3 Beseitigen von Störungen	55
2.8 Begriffsdefinitionen für technische Daten	56

2.1 Allgemeines

2.1.1 Zu diesem Handbuch

Dieses Handbuch beschreibt die AKM@2G Synchron-Servomotoren (Standard-/Niederspannungsausführung). Die Motoren werden in Antriebssystemen zusammen mit Kollmorgen Servoverstärkern betrieben. Beachten Sie daher die gesamte Dokumentation des Systems, bestehend aus:

- Betriebsanleitung des Servoverstärkers
- Manuelle Buskommunikation (z. B. CANopen oder EtherCAT)
- Online-Hilfe der Inbetriebnahmesoftware des Servoverstärkers
- Regionales Zubehörhandbuch
- Technische Beschreibung AKM2G der Motorserie







Weitere Informationen finden Sie im Kollmorgen Developer Network unter kdn.kollmorgen.com geliefert wurden.

2.1.2 Verwendete Abkürzungen

NOTE

Die Abkürzungen für die technischen Daten finden Sie im Kapitel „Begriffsdefinitionen“. → p. 56 geliefert wurden.
In diesem Dokument bedeutet die Symbolik (→ # 53): siehe Seite 53.

2.1.3 Verwendete Symbole

Zeichen	Bedeutung
 GEFAHR	Weist auf eine gefährliche Situation hin, die, wenn sie nicht vermieden wird, zum Tode oder zu schweren, irreversiblen Verletzungen führen wird.
 WARNUNG	Weist auf eine gefährliche Situation hin, die, wenn sie nicht vermieden wird, zum Tode oder zu schweren, irreversiblen Verletzungen führen kann.
 ACHTUNG	Weist auf eine gefährliche Situation hin, die, wenn sie nicht vermieden wird, zu leichten Verletzungen führen kann.
NOTICE	Weist auf eine Situation hin, die, wenn sie nicht vermieden wird, zu Beschädigung von Sachen führen kann.
NOTE	Dieses Symbol weist auf wichtige Informationen hin.
	Warnung vor einer Gefahr (allgemein). Die Art der Gefahr wird durch den Text neben dem Symbol angegeben.
	Warnung vor Gefahren durch Elektrizität und deren Auswirkungen.
	Warnung vor Gefahr durch heiße Oberflächen.
	Warnung vor hängenden oder schwebenden Lasten.

2.2 sicherheit

Dieser Abschnitt hilft Ihnen, Gefahren für Personen und Sachwerte zu erkennen und zu vermeiden.

2.2.1 Darauf sollten Sie achten

Fachpersonal ist erforderlich!

Nur qualifiziertes Personal darf Arbeiten wie Transport, Montage, Inbetriebnahme und Wartung ausführen. Qualifiziertes Fachpersonal sind Personen, die mit dem Transport, der Installation, der Montage, der Inbetriebnahme und dem Betrieb von Motoren vertraut sind und ihre jeweiligen Mindestqualifikationen einbringen:

- Transport: nur durch Personal, das für den Umgang mit elektrostatisch empfindlichen Bauteilen geschult ist.
- Mechanische Installation: nur durch Fachleute mit maschinenbautechnischer Ausbildung.
- Elektrische Installation: nur durch Fachleute mit elektrotechnischer Ausbildung.
- Inbetriebnahme: nur durch Fachleute mit weitreichenden Kenntnissen in den Bereichen Elektrotechnik/Antriebstechnik.

Das Fachpersonal muss die Normen IEC 60364/IEC 60664 und die nationalen Unfallverhütungsvorschriften kennen und beachten.

Lesen Sie die Dokumentation sorgfältig durch!

Lesen Sie vor der Installation und Inbetriebnahme die vorliegende Dokumentation. Unsachgemäße Handhabung des Motors kann zu Personen- oder Sachschäden führen. Der Betreiber muss daher sicherstellen, dass alle mit Arbeiten am Motor betrauten Personen das Handbuch gelesen und verstanden haben und dass die Sicherheitshinweise in diesem Handbuch beachtet werden.

Beachten Sie die technischen Daten!

Halten Sie die technischen Daten und die Angaben zu den Anschlussbedingungen (Typenschild und Dokumentation) ein. Werden zulässige Spannungs- oder Stromwerte überschritten, können die Motoren z. B. durch Überhitzung beschädigt werden.

Führen Sie eine Risikobeurteilung durch!

Der Maschinenhersteller muss eine Risikobeurteilung für die Maschine erstellen und geeignete Maßnahmen dafür treffen, dass unvorhergesehene Bewegungen nicht zu Sach- oder Personenschäden führen können. Aus der Risikobeurteilung können sich darüber hinaus zusätzliche Anforderungen an das Fachpersonal ergeben.

Sorgen Sie für einen sicheren Transport!

Heben und Bewegen Sie Motoren mit mehr als 20 kg Gewicht (AKM2G7) nur mit Hebezeugen. Das Anheben ohne Hilfsmittel kann zu Rückenverletzungen führen. Beachten Sie stets die Hinweise auf [Transport](#)

Sichern Sie die Passfeder!

Entfernen Sie eine eventuell vorhandene Passfeder von der Welle, bevor Sie den Motor ohne angekoppelte Last laufen lassen, um ein gefährliches Herausschleudern der Passfeder durch Fliehkräfte zu vermeiden. Im Auslieferungszustand ist die Passfeder mit einer Kunststoffkappe abgedeckt.

Heiße Oberfläche!



Die Oberflächen der Motoren können im Betrieb je nach Schutzart sehr heiß werden. Gefahr von leichten Verbrennungen! Die Oberflächentemperatur kann 100 °C überschreiten. Messen Sie die Temperatur und warten Sie, bis der Motor unter 40 °C abgekühlt ist, bevor Sie ihn berühren.

Erdung! Hochspannungen!



Es ist unbedingt darauf zu achten, dass das Motorgehäuse sicher mit der PE-Sammelschiene im Schaltschrank verbunden und somit geerdet ist. Es besteht die Gefahr eines elektrischen Schlages. Ohne niederohmige Erdung kann kein Schutz für Personen gewährleistet werden und es besteht Lebensgefahr durch Stromschlag.

Der Verzicht auf optische Anzeigen garantiert keine Spannungsfreiheit. Leistungsanschlüsse können Spannung führen, auch wenn sich die Motorwelle nicht dreht.

Ziehen Sie während des Betriebs keine Stecker ab. Es besteht die Gefahr von Tod oder schweren Verletzungen durch Berühren freiliegender Kontakte.

Leistungsanschlüsse können auch bei nicht drehendem Motor unter Spannung stehen. Dies kann zu Überschlägen und somit zu Personenschäden und Beschädigungen der Kontakte führen.

Warten Sie nach dem Trennen des Servoverstärkers von der Versorgungsspannung einige Minuten, bevor Sie spannungsführende Komponenten (z. B. Kontakte, Schraubverbindungen) berühren oder Anschlüsse öffnen.

Die Kondensatoren im Servoverstärker können auch einige Minuten nach dem Abschalten der Versorgungsspannungen noch eine gefährliche Spannung führen. Messen Sie zur Sicherheit die Zwischenkreisspannung und warten Sie, bis die Spannung unter 60 V abgesunken ist.

Sichern Sie hängende Lasten!



Die eingebauten Haltebremsen gewährleisten keine Funktionssicherheit! Der Anwender muss im Fall von hängenden Lasten (vertikale Achsen) lokale Sicherheitsstandards beachten und zur Gewährleistung der Arbeitssicherheit gegebenenfalls zusätzliche Sicherheitsmaßnahmen ergreifen.

2.2.2 Bestimmungsgemäße Verwendung

- Die AKM2G Serie der Synchron-Servomotoren sind speziell als Antriebe für Industrieroboter, Werkzeugmaschinen, Textil- und Verpackungsmaschinen und ähnliche Anwendungen mit hohen Ansprüchen an die Dynamik konzipiert.
- Der Anwender darf die Motoren nur unter den in dieser Dokumentation definierten Umgebungsbedingungen betreiben.
- Die AKM2G Motorserie ist **ausschließlich** dazu bestimmt, von digitalen Servoverstärkern drehzahl- und/oder drehmomentgeregelt angesteuert zu werden.
- Die Motoren werden als Bauteile in elektrische Anlagen oder Maschinen eingebaut und dürfen nur als integrierte Bauteile der Anlage in Betrieb genommen werden.
- Der in den Motorwicklungen eingebaute Thermosensor muss überwacht und entsprechend ausgewertet werden.
- Die Haltebremsen sind als Stillstandsbremsen ausgelegt und für betriebsmäßige Abbremsvorgänge ungeeignet.
- Die Konformität des Servosystems zu den in der CE-Konformitätserklärung genannten Normen [Approvals](#) ist nur gewährleistet, wenn die verwendeten Komponenten (Servoverstärker, Motor, Kabel usw.) von Kollmorgengeliefert wurden.

2.2.3 Nicht bestimmungsgemäße Verwendung

- Die Verwendung der **standardmäßigen** Motoren in folgenden Umgebungen ist verboten:
 - direkt am Stromnetz,
 - in explosionsgefährdeten Bereichen,
 - bei Kontakt mit Lebensmitteln und Getränken,
 - in Umgebungen mit ätzenden und/oder elektrisch leitenden Säuren, Laugen, Ölen, Dämpfen, Stäuben.
- Die Inbetriebnahme des Motors ist untersagt, wenn die Maschine, in die er eingebaut wurde,
 - nicht den Bestimmungen der EG-Maschinenrichtlinie entspricht,
 - nicht die Bestimmung der EMV-Richtlinie erfüllt,
 - nicht die Bestimmung der Niederspannungs-Richtlinie erfüllt.
- Die eingebauten Haltebremsen dürfen ohne weitere Ausstattung nicht zur Gewährleistung der Funktionssicherheit verwendet werden.

2.2.4 Handhabung

2.2.4.1 Transport

- Klimaklasse 2K3 nach EN 61800-2 und IEC 60721-3-2
- Temperatur: -25...+70 °C, max. 20 K/Stunde schwankend
- Feuchtigkeit: relative Luftfeuchtigkeit 5–95 %, nicht kondensierend
- Nur durch qualifiziertes Personal in der recycelbaren Originalverpackung des Herstellers
- Vermeiden Sie Stöße, insbesondere auf das Wellenende
- Überprüfen Sie bei beschädigter Verpackung den Motor auf sichtbare Schäden. Informieren Sie den Frachtführer und gegebenenfalls den Hersteller.

Transport von Motoren mit einem Gewicht von über 20 kg

Für den sicheren Transport von 7 Motoren (> 20 kg) AKM2G müssen Hebeösen verwendet werden. Beachten Sie die in der Verpackung des Motors enthaltene Transporthinweise.

Zum Bewegen der Motoren empfehlen wir das Transportwerkzeug ZPZM 120/292.

Die Aufhängung ZPMZ 120/292 besteht aus einem am Kranhaken aufgehängten Träger und zwei doppelsträngigen Kettenaufhängern.



GEFAHR

Hängende Last. Lebensgefahr bei herunterfallender Last. Stellen Sie sich niemals unter die Last, während der Motor angehoben ist.

- Die Befestigungsschrauben der Hebeösen müssen vollständig eingeschraubt sein.
- Die Hebeösen müssen gleichmäßig und flach auf der Auflagefläche positioniert werden.
- Überprüfen Sie die Hebeösen vor Gebrauch auf festen Sitz und offensichtliche Beschädigungen (Korrosion, Verformung).
- Hebeösen mit Verformungen dürfen nicht verwendet werden.

B1/ 4 x Lifting Bolt Plus Lifting Beam

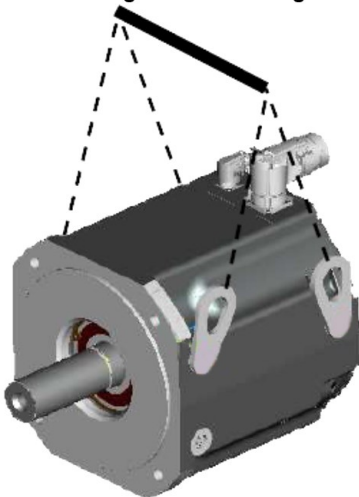

B2/ 2 x Lifting Bolt Plus Lifting Beam

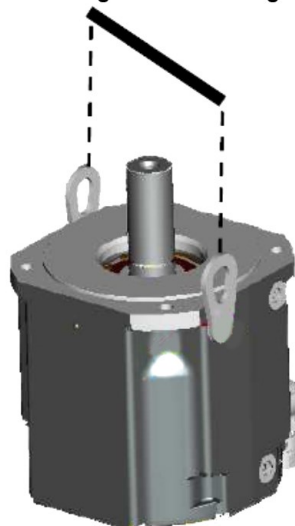

B3/ 2 x Lifting Bolt Plus Lifting Beam

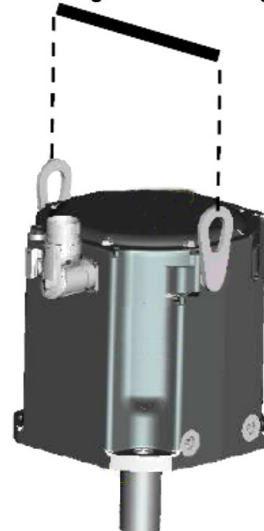

2.2.4.2 Verpackung

- Kartonverpackung mit Instapak® Schaumkissen.
- Sie können die Kunststoffteile an den Lieferanten zurückgeben (siehe „Entsorgung“).

Motortyp	Verpackung	Max. Stapelhöhe
AKM2G2	Karton	10
AKM2G3	Karton	6
AKM2G4	Karton	6
AKM2G5	Karton	5
AKM2G6	Karton	1
AKM2G7	Karton	1

2.2.4.3 Lagerung

- Klimaklasse 1K4 nach IEC 60721-3-1 und EN 61800-2
- Lagertemperatur: - 25...+55 °C, max. 20 K/Stunde schwankend.
- Feuchtigkeit: relative Luftfeuchtigkeit 5–95 %, nicht kondensierend
- Nur in der recycelbaren Originalverpackung des Herstellers lagern
- Max. Stapelhöhe: siehe Tabelle im Abschnitt „Verpackung“
- Lagerdauer: ohne Einschränkung

2.2.4.4 Wartung/Reinigung

- Wartung und Reinigung nur durch qualifiziertes Personal
- Die Kugellager sollten nach 20.000 Betriebsstunden unter Nennbedingungen erneuert werden (vom Hersteller).
- Prüfen Sie den Motor alle 2.500 Betriebsstunden bzw. einmal jährlich auf Lagergeräusche. Wenn Sie Geräusche feststellen, darf der Motor nicht weiterbetrieben werden – die Lager müssen erneuert werden (vom Hersteller).
- Das Öffnen des Motors führt zum Erlöschen der Garantie.
- Wenn das Gehäuse verschmutzt ist, das Gehäuse mit Isopropanol o.ä. reinigen, nicht eintauchen oder besprühen.

2.2.4.5 Reparatur/Entsorgung

Die Reparatur des Motors muss vom Hersteller durchgeführt werden. Das Öffnen des Motors führt zum Erlöschen der Garantie. Gemäß der WEEE-Richtlinie 2012/19/EU nehmen wir Altgeräte und Zubehör zur fachgerechten Entsorgung zurück, wenn die Transportkosten vom Absender übernommen werden. Schicken Sie den Motor an:

Kollmorgen s.r.o.

z. Hd. von: Reparaturabteilung

Evropska 864

664 42 Modrice / Tschechische Republik

E-Mail: brno_customer_repairs@kollmorgen.com

Tel.: +420533314455

2.3 Bauform

2.3.1 Lieferumfang

- Motor der AKM2G Serie
- Produkthandbuch (mehrsprachig) gedruckt, eines pro Lieferung

2.3.2 Typenschild

Bei Standardmotoren ist das Typenschild gehäuseseitig verklebt.

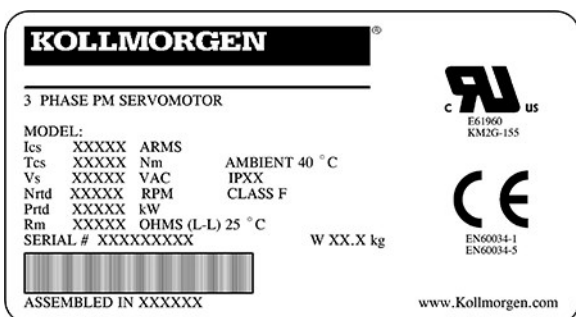
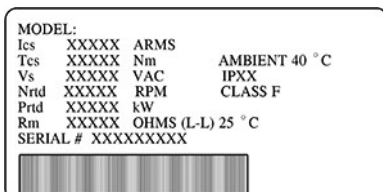

Legende	Beschreibung
MODEL	Motortyp
Ics	Stillstandsstrom
Tcs	Stillstandsrehnmoment
Vs	U_N UN (Spannung)
Nrtd	nn (Nenndrehzahl bei Un)
Prtd	Pn (Nennleistung)
Rm	R25 (Wicklungswiderstand bei 25°)
SERIAL	Seriennummer
AMBIENT	maximale Umgebungstemperatur
W	Motorgewicht in kg
IPXX	Schutzart
KLASSE F	Nennisolierung

Das Herstellungsjahr ist in der Seriennummer kodiert: die ersten beiden Ziffern der Seriennummer sind das Herstellungsjahr, z. B. „17“ bezeichnet das Jahr 2017.

2.3.3 Beschreibung der Modellnummer AKM2G

2.3.3.1 Typenschlüssel

Verwenden Sie den Typenschlüssel nur zur Produktidentifizierung und nicht für den Bestellvorgang, da nicht alle theoretischen Kombinationen von Merkmalen möglich sind.

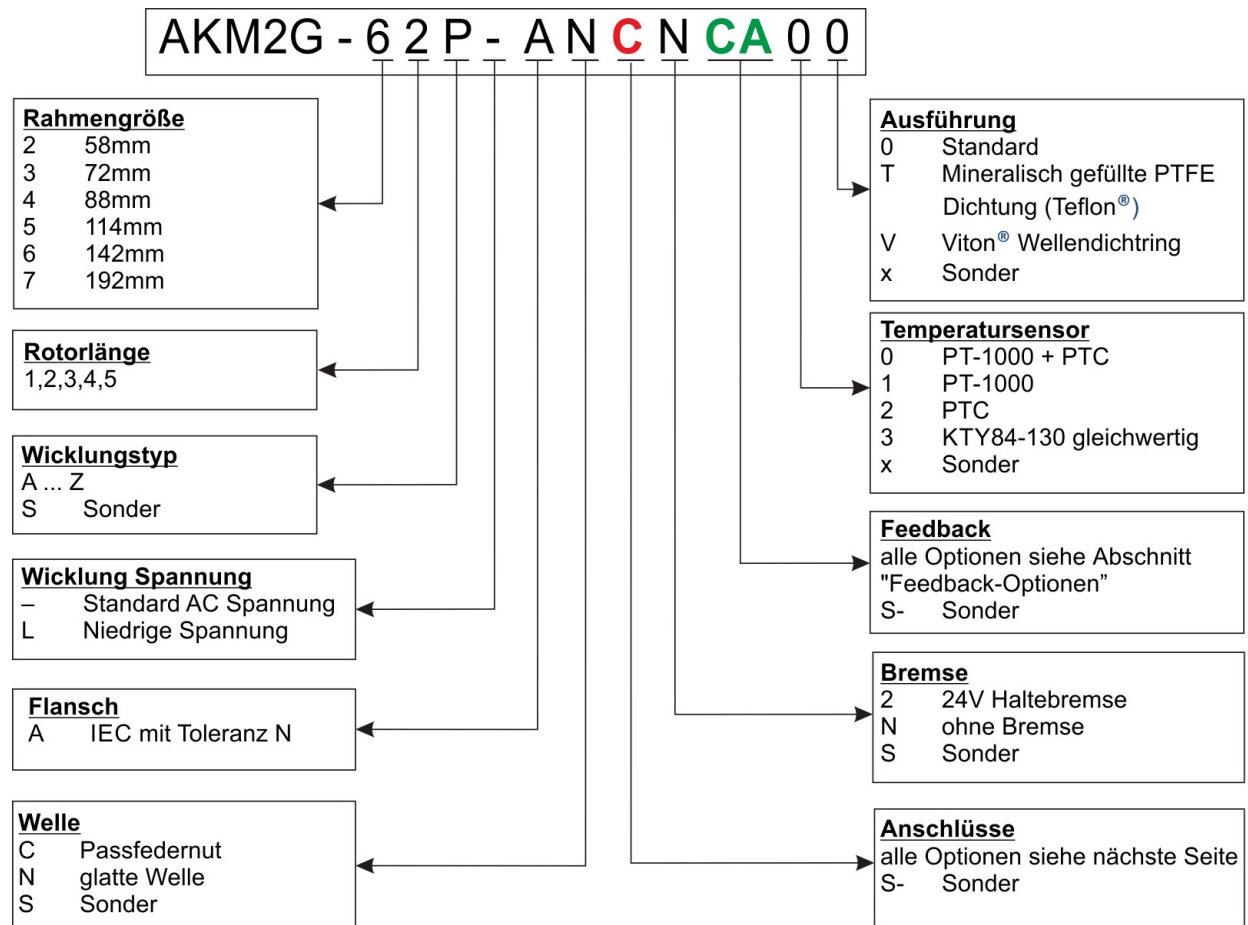

2.3.3.2 Anschlussoptionen (C)

Die Belegung der Steckeroptionen ist im Kapitel „Steckerbelegung“ auf [Connector Pinout](#) geliefert wurden.

2.3.3.3.1 Beschreibung des Steckers

Stecker	Verwendung*	Kontakte - Pins	max. strom [A]	max. Quer- schnitt [mm ²]	Schutzart	Kabel Stromversorgung Leiter- größe (mm ²)	Empfohlener Gegen- stecker
		Leistung/ Signal	Leistung/ Signal	Leistung/ Signal			
M23 SpeedTec Winkel- steckverbinder (Größe 1)	Leistung und Bremsen	4/5	20/10	4/1,5	IP65	1,5	BSTA-082-FR- 46-58-0100-000
						2,5	BSTA-082-FR- 46-58-0100-000
						4,0	BSTA-082-FR- 32-59-0100-000
	Resolver	-/12	-/10	-/0,5	IP65	-	ASTA-013-FR- 01-62-0100-000
	Encoder	-/17	-/10	-/0,5	IP65	-	ASTA-014-FR- 01-61-0100-000
	Hybrid (SFD3)	4/5	20/10	4/1,5	IP65	1,5	BSTA-082-FR- 46-58-0100-000
						2,5	BSTA-082-FR- 46-58-0100-000
						4,0	BSTA-082-FR- 32-58-0100-000
	Hybrid (DSL)	4/5	20/10	4/1,5	IP65	1,5	H51A-425-FR- 14-58-0100-000 + 40.A711.00
						2,5	H51A-425-FR- 14-58-0100-000 + 40.A711.00
						4,0	H51A-425-FR- 15-59-0100-000 + 40.A711.00
	Hybrid (EnDat)	4/5	20/10	4/1,5	IP65	1,5	H51A-405-FR- 14-59-0100-000 + 40.A702.00
						4,0	H51A-405-FR- 15-59-0100-000 + 40.A702.00

Stecker	Verwendung*	Kontakte - Pins	max. strom [A]	max. Quer- schnitt [mm ²]	Schutzart	Kabel Stromversorgung Leiter- größe (mm ²)	Empfohlener Gegen- stecker
		Leistung/ Signal	Leistung/ Signal	Leistung/ Signal			
M40 (Größe 1,5)	Leistung und Bremsen	4/5	75/30	16/4	IP65	4,0	CSTA-265-FR- 06-26-0020-000
						6,0	CSTA-265-FR- 06-25-0020-000
						10,0	CSTA-265-FR- 06-25-0020-000
	Hybrid (SFD3)	4/5	75/30	16/4	IP65	4,0	CSTA-265-FR- 06-26-0020-000
						6,0	CSTA-265-FR- 06-25-0020-000
						10,0	CSTA-265-FR- 06-25-0020-000
	Hybrid (DSL)	4/5	75/30	16/4	IP65	4,0	H81A-501-FR- 03-44-0100-000 + 40.A711.00
						6,0	H81A-501-FR- 03-45-0100-000 + 40.A711.00
	y-tec	Leistung und Bremsen	4/5	14/3,6	1,5/0,75	IP65	1,5
Rückführung		-/12	-/5	-/0,75	IP65		ESTB-002-FR- 02-32-0001-000

Hybrid (SFD3) bedeutet Leistung und SFD3-Rückführung (plus Bremsen) am gleichen Stecker und in einem Kabel.

Hybrid (DSL) bedeutet Leistung und DSL-Rückführung (plus Bremsen) am gleichen Stecker und in einem Kabel.

Hybrid (EnDat) bedeutet Leistung und EnDat-Rückführung (plus Bremsen) am gleichen Stecker und in einem Kabel.

2.3.3.4.2 Steckerbezeichnung – Motor

Modellbezeichnung	Anschlusstechnik	Verwendbar mit	Position des Anschlusses
C	2 Speedtec M23	AKM2G3- AKM2G7 ≤ 20 A	Abgewinkelt, drehbar, motormontiert
D*	1 Hybrid M23	AKM2G2- AKM2G7 ≤ 20 A	Abgewinkelt, drehbar, motormontiert
G	2 Speedtec M23	AKM2G3- AKM2G7 ≤ 20 A	Gerade, motormontiert
H	1 M40 Leistung, 1 M23 Rückführung	AKM2G7 > 20 A	Abgewinkelt, drehbar, motormontiert
J*	1 Hybrid-Stecker M40	AKM2G7 > 20 A	Abgewinkelt, drehbar, motormontiert
Y	1 y-tec-Stecker	AKM2G2	Drehbar, motormontiert

* Hybrid-Stecker nur gültig für SFD3, DSL und EnDat.

2.3.3.5 Rückführungsoptionen (CA)

Die Motorlänge ist abhängig von der eingebauten Rückführeinheiten, siehe Maßbilder auf [Dimension drawings](#) geliefert wurden.

Eine Nachrüstung ist nicht möglich. Die Belegung der Steckeroptionen finden Sie auf [Connector Pinout](#) geliefert wurden.

2.3.3.6.1 Beschreibung der Rückführung

Cod e	Beschreibung	Motor-ID Support 3	Genauigkeit 1,2 (Bogen-sekunden)	RMS-Störung 1 (Bogen-sekunden)	Bemerkunge n	Auflösun g	Absolut Umdrehunge n	Kompatibl e Antriebe	Funktion s-sicherheit Support 4
CA	SFD3	Ja	±585"	±9,9"	Induktiv	24 Bit	1	AKD-Baureihe	Nein
GU	Hiperface DSL	Ja	±240"	±20"	Kapazitiv	17 Bit	4096	AKD-Baureihe	bis SIL 2 7,9
LD 5	EnDat 2.2	Ja	±120"	Siehe Hinweis 6 unten	Induktiv	19 Bit	4096	AKD-Baureihe	bis SIL310
			±65"						
R-	Resolver	Nein	±540"	Entfällt	Induktiv	24 Bit für AKD	1	Alle	Nein
2-8	Kommutierende r Encoder	Nein	+/-218,2"	Entfällt	Optisch	12 Bit	keine	AKD-Baureihe	

- AKD Servoverstärker haben eine Resolver-Messgenauigkeit von ±45" bei einer Antrieb-mit-Motor-Genauigkeit von ±585" und einem eff. Rauschen von ±9,9".
- Die Genauigkeit bezieht sich auf die Gesamt-Systemgenauigkeit nach dem Einbau in den Motor. Das Rauschen bezieht sich auf das effektive Positionsrauschen im Stillstand.
- Motor-ID-Unterstützung bedeutet, dass elektronische Motortypenschilddaten vorhanden sind, die eine Plug-and-Play-Inbetriebnahme ermöglichen.
- SIL-Einstufung des Geräts wie vom Hersteller des Rückmelders geliefert. Der Kunde ist für die Bewertung der funktionalen Sicherheit der Maschine verantwortlich.
- Für Motoren mit EnDat Rückführung ist die Beschleunigung des Motors auf $\leq 1 \cdot 10$ begrenzt. 5 rad/s² geliefert wurden. Der verbundene Servoverstärker kann diesen Wert weiter einschränken.
- Diese Angaben waren zum Zeitpunkt der Drucklegung nicht verfügbar. Bitte wenden Sie sich Kollmorgen wegen aktueller Daten an den Kundendienst.
- Für Motoren mit der Seriennummer 1935100001 oder später.
- Nur für Niederspannungsmotoren AKM2G3 und höher verfügbar.
- Spezifische Informationen zu den Spezifikationen der funktionalen Sicherheit dieser Rückführung finden Sie auf der Website des Herstellers (Link unten). Der Abschnitt „Sicherheitsrelevante Parameter“ enthält spezifische Informationen über die Sicherheitseigenschaften des Produkts. Andere Abschnitte enthalten zusätzliche Einzelheiten.
www.sick.com/us/en/motor-feedback-systems/motor-feedback-systems-rotary-hiperface-dsl/eeseem37/eem37-2kf0a017a/p/p486170
Website-Informationen und Links sind zum Zeitpunkt der Herausgabe dieses Handbuchs auf dem aktuellen Stand. Alternativ können Sie auf der Website nach dem Produkt #1067125 suchen.
- Spezifische Informationen zu den Spezifikationen der funktionalen Sicherheit dieser Rückführung finden Sie auf der unten aufgeführten Website des Herstellers.
www.heidenhain.com/en_US/products/rotary-encoders/without-integral-bearing/
Wählen Sie auf dieser Seite den korrekten Dokumentlink für die Rückführung, die in der AKM2G geliefert wurden.

AKM2G Größe	Modellnummer des Herstellers	Allgemeine Sicherheitsinformationen	Modellspezifische Informationen
Baugröße 2-4	EQI 1131	Seiten 28-29	Seiten 72-75
Baugröße 5-7	EQI 1331	Seiten 28-29	Seiten 78-79

Website-Informationen und Links sind zum Zeitpunkt der Herausgabe dieses Handbuchs auf dem aktuellen Stand. Alternativ können Sie auf der Website nach der obigen Modellnummer suchen.

2.3.3.7.2 Die verfügbaren Steckeroptionen richten sich nach der Wahl der Rückführung.*SFD3*

Steckertyp	kompatibel AKM2Gx	Typ
D	AKM2G2-4	Größe 15
D	AKM2G5-7 ≤ 20 A	Größe 21
J	AKM2G7 > 20 A	Größe 21

Hiperface DSL

Steckertyp	kompatibel AKM2Gx	Typ
D	AKM2G2-7 ≤ 20 A	EEM37
J	AKM2G7 > 20 A	EEM37

EnDat 2.2

Steckertyp	kompatibel AKM2Gx	Typ
D	AKM2G2-4	EQI 1131
D	AKM2G5-7 ≤ 20 A	EQI 1331

Resolver

Steckertyp	kompatibel AKM2Gx	Typ
Y	AKM2G2	Größe 15
C/G	AKM2G3-4	Größe 15
C/G	AKM2G5-7 ≤ 20 A	Größe 21
H	AKM2G7 > 20 A	Größe 21

Kommutierender Encoder

Steckertyp	kompatibel AKM2Gx	Typ
C/G	AKM2G3-4	Größe 15

2.4 Technische Beschreibung

2.4.1 Allgemeine technische Daten

Umgebungstemperatur (bei Nennwerten)	5...+40 °C bei einer Aufstellhöhe bis 1000 m über NN Sprechen Sie bei Umgebungstemperaturen über 40 °C und bei gekapseltem Einbau der Motoren unbedingt mit unserer Applikationsabteilung.
Zulässige Luftfeuchtigkeit (bei Nennwerten)	95 % relative Feuchtigkeit, nicht kondensierend
Leistungsreduzierung (Ströme und Drehmomente)	1 %/K im Bereich 40 °C...50 °C bis 1000 m über NN. Bei Aufstellhöhen über 1000 m über NN und 40 °C 6 % bei bis zu 2000 m über NN 17 % bei bis zu 3000 m über NN 30 % bei bis zu 4000 m über NN 55 % bei bis zu 5000 m über NN Keine Leistungsreduzierung bei Aufstellhöhen über 1000 m über NN und Temperaturreduzierung um 10 K/1000 m
Lebensdauer Kugellager	≥ 20.000 Betriebsstunden

NOTE

Die technischen Daten für jeden Motortyp finden Sie im Kapitel „Technische Daten“ auf [Technical Data](#) aufgeführt.

2.4.2 Standardmerkmale

2.4.2.1 Ausführung

Die Grundbauform der AKM2G Motoren ist die Bauform IM B5 nach DIN EN 60034-7.

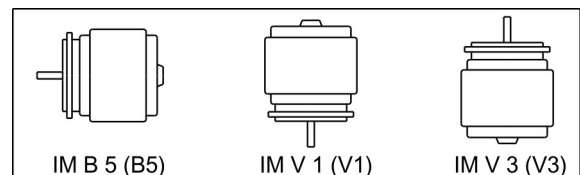

2.4.2.2 Flansch

IEC-Flanschgenauigkeit nach DIN 42955. Toleranzen des Wellenauslaufs und des Montageflansches bei rotierenden elektrischen Maschinen.

Code	Flansch
A	IEC mit Genauigkeit N, Passung AKM2G2-7: j6

2.4.2.3 Schutzart

Nach DIN EN 60529.

Standardmotor	Steckeroptionen	Wellendichtung	Schutzart
AKM2G2-AKM2G7	C, D, G, H, J, Y	ohne	IP54
AKM2G2-AKM2G7	C, D, G, H, J, Y	mit	IP65

2.4.2.4 Isolierstoffklasse

Die Motoren werden mit Isoliermaterial der Klasse F nach IEC 60085 (UL1446 Klasse F) geliefert.

2.4.2.5 Oberfläche

Die Motoren sind beschichtet mit: Epoxid Pulverbeschichtung in mattschwarz. Diese Beschichtung ist nicht beständig gegen Lösungsmittel (z. B. Trichlorethylen, Nitroverdünner o. ä.).

2.4.2.6 Wellenende, A-Seite

Die Kraftübertragung erfolgt über das zylindrische Wellenende A, Passung k6 nach EN 50347 mit Anzugsgewinde, jedoch **ohne Passfedernut**, geliefert wurden.

Die Motoren sind auch mit Passfedernut und eingesetzter Passfeder nach DIN 6885 erhältlich. Die Wuchtung der Welle mit Passfedernut erfolgt mit kurzer (halber) Passfeder.

Für die Lebensdauer der Lager sind 20.000 Betriebsstunden zugrunde gelegt.

Bestellcode	Wellenende	Verfügbar für
N	Glatte Welle	AKM2G 2-7
C	Passfedernut, geschlossen	AKM2G 2-7

Radialkraft

Treiben die Motoren über Ritzel oder Zahnriemen an, so treten hohe Radialkräfte auf. Die zulässigen Werte am Wellenende können den Diagrammen im Kapitel „Zeichnungen“ entnommen werden [Dimension drawings](#) geliefert wurden. Die Maximalwerte bei Nenndrehzahl finden Sie in den technischen Daten ab [Technical Data](#) geliefert wurden. Bei Kraftangriff an der Mitte des freien Wellenendes kann F_R 10 % größer sein, geliefert wurden.

Axialkraft

Bei der Montage von Ritzeln oder Riemenscheiben an die Achse und der Verwendung von z. B. Winkelgetrieben treten Axialkräfte auf. Die Maximalwerte bei Nenndrehzahl finden Sie in den technischen Daten.

Kupplung

Als ideale spielfreie Kupplungselemente haben sich doppelkonische Spannzangen, eventuell in Verbindung mit Metallbalg-Kupplungen, bewährt. Wellen-Mittelbohrung nach DIN 332, Form D.

2.4.2.7 Wellendichtung

Wird AKM2G an einen Maschinenflansch mit nicht abgedichtetem Wellenbereich angeschlossen, so sorgt die Wellendichtung (Option „T“ oder „V“) für die Abdichtung der Welle.

- Die Dichtungsoption „T“ besteht aus einer mineralverstärkten PTFE-Dichtung (Teflon®). Diese Dichtung ist selbstschmierend und wird für Anwendungen empfohlen, in denen eine regelmäßige Schmierung der Dichtung nicht möglich ist.
- Die Dichtungsoption „V“ besteht aus Viton® und wird für Anwendungen empfohlen, in denen die Wellendichtung regelmäßig geschmiert wird, wie z. B. geschmierte Getriebe.
- Die Wellendichtung gewährleistet die Schutzart IP65 für den Wellenbereich.
- Die Nennleistung wird nach einigen Stunden des Einlaufens der Wellendichtung erreicht. Ein spezieller Einlaufprozess ist nicht erforderlich.
- Ein leichtes „Ablösen“ des Wellendichtungsmaterials, insbesondere des Teflon®-Materials, ist üblich und beeinträchtigt die Funktion nicht.
- Die Wellendichtung ist mit einem Schmierfett vorgeschmiert.

2.4.2.8 Schutzeinrichtung

Die Standardausführung jedes Motors mit AC-Spannung ist mit einem galvanisch getrennten PT-1000+PTC ausgestattet. Die Niederspannungsversion jedes Motors ist mit einem elektrisch isolierten PT-1000 ausgestattet. Die Temperatursensoren bieten keinen Schutz gegen kurzzeitige, sehr hohe Überlastungen.

Der Motor kann wahlweise mit einem PT-1000 +PTC, PT-1000, PTC oder einem KTY 84-130 gleichwertigen Sensor geliefert werden (siehe [Thermische Geräteoptionen: Widerstand gegen Temperatur-Diagramme](#) Optionen 0, 1, 2 und 3).

Bei den digitalen Rückführsystemen SFD3 (CA), Hiperface DSL (GU), and EnDat 2.2 (LD) wird der Status des Temperatursensors digital übertragen und im Antrieb ausgewertet.

Der Sensor ist bei Verwendung unserer vorkonfektionierten Resolverleitung in das Überwachungssystem der digitalen Servoverstärker integriert.

2.4.2.9.1 Thermische Geräteoptionen: Widerstand gegen Temperatur-Diagramme

Die Kurven für thermische Geräteoptionen zeigen den äquivalenten Widerstand in Ohm für eine gegebene Temperatur der Motorwicklungen. Der mit dem Motor verwendete Antrieb muss das ausgewählte thermische Gerät unterstützen, um einen ordnungsgemäßen Betrieb zu gewährleisten.

Thermische Geräteoption 0

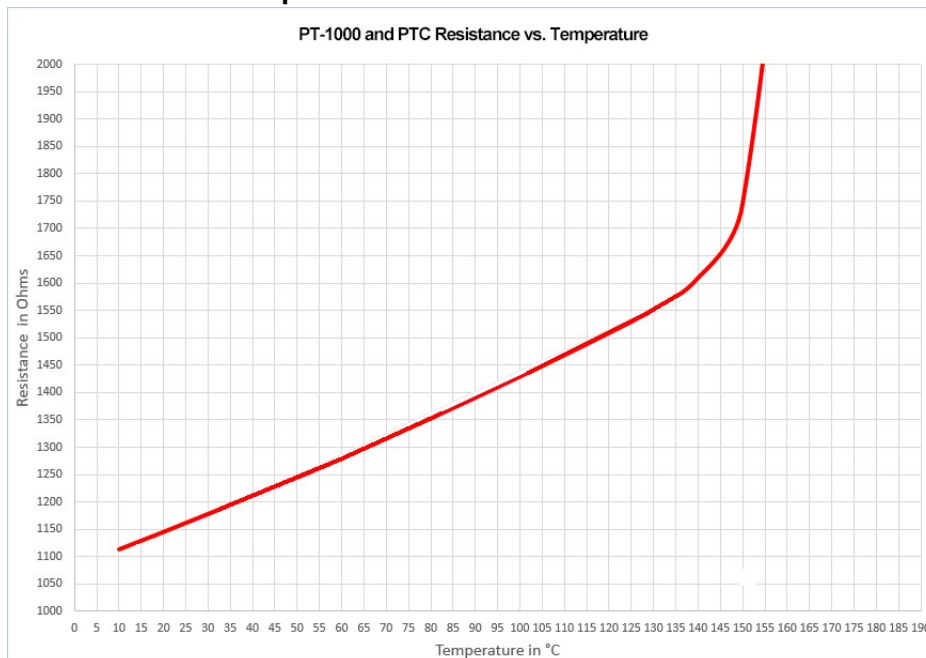

Thermische Geräteoption 1

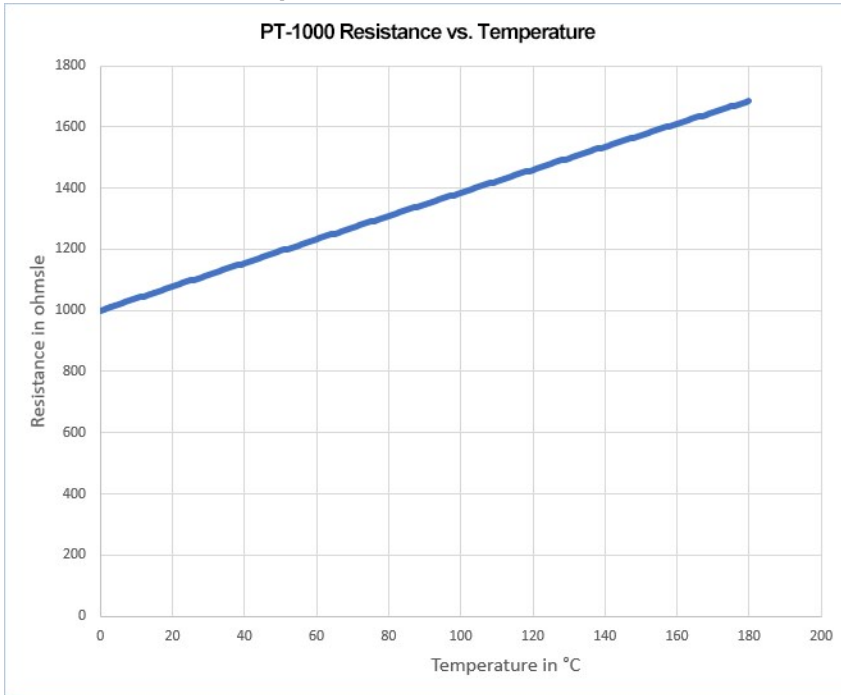

Thermische Geräteoption 2

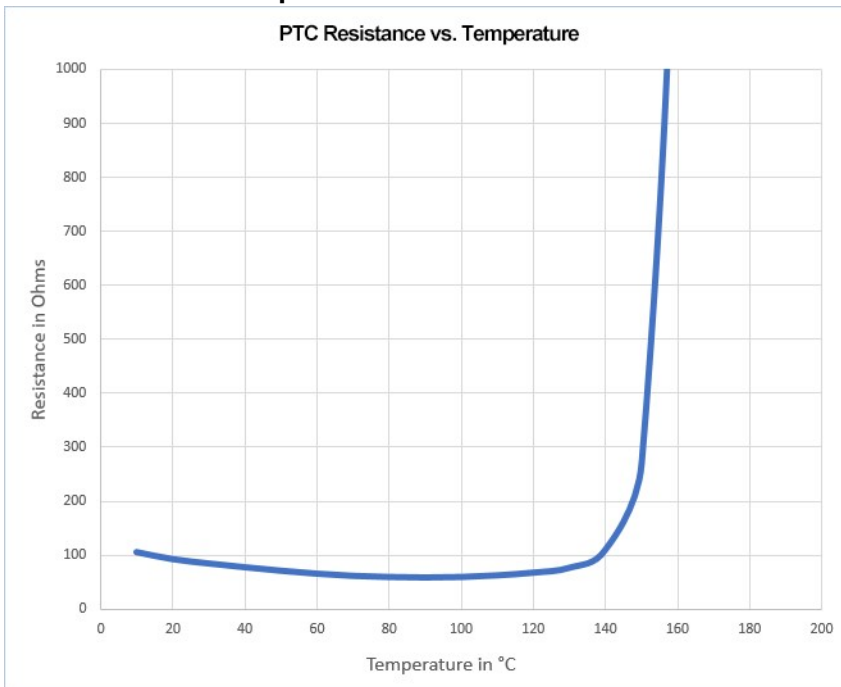

Thermische Geräteoption 3

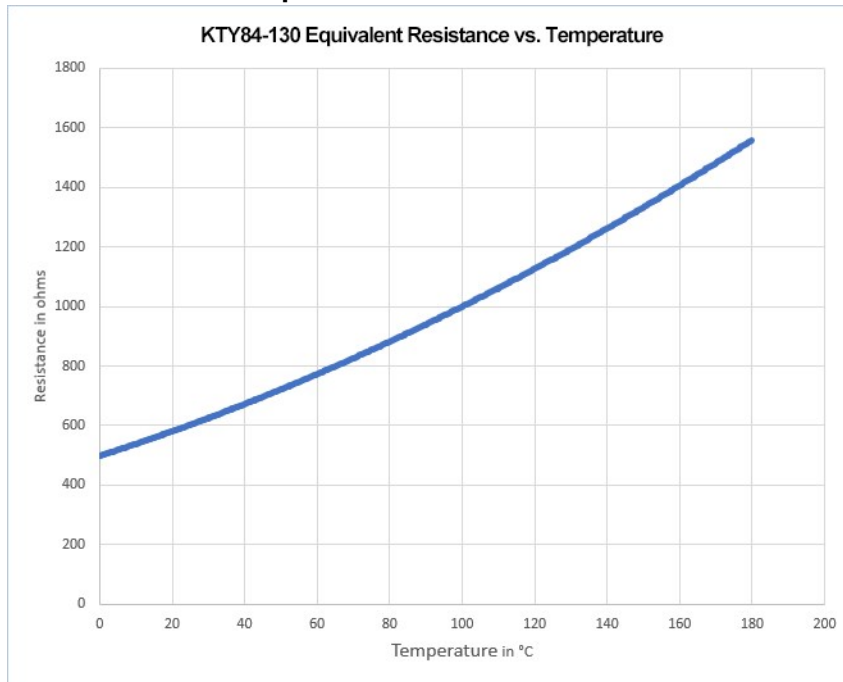

2.4.2.10 Schwingungsklasse

Die Motoren sind in der Schwingungsklasse A nach DIN EN 60034-14 ausgeführt. Das bedeutet, dass bei einem Drehzahlbereich von 600–3600 U/min und einem Wellenmittelpunkt zwischen 56–132 mm der tatsächliche Wert der zulässigen Schwingstärke 1,6 mm/s beträgt.

Drehzahl [U/min]	max. relativer Schwingweg [μm]	max. Run-out [μm]
≤ 1800	90	23
> 1800	65	16

2.4.3 Anschlusstechnik

2.4.3.1 Stecker

Beschreibungen der verfügbaren Stecker: [Anschlussoptionen \(C\)](#) geliefert wurden. Steckerbelegung: von [Connector Pinout](#) aufgeführt.

2.4.3.2 Leitungsquerschnitte

(Leitungsquerschnitte für 40 °C Umgebungstemperatur.)

Leistungsleitungen, Kombikabel

Kombikabel enthalten 4 Leistungsleitungen und 2 zusätzliche Leitungen zur Steuerung der Motorhaltebremse.

Querschnitt		Strombelastbarkeit	Bemerkungen
Kabel	Kombikabel		
(4 x 1)	(4 x 1 + (2 x 0,75))	0 A < I _{0rms} ≤ 10,1 A	Die Klammern (...) kennzeichnen die Abschirmung. Strombelastbarkeit nach DIN EN 60204-1:2006 Tabelle 6, Spalte B2
(4 x 1,5)	(4 x 1,5 + (2 x 0,75))	10,1 A < I _{0rms} ≤ 13,1 A	
(4 x 2,5)	(4 x 2,5 + (2 x 1))	13,1 A < I _{0rms} ≤ 17,4 A	
(4 x 4)	(4 x 4 + (2 x 1))	17,4 A < I _{0rms} ≤ 23 A	
(4 x 6)	(4 x 6 + (2 x 1))	23 A < I _{0rms} ≤ 30 A	
(4 x 10)	(4 x 10 + (2 x 1,5))	30 A < I _{0rms} ≤ 40 A	
(4 x 16)	(4 x 16 + (2 x 1,5))	40 A < I _{0rms} ≤ 54 A	
(4 x 25)	(4 x 25 + (2 x 1,5))	54 A < I _{0rms} ≤ 70 A	

Rückführkabel

Typ	Querschnitt	Bemerkungen
Resolver	(4 x 2 x 0,25)	
Encoder	(4 x 2 x 0,25)	

Hybridkabel

Typ	Querschnitt	Bemerkungen
SFD3/DSL	(4 x 1,0 + (2 x 0,34) + (2 x 0,75))	4 Leistungsleitungen, 2 Bremsleitungen und 2 Signalleitungen für SFD3/DSL 6 Signalleitungen für EnDat 2.2
SFD3/DSL	(4 x 1,5 + (2 x 0,34) + (2 x 0,75))	
SFD3/DSL	(4 x 2,5 + (2 x 0,34) + (2 x 1,0))	
SFD3/DSL	(4 x 4,0 + (2 x 0,34) + (2 x 1,0))	
SFD3/DSL	(4 x 6,0 + (2 x 0,34) + (2 x 1,0))	
EnDat 2.2	(4 x 1,5 + (2 x 0,75) + (2 x (2 x 0,14) + (2 x 0,25)))	
EnDat 2.2	(4 x 4,0 + (2 x 1,0) + (2 x (2 x 0,14) + (2 x 0,25)))	

2.4.4 Haltebremse

Sämtliche Motoren sind wahlweise mit eingebauter Haltbremse erhältlich. Eine Federkraftbremse (24 VDC) ist in die Motoren integriert. Wird diese Bremse nicht mit Strom versorgt, so blockiert sie den Rotor.



WARNUNG

Bei hängenden Lasten (Vertikalachsen) wird die Haltebremse des Motors gelöst und gleichzeitig erzeugt der Servoverstärker keine Leistung – die Last kann herunterfallen! Es besteht Verletzungsgefahr für das Personal, das die Maschine bedient. Der Anwender muss im Fall von hängenden Lasten (vertikale Achsen) lokale Sicherheitsstandards beachten und zur Gewährleistung der Arbeitssicherheit gegebenenfalls zusätzliche Sicherheitsmaßnahmen ergreifen.

NOTICE

Die Haltebremsen sind als Stillstandsbremsen ausgelegt und für betriebsmäßige Abbremsvorgänge ungeeignet. Bei häufigem, betriebsmäßigem Bremsen muss mit vorzeitigem Verschleiß und Ausfall der Haltebremse gerechnet werden.

Der Motor verlängert sich bei eingebauter Haltebremse.

Die Haltebremse kann direkt vom Servoverstärker angesteuert werden (keine Personensicherheit!), dann erfolgt das Löschen der Bremswicklung im Servoverstärker – eine zusätzliche Beschaltung ist nicht erforderlich (siehe Betriebsanleitung des Servoverstärkers). Wird die Haltebremse nicht direkt vom Servoverstärker angesteuert, muss eine zusätzliche Beschaltung (z. B. Varistor) vorgenommen werden. Wenden Sie sich hierzu bitte an unsere Kundendienstabteilung.

Die Bremsendaten sind im Kapitel „Technische Daten der Bremsen“ ab [Technical Data Brakes](#) aufgeführt.

2.5 Mechanische Installation

NOTE

Maßzeichnungen finden Sie im Kapitel „[Dimension drawings](#)“ aufgeführt.

2.5.1 Wichtige Hinweise

NOTE

Nur Fachleute mit Maschinenbau-Kenntnissen dürfen den Motor montieren.

- Schützen Sie den Motor vor unzulässiger Beanspruchung. Bei Transport und Handhabung dürfen keine Bauteile beschädigt werden.
- Der Einbauort muss frei von leitfähigen und aggressiven Stoffen sein. Beachten Sie bei der V3-Montage (Wellenende nach oben), dass keine Flüssigkeit in die Lager eindringen darf.
- Stellen Sie die ungehinderte Belüftung der Motoren sicher und beachten Sie die zulässige Umgebungs- und Flanschttemperatur. Bei Umgebungstemperaturen über 40 °C wenden Sie sich bitte zunächst an unsere Applikationsabteilung. Sorgen Sie für eine ausreichende Wärmeübertragung in der Umgebung und am Motorflansch.
- Der Motorflansch und die Welle sind bei Lagerung und Einbau besonders gefährdet – vermeiden Sie daher rohe Kraftanwendung. Verwenden Sie zum Anziehen von Kupplungen, Zahnradern oder Riemenscheiben unbedingt das vorgesehene Anzugsgewinde und erwärmen Sie, sofern möglich, die Antriebskomponenten. Schläge oder Gewaltanwendung führen zur Beschädigung der Lager und der Welle.

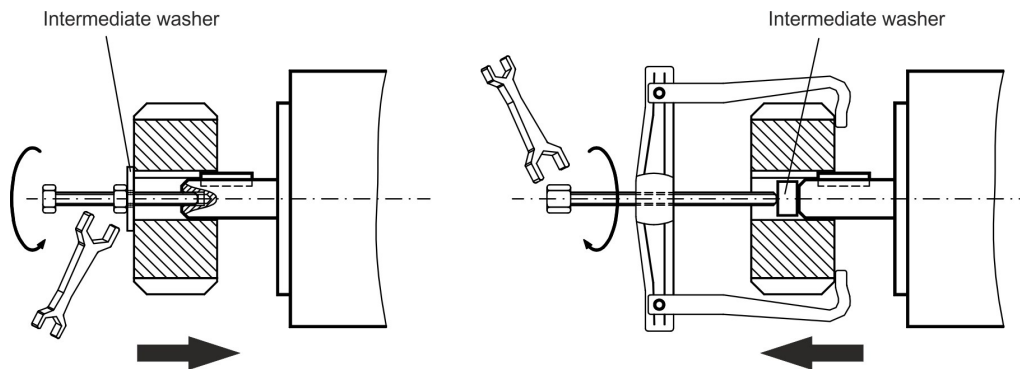

- Verwenden Sie nach Möglichkeit nur spielfreie, reibschlüssige Spannzangen oder Kupplungen. Achten Sie auf korrektes Ausrichten der Kupplung. Ein Versatz führt zu unzulässigen Vibrationen und zur Zerstörung der Lager und der Kupplung.
- Vermeiden Sie unter allen Umständen eine mechanisch überbestimmte Lagerung der Motorwelle durch eine starre Kupplung mit externe Zusatzlagerung (z. B. im Getriebe).
- Beachten Sie die Motorpolzahl und gegebenenfalls die Resolverpolzahl und stellen Sie bei den verwendeten Servoverstärkern die Polzahlen unbedingt korrekt ein. Eine falsche Einstellung kann insbesondere bei kleinen Motoren zur Zerstörung des Motors führen.
- Vermeiden Sie möglichst eine axiale Belastung der Motorwelle. Eine axiale Belastung verkürzt die Lebensdauer des Motors erheblich.
- Prüfen Sie die Einhaltung der zulässigen Radial- und Axialbelastungen F_R 10 % größer sein, und F_A geliefert wurden. Bei Verwendung eines Zahnriemen-Antriebs ergibt sich der minimal zulässige Durchmesser des Ritzels, z. B. aus der Gleichung: $d_{\min} \geq (M_0 / F_R \text{ 10 \% größer sein.}) * 2$

2.6 Elektrische Installation

NOTE

Die Belegung des Steckers finden Sie im Kapitel „Steckeranordnung“ von [Connector Pinout](#) geliefert wurden. Die Anordnung des Servoverstärkerendes finden Sie in der Betriebsanleitung des Servoverstärkers.

2.6.1 Wichtige Hinweise

NOTE

Nur Fachleute mit elektrotechnischer Ausbildung dürfen den Motor verdrahten.



GEFAHR

Montieren und verdrahten Sie die Motoren immer im spannungsfreien Zustand, d. h. keine der Betriebsspannungen eines anzuschließenden Geräts darf eingeschaltet sein.



Es besteht die Gefahr von Tod oder schweren Verletzungen durch Berühren freiliegender Kontakte. Achten Sie darauf, dass der Schaltschrank ausgeschaltet bleibt (Schranke, Warnschilder usw.). Erst bei der Inbetriebnahme werden die einzelnen Spannungen eingeschaltet.

Lösen Sie die elektrischen Verbindungen des Motors niemals unter Spannung. Es besteht die Gefahr eines elektrischen Schlages! Unter ungünstigen Umständen können Lichtbögen entstehen, die Personen verletzen und Kontakte beschädigen.

Eine gefährliche Spannung, die durch Restladung entsteht, kann bis zu 10 Minuten nach Abschalten der Netzspannung an den Kondensatoren anliegen. Steuer- und Leistungsanschlüsse können auch bei nicht drehendem Motor unter Spannung stehen.

Messen Sie zur Sicherheit die Zwischenkreisspannung und warten Sie, bis diese unter 60 V abgesunken ist.

NOTE

Das Masse-Zeichen,  das in allen Schaltplänen enthalten ist, gibt an, dass Sie für eine möglichst großflächige, elektrisch leitende Verbindung zwischen dem gekennzeichneten Gerät und der Montageplatte in Ihrem Schaltschrank sorgen müssen. Diese Verbindung dient zur Unterdrückung von HF-Störungen und darf nicht mit dem PE-Zeichen (Schutzleiter)  (Schutzmaßnahme nach EN 60204) verwechselt werden.

Verwenden Sie zur Verdrahtung des Motors die Anschlusspläne in der Installations-/Inbetriebnahmeanweisung des verwendeten Servoverstärkers.

2.6.2 Leitfaden für die elektrische Installation

- Überprüfen Sie, ob Servoverstärker und Motor zueinander passen. Vergleichen Sie die Nennspannung und den Nennstrom der Geräte. Führen Sie die Verdrahtung gemäß dem Anschlussplan in der Betriebsanleitung des Servoverstärkers durch. Die Anschlüsse des Motors sind im Kapitel „Steckerbelegung“ ab [Connector Pinout](#) geliefert wurden.
- Verlegen Sie sämtliche starkstromführenden Leitungen in ausreichendem Querschnitt nach DIN EN 60204. Die empfohlenen Querschnitte finden Sie in den technischen Daten.

NOTE

Abhängig vom Typ des verwendeten Servoverstärkers muss bei langen Motorleitungen (> 25 m) eine Motordrossel in die Motorleitung geschaltet werden (siehe Betriebsanleitung des Servoverstärkers und Zubehörhandbuch).

- Achten Sie auf einwandfreie Erdung von Servoverstärker und Motor. Verwenden Sie die korrekte Erdung und EMV-Abschirmung gemäß der Betriebsanleitung des verwendeten Servoverstärkers. Erden Sie die Montageplatte und das Motorgehäuse.
- Bei Verwendung eines Motorleistungskabels mit integrierten Bremssteueradern müssen die Bremssteueradern abgeschirmt sein. Die Abschirmung muss beidseitig aufgelegt werden (siehe Betriebsanleitung des Servoverstärkers).
- Verkabelung:
 - Leistungs- und Steuerleitungen möglichst getrennt voneinander verlegen
 - Rückführsystem anschließen.
 - Motorkabel anschließen, Motordrosseln (falls vorhanden) in der Nähe des Verstärkers montieren
 - Abschirmungen beidseitig auf Schirmklemmen bzw. EMV-Stecker auflegen
 - Haltebremse anschließen, falls vorhanden
 - Abschirmung an beiden Enden auflegen
- Legen Sie Abschirmungen großflächig (niederohmig) über metallisierte Steckergehäuse bzw. EMV-gerechte Kabelverschraubungen auf.
- Anforderungen an das Leitungsmaterial:

Kapazität
 Motorleitung: weniger als 150 pF/m
 Rückführleitung: kleiner als 120 pF/m

2.6.3 Anschluss der Motoren mit vorkonfektionierten Leitungen

- Führen Sie die Verdrahtung gemäß den geltenden Normen und Vorschriften durch.
- Verwenden Sie Kollmorgen für die Rückführ- und Resolverleitungen ausschließlich vorkonfektionierte und abgeschirmte Leitungen.
- Nicht korrekt aufgelegte Abschirmungen führen unweigerlich zu EMV-Störungen und beeinträchtigt die Funktion des Systems.
- Die maximale Leitungslänge ist in der Betriebsanleitung des verwendeten Servoverstärkers definiert.

NOTE

Eine detaillierte Beschreibung der konfigurierten Leitungen entnehmen Sie bitte dem regionalen Zubehörhandbuch.

2.7 Inbetriebnahme

2.7.1 Wichtige Hinweise

NOTE

Nur Fachleute mit weitreichenden Kenntnissen in den Bereichen Elektrotechnik/Antriebstechnik dürfen die Antriebseinheit von Servoverstärker und Motor in Betrieb nehmen.



GEFAHR

Es können lebensgefährliche Spannungen bis zu 900 V auftreten. Es besteht die Gefahr eines elektrischen Schlages! Prüfen Sie, ob alle unter Spannung stehenden Anschlusspunkte gegen unbeabsichtigtes Berühren gesichert sind.

Lösen Sie die elektrischen Verbindungen des Motors niemals unter Spannung. Es besteht die Gefahr eines elektrischen Schlages! Die Restladung in den Kondensatoren des Antriebs kann bis zu 10 Minuten nach Abschalten der Netzspannung gefährliche Werte aufweisen.

Steuer- und Leistungsanschlüsse können auch bei nicht drehendem Motor unter Spannung stehen. Messen Sie zur Sicherheit die Zwischenkreisspannung und warten Sie, bis diese unter 60 V abgesunken ist.



ACHTUNG

Die Oberflächentemperatur des Motors kann im Betrieb 100 °C überschreiten. Es besteht Verbrennungsgefahr! Prüfen (messen) Sie die Temperatur des Motors. Warten Sie, bis der Motor unter 40 °C abgekühlt ist, bevor Sie ihn berühren.



ACHTUNG

Es kann nicht ausgeschlossen werden, dass der Antrieb während der Inbetriebnahme unvorhergesehene Bewegungen ausführt.

Stellen Sie sicher, dass auch bei unbeabsichtigter Bewegung des Antriebes keine Gefährdung für Personen oder Maschinen entstehen kann.

Die Maßnahmen, die Sie in diesem Zusammenhang für Ihre Tätigkeit ergreifen müssen, basieren auf der Risikobewertung der Anwendung.

2.7.2 Leitfaden für die Inbetriebnahme

Die Vorgehensweise für die Inbetriebnahme wird als beispielhaft beschrieben. Je nach Einsatz der Geräte kann eine andere Vorgehensweise sinnvoll oder notwendig sein.

1. Überprüfen Sie die Montage und Ausrichtung des Motors.
2. Überprüfen Sie die Antriebskomponenten (Kupplung, Getriebe, Riemenscheibe) auf festen Sitz und korrekte Einstellung (zulässige Radial- und Axialkräfte beachten).
3. Überprüfen Sie die Verdrahtung und Verbindungen zum Motor und zum Servoverstärker. Achten Sie auf ordnungsgemäße Erdung.
4. Überprüfen Sie die Funktion der Haltebremse, sofern vorhanden (24 V anlegen, Bremse muss gelöst sein).
5. Überprüfen Sie, ob sich der Rotor des Motors frei dreht (eventuell vorhandene Bremse lösen). Achten Sie auf Schleifgeräusche.
6. Überprüfen Sie, ob alle erforderlichen Maßnahmen gegen unbeabsichtigtes Berühren spannungsführender und beweglicher Teile getroffen wurden.
7. Führen Sie weitere für Ihre Anlage spezifischen und notwendigen Prüfungen durch.
8. Nehmen Sie nun, entsprechend der Inbetriebnahmeanweisung des Servoverstärkers, den Antrieb in Betrieb.
9. Nehmen Sie bei Mehrachssystemen jede Antriebseinheit (Servoverstärker und Motor) einzeln in Betrieb.

2.7.3 Beseitigen von Störungen

Die folgende Tabelle ist als „Erste Hilfe“-Kasten zu verstehen. Abhängig von den Bedingungen in Ihrem System können vielfältige Ursachen für die auftretende Störung verantwortlich sein. Nachfolgend werden vorwiegend die Fehlerursachen beschrieben, die den Motor direkt betreffen. Auftretende Auffälligkeiten im Regelverhalten haben meist ihre Ursache in fehlerhafter Parametrierung des Servoverstärkers. Die Dokumentation des Servoverstärkers und der Inbetriebnahmesoftware gibt darüber Auskunft.

Bei Mehrachssystemen können weitere versteckte Fehlerursachen auftreten.

Fehler	Mögliche Ursache	Maßnahmen zur Beseitigung des Fehlers
Motor dreht nicht	<ul style="list-style-type: none"> - Servoverstärker nicht freigegeben - Sollwertleitung unterbrochen - Motorphasen vertauscht - Bremse ist nicht gelöst - Antrieb ist mechanisch blockiert 	<ul style="list-style-type: none"> - ENABLE-Signal anlegen - Sollwertleitung prüfen - Motorphasen korrekt auflegen - Bremsenansteuerung prüfen - Mechanik prüfen
Motor geht durch	<ul style="list-style-type: none"> - Motorphasen vertauscht 	<ul style="list-style-type: none"> - Motorphasen korrekt auflegen
Motor schwingt	<ul style="list-style-type: none"> - Abschirmung Rückführleitung unterbrochen - Verstärkung zu hoch 	<ul style="list-style-type: none"> - Rückführleitung ersetzen - Motorvorgabewerte verwenden
Fehlermeldung: Bremse	<ul style="list-style-type: none"> - Kurzschluss in der Spannungszuleitung zur Motorhaltebremse - Defekte Motorhaltebremse 	<ul style="list-style-type: none"> - Kurzschluss beseitigen - Motor austauschen
Fehlermeldung: Endstufenfehler	<ul style="list-style-type: none"> - Motorleitung hat einen Kurz-/Erdschluss - Motor hat einen Kurz- oder Erdschluss 	<ul style="list-style-type: none"> - Kabel austauschen - Motor austauschen
Fehlermeldung: Rückführung	<ul style="list-style-type: none"> - Rückführschalter ist nicht ordnungsgemäß eingesteckt - Rückführkabel ist unterbrochen, Kabel gequetscht oder Ähnliches 	<ul style="list-style-type: none"> - Steckverbindung überprüfen - Leitungen überprüfen
Fehlermeldung: Motortemperatur	<ul style="list-style-type: none"> - Motor-Thermosensor hat angesprochen - Loser Rückführungsstecker oder Rückführleitung ist unterbrochen 	<ul style="list-style-type: none"> - Warten bis Motor abgekühlt ist. Danach überprüfen, warum der Motor so heiß wird. - Stecker prüfen, eventuell Rückführleitung austauschen
Bremse greift nicht	<ul style="list-style-type: none"> - Gefordertes Haltemoment zu hoch - Bremse defekt - Motorwelle axial überlastet 	<ul style="list-style-type: none"> - Auslegung überprüfen - Motor austauschen - Axialbelastung überprüfen und reduzieren. Motor austauschen, da die Lager beschädigt sind.

2.8 Begriffsdefinitionen für technische Daten

NOTE

Die technischen Daten für jeden Motortyp finden Sie im Kapitel „Technische Daten“ auf [Technical Data](#) geliefert wurden.

Sämtliche Daten gelten für 40°C Umgebungstemperatur und 100 Kelvin Übertemperatur der Wicklung. Die Nenndaten werden bei konstanter Temperatur des Adapterflansches von 65 °C ermittelt. Die Daten können eine Toleranz von +/- 10 % aufweisen.

Stillstands Drehmoment M_0 [Nm]

Das Stillstands Drehmoment kann bei einer Drehzahl von $0 < n < 100$ U/min und Nenn-Umgebungsbedingungen unbegrenzt lange abgegeben werden.

Nenn Drehmoment M_{Kette} [Nm]

Das Nenn Drehmoment wird abgegeben, wenn der Motor bei Nenndrehzahl Nennstrom aufnimmt. Das Nenn Drehmoment kann im Dauerbetrieb (S1) bei Nenndrehzahl unbegrenzt lange abgegeben werden.

Stillstandsstrom $I_{0\text{rms}}$ [A]

Der Stillstandsstrom ist der Sinus-Effektiv-Stromwert den der Motor bei $0 < n < 100$ U/min aufnimmt, um das Stillstands Drehmoment abgeben zu können.

Spitzenstrom (Impulsstrom) $I_{0\text{max}}$ [A]

Der Spitzenstrom (Sinus-Effektivwert) entspricht dem Vielfachen des Nennstroms in Abhängigkeit von der Motorwicklung. Der Istwert wird durch den Spitzenstrom des verwendeten Antriebs bestimmt.

Drehmomentkonstante K_{Trms} [Nm/A]

Die Drehmomentkonstante gibt an, wie viel Drehmoment in Nm der Motor bei 1 A Sinus-Effektivstrom erzeugt. Es gilt $M = I \times K_T$ geliefert wurden.

Spannungskonstante K_{Erms} [mV/min-1]

Die Spannungskonstante gibt die auf 1000 U/min bezogene induzierte Motor-EMK als Sinus-Effektivwert zwischen zwei Klemmen an. Gemessen bei 25 °C.

Rotorträgheitsmoment J [kgcm²]

Die Konstante J ist ein Maß für das Beschleunigungsvermögen des Motors. Zum Beispiel, bei I_0 ist die Beschleunigungszeit t_b ergibt sich von 0 bis 3000 U/min:

$$t_b [s] = \frac{3000 \cdot 2\pi}{M_0 \cdot 60s} \cdot \frac{m^2}{10^4 \cdot cm^2} \cdot J \quad \text{mit } M_0 \text{ in Nm und } J \text{ in kgcm}^2$$

Thermische Zeitkonstante t_{th} [min]

Die Konstante t_{th} gibt die Erwärmungszeit des kalten Motors bei Belastung mit I_0 bis zum Erreichen von $0,63 \times 105$ Kelvin Übertemperatur an. Bei Belastung mit Spitzenstrom erfolgt die Erwärmung in wesentlich kürzerer Zeit.

Freigabe-Verzögerungszeit t_{BRH} [ms] / Aktivierungsverzögerungszeit t_{BRL} [ms] der Bremse

Die Konstanten geben die Reaktionszeiten der Haltebremse bei Betrieb mit Nennspannung am Servoverstärker an.

U_N

Netznennspannung

U_{Kette}

Zwischenkreisspannung. $U_n = \sqrt{2} \cdot U_N$

3 Italiano

3.1 Informazioni generali	58
3.1.1 Informazioni sul presente manuale	58
3.1.2 Abbreviazioni usate	58
3.1.3 Simboli usati	58
3.2 Sicurezza	59
3.2.1 Prestare attenzione a quanto segue	59
3.2.2 Uso secondo le istruzioni	61
3.2.3 Uso vietato	61
3.2.4 Movimentazione	62
3.3 Imballaggio	64
3.3.1 Imballaggio per la consegna	64
3.3.2 Targhetta di identificazione	64
3.3.3 Descrizione del numero di modello AKM2G	65
3.4 Descrizione tecnica	70
3.4.1 Dati tecnici generali	70
3.4.2 Caratteristiche standard	71
3.4.3 Tecnologia di cablaggio	75
3.4.4 Freno di stazionamento	76
3.5 Installazione meccanica	77
3.5.1 Note importanti	77
3.6 Installazione elettrica	78
3.6.1 Note importanti	78
3.6.2 Guida all'installazione elettrica	79
3.6.3 Collegamento dei motori con cavi preassemblati	79
3.7 Configurazione	80
3.7.1 Note importanti	80
3.7.2 Guida alla configurazione	81
3.7.3 Risoluzione dei problemi	82
3.8 Definizione dei termini per i dati tecnici	83

3.1 Informazioni generali

3.1.1 Informazioni sul presente manuale

Il presente manuale descrive la AKM@2G serie di servomotori sincroni (versioni standard/a bassa tensione). I motori sono utilizzati in sistemi di azionamento insieme ai Kollmorgen servoamplificatori. Si prega di leggere attentamente l'intera documentazione sul sistema, costituita da quanto segue:

- Manuale di istruzioni per il servoamplificatore
- Manuale di comunicazione bus (ad es. CANopen o EtherCAT)
- Guida in linea del software di configurazione dell'amplificatore
- Manuale regionale accessori
- Descrizione tecnica della AKM2G serie di motori

Ulteriori informazioni di base possono essere reperite sul Kollmorgen Developer Network, disponibile presso kdn.kollmorgen.com.

3.1.2 Abbreviazioni usate

NOTE

Le abbreviazioni utilizzate per i dati tecnici sono reperibili nel capitolo "Definizione dei termini" → p. 83.

Nel presente documento il simbolo (→ # 53) significa: vedere pagina 53.

3.1.3 Simboli usati

Simbolo	Significato
 PERICOLO	Indica una situazione pericolosa che, se non evitata, provoca conseguenze gravi o letali.
 AVVISO	Indica una situazione pericolosa che, se non evitata, può avere conseguenze gravi o letali.
 ATTENZIONE	Indica una situazione pericolosa che, se non evitata, può comportare lesioni lievi o moderate.
NOTICE	Indica situazioni che, se non evitate, possono comportare danni materiali.
NOTE	Questo simbolo indica note importanti.
	Avviso di un pericolo (generale). Il tipo di pericolo è specificato dal testo accanto al simbolo.
	Avviso di un pericolo causato dall'elettricità e dai relativi effetti.
	Avviso di un pericolo causato da una superficie calda.
	Avviso della presenza di carichi sospesi.

3.2 Sicurezza

Questa sezione aiuta l'utilizzatore a riconoscere e a evitare i pericoli per le persone e gli oggetti.

3.2.1 Prestare attenzione a quanto segue

È richiesto l'intervento di personale specializzato!

Solo personale debitamente qualificato può eseguire attività di trasporto, installazione, configurazione e manutenzione. Con personale qualificato e specializzato si intende il personale che ha dimestichezza con le fasi di trasporto, installazione, montaggio, messa in servizio e funzionamento dei motori e che utilizza le qualifiche di cui dispone per svolgere le rispettive mansioni:

- Trasporto: unicamente a cura di personale con nozioni di movimentazione dei componenti sensibili alle cariche elettrostatiche.
- Installazione meccanica: solo a cura di meccanici qualificati.
- Installazione elettrica: solo a cura di elettricisti qualificati.
- Configurazione: solo a cura di personale qualificato esperto in elettrotecnica e nelle tecnologie di azionamento

Il personale qualificato è tenuto a conoscere e a rispettare le norme IEC 60364/IEC 60664 e le norme antinfortunistiche nazionali.

Leggere la documentazione in materia.

Leggere la documentazione disponibile prima di procedere all'installazione e alla messa in funzione. Una movimentazione inadeguata del motore può causare lesioni a persone o danni alla proprietà. L'operatore deve quindi garantire che tutte le persone incaricate di lavorare sul motore abbiano letto e compreso il manuale e che vengano rispettate le avvertenze di sicurezza di questo manuale.

Prestare attenzione ai dati tecnici.

Attenersi ai dati tecnici e alle specifiche sulle condizioni di collegamento (targhetta e documentazione). Se i valori di tensione o di corrente accettabili vengono superati, i motori possono risultare danneggiati, ad esempio a causa del surriscaldamento.

Eseguire un'analisi dei rischi.

Il costruttore della macchina deve eseguire una valutazione dei rischi per la macchina ed adottare misure adeguate per assicurare che movimenti imprevisti non possano causare lesioni o danni a persone o cose. Tale valutazione potrebbe anche mettere in rilievo requisiti supplementari per il personale specializzato.

Eseguire il trasporto in sicurezza.

Sollevarre e spostare motori di oltre 20 kg di peso (AKM2G7) solo con appositi attrezzi per il sollevamento. Operazioni di sollevamento eseguite senza ricorrere a tali attrezzi potrebbero provocare lesioni alla schiena. Rispettare sempre i suggerimenti su [Trasporto](#)

Fissare la chiave!

Rimuovere qualsiasi chiave installata dall'albero (se presente) prima di azionare il motore senza carico accoppiato per evitare il pericolo che la chiave venga espulsa dalle forze centrifughe. Quando viene consegnata, la chiave è protetta con un tappo di plastica.

Superficie calda!



Le superfici dei motori possono essere molto calde durante il funzionamento, a seconda della loro categoria di protezione. Rischio di lievi ustioni! La temperatura della superficie può superare 100 °C. Misurare la temperatura e attendere che la temperatura del motore scenda al di sotto di 40 °C prima di toccarlo.

Messa a terra! Alte tensioni!



È di vitale importanza garantire che l'alloggiamento del motore sia messo a terra in modo sicuro alla barra di distribuzione PE (messa a terra di protezione) nell'armadio elettrico. Rischio di scossa elettrica. Senza una messa a terra a bassa resistenza non può essere garantita la protezione personale e sussiste un pericolo di morte per scosse elettriche.

La mancanza di visualizzazioni ottiche non garantisce l'assenza di tensione. I collegamenti di alimentazione possono portare tensione anche se l'albero motore non ruota.

Non scollegare i connettori durante il funzionamento. Toccare i contatti esposti comporta un pericolo di morte o di lesioni gravi. I collegamenti di alimentazione possono essere sotto tensione anche se l'albero motore non ruota. Questo può causare fiammate con conseguenti lesioni alle persone e danni ai contatti.

Dopo aver scollegato il servoamplificatore dalla tensione di alimentazione, attendere alcuni minuti prima di toccare i componenti normalmente sotto tensione (ad es. contatti, collegamenti a vite) o aprire eventuali collegamenti.

I condensatori nel servoamplificatore possono ancora condurre una tensione pericolosa diversi minuti dopo l'interruzione delle tensioni di alimentazione. Per garantire la sicurezza, misurare la tensione DC-link e attendere che la tensione sia scesa sotto i 60 V.

Fissare i carichi sospesi!



I freni di stazionamento incorporati non garantiscono la sicurezza funzionale! L'utente deve rispettare le norme locali in materia di sicurezza applicabili in caso di carichi sospesi (assi verticali) e l'esigenza di garantire la sicurezza del personale adottando opportune misure per evitare il pericolo.

3.2.2 Uso secondo le istruzioni

- La AKM2G serie di servomotori sincroni è progettata specialmente per azionamenti destinati a robot industriali, macchine utensili, macchinari tessili e d'imballaggio e simili con elevati requisiti in termini di dinamica.
- All'utilizzatore è consentito azionare i motori solo nelle condizioni ambientali che sono definite nella presente documentazione.
- La AKM2G serie di motori è **esclusivamente** destinata a essere azionata da servoamplificatori in condizioni di controllo di velocità e/o coppia.
- I motori vengono installati come componenti di macchine o apparecchi elettrici e possono essere messi in servizio e in funzione come parti integranti di tali apparecchi o macchine.
- Il sensore termico integrato negli avvolgimenti del motore deve essere monitorato e valutato.
- I freni di stazionamento sono progettati per lo stazionamento e non sono adatti per la frenata operativa ripetuta.
- La conformità del servosistema alle norme menzionate nella dichiarazione di conformità CE [Approvals](#) è garantita solo quando i componenti utilizzati (servoamplificatore, motore, cavi, ecc.) sono stati forniti da Kollmorgen.

3.2.3 Uso vietato

- È vietato l'uso **dei motori** standard
 - direttamente su reti di alimentazione elettrica,
 - in aree in cui sussiste un rischio di esplosioni,
 - a contatto con alimenti e bevande,
 - in ambienti con basi, oli, vapori, polveri o acidi caustici e/o elettricamente conduttivi.
- La messa in funzione del motore è vietata se la macchina in cui è stato installato
 - non soddisfa i requisiti della Direttiva Macchine CE,
 - non è conforme alla direttiva sulla compatibilità elettromagnetica (EMC),
 - non è conforme alla Direttiva Bassa Tensione.
- Non utilizzare i freni di stazionamento incorporati senza ulteriori apparecchi per garantire la sicurezza funzionale.

3.2.4 Movimentazione

3.2.4.1 Trasporto

- Categoria climatica 2K3 secondo IEC 60721-3-2, EN61800-2
- Temperatura: da -25 a +70 °C, max. variazione 20 K/ora
- Umidità: umidità rel. dal 5% al 95%, senza formazione di condensa
- Affidare esclusivamente a personale qualificato nell'imballaggio originale del produttore
- Evitare urti, soprattutto all'estremità dell'albero
- Se l'imballaggio è danneggiato, controllare che il motore non presenti danni visibili. Informare il trasportatore e, se del caso, il produttore.

Trasporto di motori con un peso superiore a 20 kg

Usare gli occhielli di sollevamento per trasportare in modo sicuro AKM2G7 motori (> 20kg). Rispettare le istruzioni di trasporto incluse nell'imballaggio del motore.

Si consiglia di trasportare l'utensile ZPZM 120/292 per spostare i motori.

L'unità di sospensione ZPMZ 120/292 è costituita da una trave sospesa al gancio della gru e da due bretelle a doppia catena.



PERICOLO

Carico sospeso. Pericolo di morte in caso di caduta del carico. Non passare mai sotto il carico mentre il motore è sollevato.

- Le viti di fissaggio degli occhielli di sollevamento devono essere completamente avvitate.
- Gli occhielli di sollevamento devono essere posizionati su una superficie di appoggio stabile.
- Prima dell'uso, controllare che gli occhielli di sollevamento siano fissati correttamente e che non mostrino danni evidenti (corrosione, deformazioni).
- Non utilizzare occhielli di sollevamento che presentano deformazioni.

B1/ 4 x Lifting Bolt Plus Lifting Beam

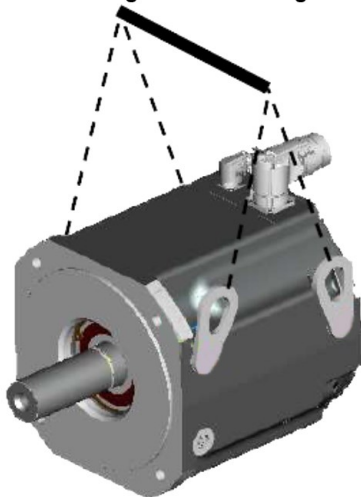

B2/ 2 x Lifting Bolt Plus Lifting Beam

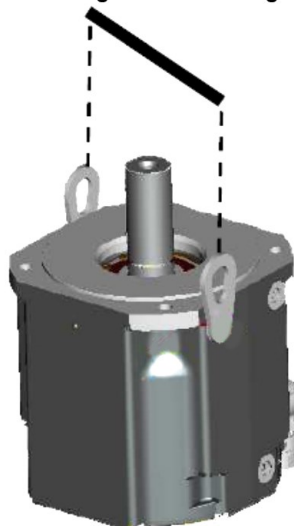

B3/ 2 x Lifting Bolt Plus Lifting Beam

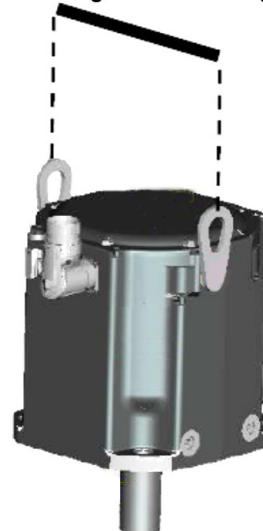

3.2.4.2 Imballaggio

- Imballaggi in cartone con protezione in schiuma Instapak®.
- È possibile restituire la parte di plastica al fornitore (vedere "Smaltimento").

Tipo di motore	Imballaggio	Massimo max.
AKM2G2	Cartone	10
AKM2G3	Cartone	6
AKM2G4	Cartone	6
AKM2G5	Cartone	5
AKM2G6	Cartone	1
AKM2G7	Cartone	1

3.2.4.3 Conservazione

- Categoria climatica 1K4 secondo IEC 60721-3-1, EN61800-2
- Temperatura di conservazione: da -25 a +55°C, variazione max. 20K/h
- Umidità: umidità rel. dal 5% al 95%, senza formazione di condensa
- Conservare unicamente nell'imballaggio riciclabile originale del produttore
- Massimo max.: vedere la tabella nel capitolo "Imballaggio"
- Durata di conservazione: illimitata

3.2.4.4 Manutenzione - pulizia

- Affidare le operazioni di manutenzione e pulizia solo a personale qualificato
- I cuscinetti a sfera devono essere sostituiti dopo 20.000 ore di funzionamento in condizioni nominali (ad opera del costruttore).
- Controllare il rumore dei cuscinetti del motore ogni 2.500 ore di esercizio, ossia ogni anno. Se vengono rilevati rumori, occorre arrestare il funzionamento del motore e sostituire i cuscinetti (ad opera del costruttore).
- L'apertura del motore comporta l'estinzione della validità della garanzia.
- Se l'involucro è sporco, pulirlo con isopropanolo o simili, non immergere né nebulizzare

3.2.4.5 Riparazione e smaltimento

La riparazione del motore deve essere effettuata dal fabbricante. L'apertura del motore comporta l'estinzione della validità della garanzia. In conformità con gli orientamenti della Direttiva 2012/19/UE (RAEE), ritiriamo vecchi dispositivi ed accessori per eseguire uno smaltimento professionale; le spese di trasporto sono a carico del mittente. Inviare il motore a:

Kollmorgen s.r.o.

c.a. Repair Department

Evropska 864

664 42 Modrice / Repubblica Ceca

E-mail: brno_customer_repairs@kollmorgen.com

Telefono: +420 533 314 455

3.3 Imballaggio

3.3.1 Imballaggio per la consegna

- Motore della AKM2G serie
- Manuale del prodotto (multilingua) stampato, uno per ogni consegna

3.3.2 Targhetta di identificazione

Nei motori standard la targhetta è adesiva sul lato involucro.

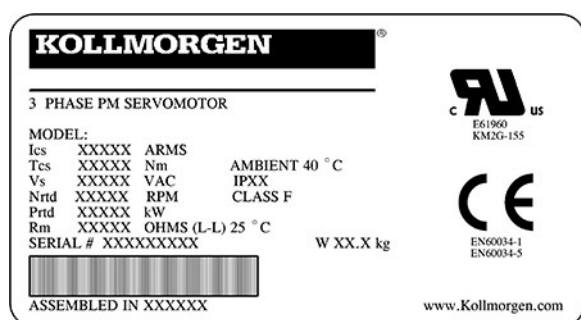
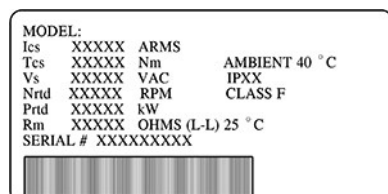

Legenda	Descrizione
MODELLO	tipo di motore
Ics	corrente di arresto
Tcs	coppia di stallo
Vs	U_N (tensione di alimentazione)
Nrtid	nn (velocità nominale a U_N)
Prtd	P_n (potenza nominale)
Rm	R25 (resistenza dell'avvolgimento a 25°)
PORTA	n. di serie
AMBIENT	temperatura ambiente max.
W	Peso motore in kg
IPXX	Valutazione protezione ingresso
CLASSE F	Valutazione isolamento

L'anno di fabbricazione è codificato nel numero di serie: le prime due cifre del numero di serie rappresentano l'anno di fabbricazione, ad es. "17" significa 2017.

3.3.3 Descrizione del numero di modello AKM2G

3.3.3.1 Schema dei codici articolo

Usare lo schema dei codici articolo solo per l'identificazione del prodotto e non per l'elaborazione dell'ordine, poiché non tutte le combinazioni teoriche delle funzioni sono possibili.

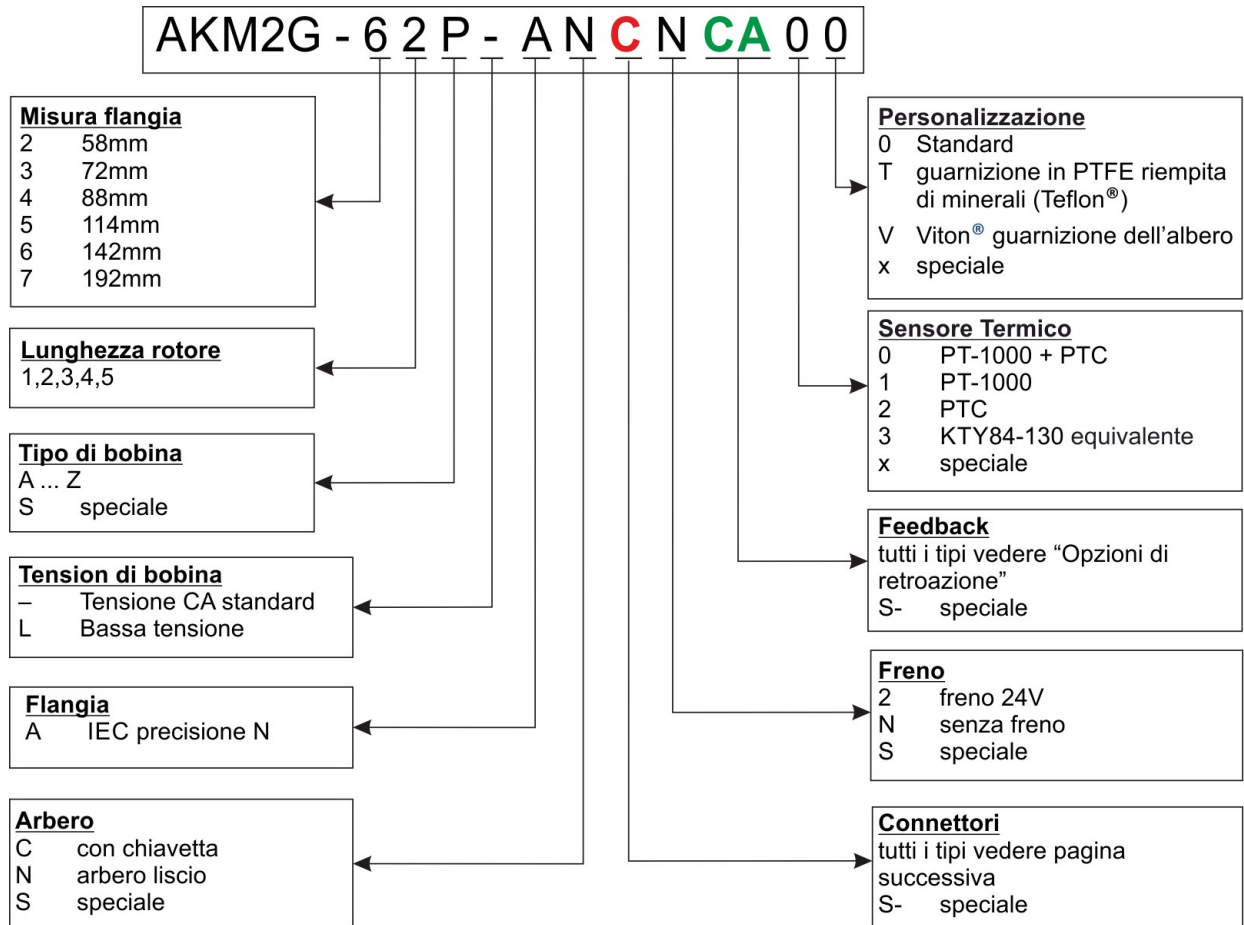

3.3.3.2 Opzioni connettore (C)

I collegamenti per le opzioni del connettore sono elencati nel capitolo "Collegamenti del connettore" da [Connector Pinout](#).

3.3.3.3.1 Descrizione dei connettori

Connettore	Uso*	Contatti - Pin	Max corrente [A]	Max sezione trasversale [mm ²]	Classe di protezione	Cavo alimentazione Dimensione conduttore (mm ²)	Connettore di accoppiamento consigliato
		Potenza/ Segnale	Potenza/ Segnale	Potenza/ Segnale			
Connettori ad angolo retto SpeedTec M23 (misura 1)	Potenza e freni	4 / 5	20 / 10	4 / 1,5	IP65	1,5	BSTA-082-FR-46-58-0100-000
						2,5	BSTA-082-FR-46-58-0100-000
						4,0	BSTA-082-FR-32-59-0100-000
	Resolver	- / 12	- / 10	- / 0,5	IP65	-	ASTA-013-FR-01-62-0100-000
	Encoder	- / 17	- / 10	- / 0,5	IP65	-	ASTA-014-FR-01-61-0100-000
	Ibrido (SFD3)	4 / 5	20 / 10	4 / 1,5	IP65	1,5	BSTA-082-FR-46-58-0100-000
						2,5	BSTA-082-FR-46-58-0100-000
						4,0	BSTA-082-FR-32-58-0100-000
	Ibrido (DSL)	4 / 5	20 / 10	4 / 1,5	IP65	1,5	H51A-425-FR-14-58-0100-000 + 40.A711.00
						2,5	H51A-425-FR-14-58-0100-000 + 40.A711.00
						4,0	H51A-425-FR-15-59-0100-000 + 40.A711.00
	Ibrido (EnDat)	4 / 5	20 / 10	4 / 1,5	IP65	1,5	H51A-405-FR-14-59-0100-000 + 40.A702.00
						4,0	H51A-405-FR-15-59-0100-000 + 40.A702.00

Connettore	Uso*	Contatti - Pin	Max corrente [A]	Max sezione trasversale [mm ²]	Classe di protezione	Cavo alimentazione Dimensione conduttore (mm ²)	Connettore di accoppiamento consigliato
		Potenza/ Segnale	Potenza/ Segnale	Potenza/ Segnale			
M40 (misura 1,5)	Potenza e freni	4 / 5	75 / 30	16 / 4	IP65	4,0	CSTA-265-FR-06-26-0020-000
						6,0	CSTA-265-FR-06-25-0020-000
						10,0	CSTA-265-FR-06-25-0020-000
	Ibrido (SFD3)	4 / 5	75 / 30	16 / 4	IP65	4,0	CSTA-265-FR-06-26-0020-000
						6,0	CSTA-265-FR-06-25-0020-000
						10,0	CSTA-265-FR-06-25-0020-000
	Ibrido (DSL)	4 / 5	75 / 30	16 / 4	IP65	4,0	H81A-501-FR-03-44-0100-000 + 40.A711.00
						6,0	H81A-501-FR-03-45-0100-000 + 40.A711.00
	y-tec	Potenza e freni	4 / 5	14 / 3,6	1,5 / 0,75	IP65	1,5
Retroazione		- / 12	- / 5	- / 0,75	IP65		ESTB-002-FR-02-32-0001-000

Ibrido (SFD3) significa: Potenza e retroazione SFD3 (più freno) sullo stesso connettore e in un unico cavo.

Ibrido (DSL) significa: Potenza e retroazione DSL (più freno) sullo stesso connettore e in un unico cavo.

Ibrido (EnDat) significa: Potenza e retroazione EnDat (più freno) sullo stesso connettore e in un unico cavo.

3.3.3.4.2 Sigla connettore - Motore

Sigla modello	Collegamento	Utilizzabile con	Posizione di collegamento
C	2 SpeedTec M23	AKM2G3 - AKM2G7 ≤ 20 Amp	Angolare, girevole, montato su motore
D*	1 ibrido M23	AKM2G2 - AKM2G7 ≤ 20 Amp	Angolare, girevole, montato su motore
G	2 SpeedTec M23	AKM2G3 - AKM2G7 ≤ 20 Amp	Dritto, montato su motore
A	1 M40 alimentazione, 1 M23 retroazione	AKM2G7 > 20 Amp	Angolare, girevole, montato su motore
J*	1 connettore ibrido M40	AKM2G7 > 20 Amp	Angolare, girevole, montato su motore
Y	1 connettore Y-Tec	AKM2G2	Girevole, montato su motore

* Connettori ibridi validi solo per SFD3, DSL e EnDat.

3.3.3.5 Opzioni di retroazione (CA)

La lunghezza del motore dipende dal dispositivo di retroazione integrato, vedere schemi delle dimensioni in [Dimension drawings](#).

Non è possibile il riadattamento. Per le opzioni del connettore sono elencati i collegamenti [Connector Pinout](#).

3.3.3.6.1 Descrizione della retroazione

Codice	Descrizione	Supporto motore ID 3	Precisione 1,2 (secondi d'arco)	Rumore RMS 1 (secondi d'arco)	Commenti	Risoluzione	Giri assoluti	Azionamenti compatibili	Supporto sicurezza funzionale 4
CA	SFD3	Sì	±585"	±9,9"	Induttivo	24 bit	1	Famiglia AKD	No
GU	Hiperface DSL	Sì	±240"	±20"	Capacitivo	17 bit	4096	Famiglia AKD	fino a SIL2 7,9
LD 5	EnDat 2.2	Sì	±120"	Vedere Nota 6 sotto	Induttivo	19 bit	4096	Famiglia AKD	fino a SIL310
			±65"						
R-	Resolver	No	±540"	N/D	Induttivo	24 bit per AKD	1	Tutti	No
2- 8	Encoder a commutazione	No	+/-218,2"	N/D	Ottico	12 bit	nessuno	Famiglia AKD	

1. Gli azionamenti AKD hanno una precisione di misurazione del resolver di ±45", per un azionamento con precisione motore di ±585" e rumore RMS pari a ±9,9".
2. La precisione si riferisce alla precisione del sistema complessivo una volta installato nel motore. Il rumore si riferisce al rumore di posizione RMS quando è "fermo".
3. Supporto ID motore significa che la targhetta del motore elettronico è compresa e consente la messa in servizio plug and play.
4. Valutazione SIL del dispositivo quale fornita dal produttore della retroazione. Al cliente incombe la responsabilità della valutazione della sicurezza funzionale della macchina.
5. Per i motori con retroazione EnDat, l'accelerazione del motore è limitata a $\leq 1 \cdot 10^5$ rad/s². Il servoazionamento collegato può limitare ulteriormente tale valore.
6. Informazione non disponibile al momento della stampa. Contattare Kollmorgen il servizio clienti per l'ultimo aggiornamento.
7. Per motori con numero di serie 1935100001 o successivo.
8. Disponibile solo su motori a bassa tensione AKM2G3 e superiori.
9. Consultare il sito del produttore (link sotto) per informazioni dettagliate relative alle specifiche di sicurezza funzionale della retroazione in oggetto. La sezione "Parametri correlati alla sicurezza" contiene informazioni specifiche sulle caratteristiche di sicurezza del prodotto. Altre sezioni forniscono ulteriori dettagli.
www.sick.com/us/en/motor-feedback-systems/motor-feedback-systems-rotary-hiperface-dsl/eeseem37/eem37-2kf0a017a/p/p486170
 Le informazioni del sito e i link sono quelli disponibili alla data di pubblicazione del presente manuale. In alternativa, effettuare una ricerca sul sito per prodotto #1067125.
10. Per informazioni dettagliate relative alle specifiche di sicurezza funzionale della retroazione in oggetto consultare il sito del produttore indicato in appresso.
www.heidenhain.com/en_US/products/rotary-encoders/without-integral-bearing/
 In questa pagina, selezionare l'attuale link del documento per la retroazione utilizzata con AKM2G.

AKM2G dimensioni	Modello produttore #	Informazioni generali sulla sicurezza	Informazioni specifiche sul modello
Dimensioni telaio 2-4	EQI 1131	pagine 28-29	pagine 72-75
Dimensioni telaio 5-7	EQI 1331	pagine 28-29	pagine 78-79

Le informazioni del sito e i link sono quelli disponibili alla data di pubblicazione del presente manuale. In alternativa, effettuare una ricerca sul sito per numero di modello (vedi sopra).

3.3.3.7.2 Opzioni connettore disponibili dalla gamma di retroazioni

SFD3

Tipo connettore	Compatibile AKM2Gx	Tipo
P	AKM2G2-4	Misura 15
P	AKM2G5-7 ≤ 20A	Misura 21
J	AKM2G7 > 20A	Misura 21

Hiperface DSL

Tipo connettore	Compatibile AKM2Gx	Tipo
P	AKM2G2-7 ≤ 20A	EEM37
J	AKM2G7 > 20A	EEM37

EnDat 2.2

Tipo connettore	Compatibile AKM2Gx	Tipo
P	AKM2G2-4	EQI 1131
P	AKM2G5-7 ≤ 20A	EQI 1331

Resolver

Tipo connettore	Compatibile AKM2Gx	Tipo
Y	AKM2G2	Misura 15
C / G	AKM2G3-4	Misura 15
C / G	AKM2G5-7 ≤ 20A	Misura 21
A	AKM2G7 > 20A	Misura 21

Encoder a commutazione

Tipo connettore	Compatibile AKM2Gx	Tipo
C / G	AKM2G3-4	Misura 15

3.4 Descrizione tecnica

3.4.1 Dati tecnici generali

Temperatura ambiente (a valori nominali)	Da 5 a +40 °C per un'altitudine del sito fino a 1000 m slm È importante consultare il nostro reparto di applicazioni per temperature ambiente superiori a 40 °C e il montaggio incapsulato dei motori.
Umidità ammessa (a valori nominali)	95% di umidità relativa, senza formazione di condensa
Riduzione di potenza (correnti e coppie)	1%/K nell'intervallo da 40 °C a 50 °C fino a 1000 m slm per un'altitudine del sito superiore a 1000 m slm e 40 °C 6% fino a 2000 m slm 17% fino a 3000 m slm 30% fino a 4000 m slm 55% fino a 5000 m slm Nessuna riduzione della potenza per altitudini del sito oltre 1000 m slm con riduzione della temperatura di 10K / 1000 m
Durata dei cuscinetti a sfera	≥ 20.000 ore di esercizio

NOTE

I dati tecnici per ogni tipo di motore sono disponibili nel capitolo "Dati tecnici" da [Technical Data](#).

3.4.2 Caratteristiche standard

3.4.2.1 Tipo

Il tipo di base per i motori AKM2G è IM B5 secondo EN 60034-7.

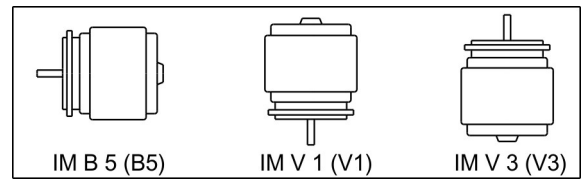

3.4.2.2 Flangia

Precisione della flangia IEC secondo DIN 42955. Tolleranze di fuoriuscita dell'estensione dell'albero e di flange di montaggio per macchine elettriche rotanti.

Codice	Flangia
Un sistema	IEC con precisione N, montare AKM2G2-7: j6

3.4.2.3 Classe di protezione

Secondo EN 60529.

Motore standard	Opzione connettore	Guarnizione albero	Classe di protezione
AKM2G2-AKM2G7	C, D, G, H, J, Y	senza	IP54
AKM2G2-AKM2G7	C, D, G, H, J, Y	con	IP65

3.4.2.4 Classe del materiale isolante

I motori sono forniti con materiale isolante di classe F secondo IEC 60085 (UL1446 classe F).

3.4.2.5 Superficie

I motori sono rivestiti con e poliesteri nero opaco. Questa finitura non è resistente ai solventi (ad es. tricloroetilene, diluenti nitro o simili).

3.4.2.6 Estremità azionamento, lato A

La trasmissione di potenza è realizzata attraverso l'estremità dell'albero A, montaggio k6 secondo EN 50347 con filettatura di serraggio ma **senza una sede della chiavetta**.

I motori sono disponibili anche con la sede della chiavetta e la chiave inserita secondo DIN 6885. L'albero con la sede della chiavetta è bilanciato con una chiavetta corta (metà).

La durata dei cuscinetti è calcolata in 20.000 ore di esercizio.

Codice per ordinazione	Estremità dell'albero	Disponibile per
N	Albero liscio	AKM2G 2-7
C	Sede della chiavetta, chiusa	AKM2G 2-7

Forza radiale

Se l'azionamento dei motori avviene tramite pignoni o cinghie dentate, si generano forze radiali elevate. I valori ammissibili all'estremità dell'albero sono consultabili negli schemi nel capitolo "Disegni" da [Dimension drawings](#). I valori massimi alla velocità nominale sono disponibili nei dati tecnici da [Technical Data](#). La presa di forza dal centro dell'estremità libera dell'albero permette un aumento del 10% in F_R .

Forza assiale

Durante il montaggio di pignoni o ruote all'asse e, ad esempio, l'uso di riduttori angolari, si generano forze assiali. I valori massimi alla velocità nominale sono disponibili nei dati tecnici.

Accoppiamento

Gli anelli di serraggio a doppio cono si sono rivelati la soluzione ideale per dispositivi di accoppiamento senza gioco, in combinazione, se necessario, con accoppiamenti a soffietto in metallo. Foro del centro dell'albero per DIN 332 formato D.

3.4.2.7 Guarnizione dell'albero

Se AKM2G è collegato a una flangia della macchina con una regione dell'albero non sigillata, la guarnizione dell'albero (opzione "T" o "V") garantisce la tenuta dell'albero.

- L'opzione "T" è costituita da una guarnizione di PTFE riempita di minerale (Teflon®) autolubrificante ed è raccomandata per le applicazioni in cui non è possibile una lubrificazione regolare della guarnizione dell'albero.
- L'opzione "V" è costituita da Viton® ed è raccomandata per le applicazioni in cui è prevista la lubrificazione regolare della guarnizione dell'albero, come nel caso dei riduttori lubrificati.
- La guarnizione dell'albero garantisce la protezione IP65 per la zona dell'albero.
- Il rendimento nominale viene raggiunto dopo alcune ore di rodaggio della guarnizione dell'albero. Non è necessaria alcuna procedura speciale per il rodaggio.
- Una certa "perdita" del materiale della guarnizione dell'albero, soprattutto di Teflon®, è normale e non ne influenza il funzionamento.
- La guarnizione dell'albero è pre-lubrificata con grasso.

3.4.2.8 Dispositivo di protezione

La versione standard a tensione CA di ogni motore è dotata di un sensore di temperatura PT-1000+ PTC con isolamento elettrico. La versione a bassa tensione di ogni motore è dotata di un sensore di temperatura PT-1000 con isolamento elettrico. I sensori termici non forniscono alcuna protezione contro un breve sovraccarico intenso.

Il motore può essere dotato, in opzione, di sensori equivalenti PT-1000 +PTC, PT-1000, PTC, o KTY 84-130 (vedere [Opzioni dispositivo termico: grafici di resistenza rispetto a temperatura 0, 1, 2, e 3](#)).

Lo stato del sensore di temperatura viene trasmesso in digitale e valutato nell'azionamento grazie ai sistemi di retroazione digitale SFD3 (CA), Hiperface DSL (GU) e EnDat 2.2 (LD).

A condizione che vengano utilizzati i nostri cavi di retroazione configurati, il sensore è integrato nel sistema di monitoraggio dei servoamplificatori digitali.

3.4.2.9.1 Opzioni dispositivo termico: grafici di resistenza rispetto a temperatura

Le curve delle opzioni dispositivo termico indicano la resistenza equivalente in ohm che corrisponde a una data temperatura degli avvolgimenti del motore. L'azionamento usato con il motore deve sostenere il dispositivo termico selezionato ai fini di un funzionamento corretto.

Dispositivo termico, opzione 0

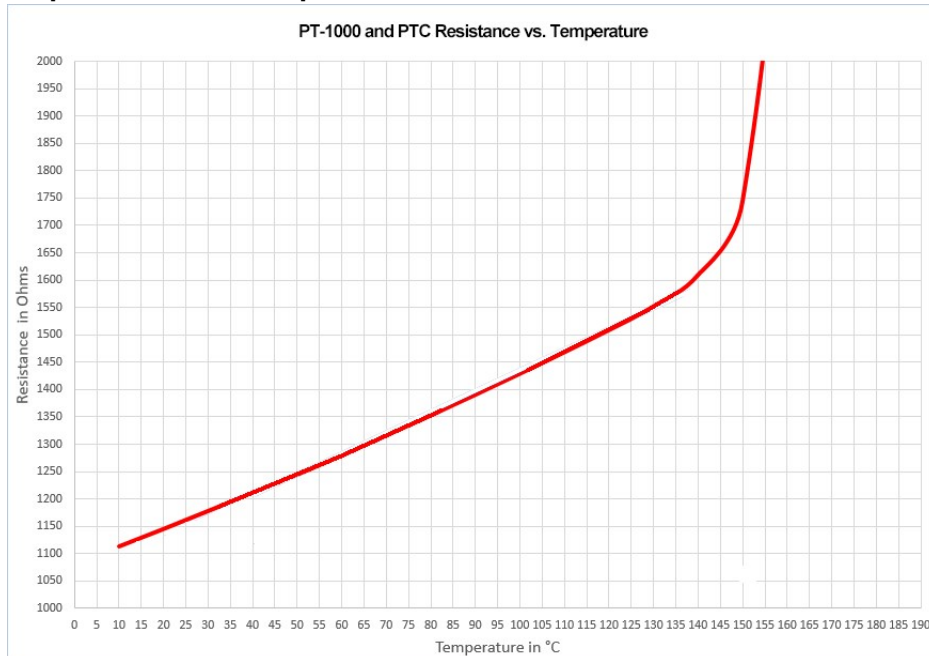

Dispositivo termico, opzione 1

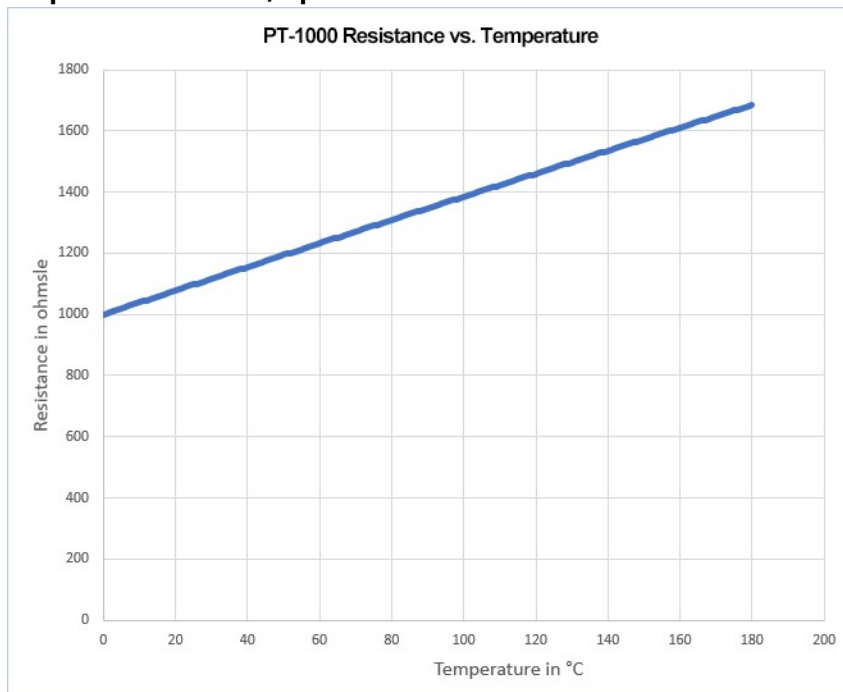

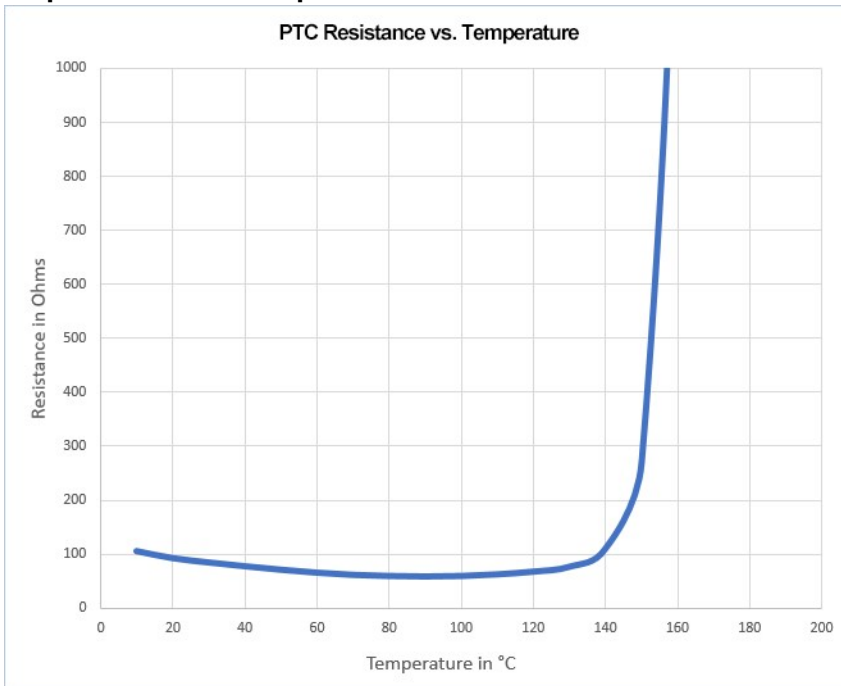
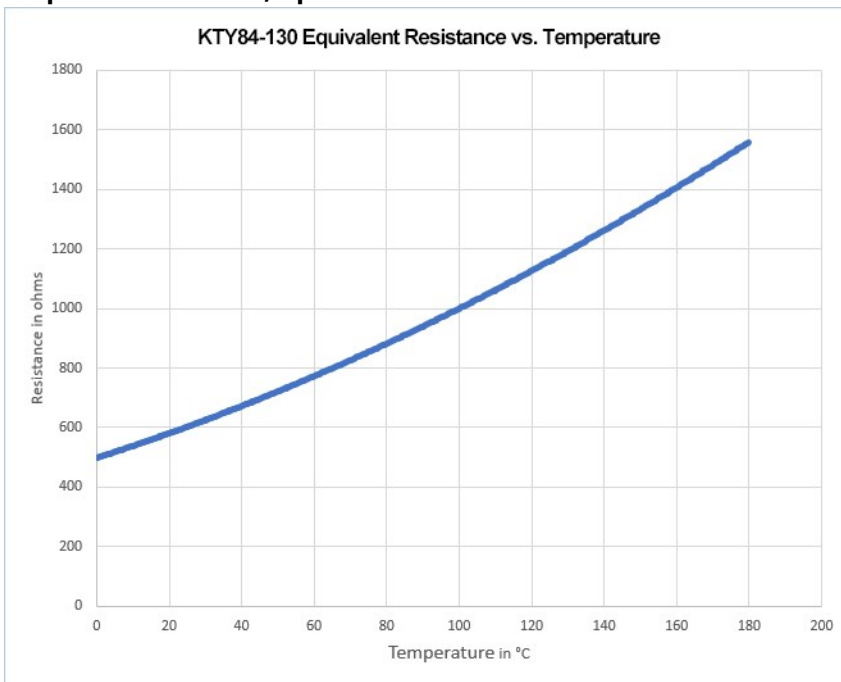
Dispositivo termico, opzione 2**Dispositivo termico, opzione 3****3.4.2.10 Classe di vibrazione**

I motori sono realizzati secondo il grado di vibrazione A di EN 60034-14. Per un intervallo di velocità di 600-3600 giri/min e un centro dell'albero tra 56-132 mm, il valore effettivo della gravità della vibrazione permessa è di 1,6 mm/s.

Velocità [giri/min]	Max. umidità Spostamento per vibrazione [µm]	Max. Fuoriuscita del [µm]
<= 1800	90	23
> 1800	65	16

3.4.3 Tecnologia di cablaggio

3.4.3.1 Connettori

Descrizioni dei connettori disponibili: [Opzioni connettore \(C\)](#). Collegamenti connettori: da [Connector Pinout](#).

3.4.3.2 Sezioni trasversali dei cavi

(Sezioni trasversali dei cavi per temp. ambiente 40 °C)

Cavo di alimentazione, cavo Combi

I cavi Combi contengono 4 linee di alimentazione e 2 altre linee per il controllo del freno di stazionamento del motore.

Sezione trasversale		Portata di corrente	Commenti
Cavo	Cavo Combi		
(4x1)	(4x1+(2x0,75))	$0A < I_{0rms} \leq 10,1A$	Le parentesi (...) mostrano la schermatura. Portata di corrente secondo EN60204-1:2006 Tabella 6, colonna B2
(4x1,5)	(4x1,5+(2x0,75))	$10,1A < I_{0rms} \leq 13,1A$	
(4x2,5)	(4x2,5+(2x1))	$13,1A < I_{0rms} \leq 17,4A$	
(4x4)	(4x4+(2x1))	$17,4A < I_{0rms} \leq 23A$	
(4x6)	(4x6+(2x1))	$23A < I_{0rms} \leq 30A$	
(4x10)	(4x10+(2x1,5))	$30A < I_{0rms} \leq 40A$	
(4x16)	(4x16+(2x1,5))	$40A < I_{0rms} \leq 54A$	
(4x25)	(4x25+(2x1,5))	$54A < I_{0rms} \leq 70A$	

Cavo di retroazione

Tipo	Sezione trasversale	Commenti
Resolver	(4x2x0,25)	
Encoder	(4x2x0,25)	

Cavo ibrido

Tipo	Sezione trasversale	Commenti
SFD3/DSL	(4x1,0+(2x0,34)+(2x0,75))	4 linee di alimentazione e 2 linee del freno e 2 linee di segnale per SFD3/DSL 6 linee di segnale per EnDat 2.2
SFD3/DSL	(4x1,5+(2x0,34)+(2x0,75))	
SFD3/DSL	(4x2,5+(2x0,34)+(2x1,0))	
SFD3/DSL	(4x4,0+(2x0,34)+(2x1,0))	
SFD3/DSL	(4x2,5+(2x0,34)+(2x1,0))	
EnDat 2.2	(4x1,5 + (2x0,75) + (2x (2x0,14) + (2x0,25)))	
EnDat 2.2	(4x4,0 + (2x1,0) + (2x (2x0,14) + (2x0,25)))	

3.4.4 Freno di stazionamento

Tutti i motori sono disponibili opzionalmente con un freno di stazionamento. Un freno a molla (24 V DC) è integrato nei motori. Quando questo freno viene diseccitato, blocca il rotore.



AVVISO

Se è presente un carico sospeso (assi verticali), il freno di stazionamento del motore è rilasciato e, allo stesso tempo, il servoazionamento non produce potenza in uscita, il carico potrebbe cadere! Rischio di lesioni per il personale addetto al funzionamento della macchina. L'utente deve rispettare le norme locali in materia di sicurezza applicabili in caso di carichi sospesi (assi verticali) e l'esigenza di garantire la sicurezza del personale adottando opportune misure per evitare il pericolo.

NOTICE

I freni di stazionamento sono progettati per lo stazionamento e non sono adatti per la frenata operativa ripetuta. Frenate operative frequenti possono determinare l'usura prematura e un guasto del freno di stazionamento.

La lunghezza del motore aumenta quando è montato un freno di stazionamento.

Il freno di stazionamento può essere controllato direttamente tramite il servoamplificatore (non vi è alcuna sicurezza per le persone!), l'avvolgimento nel servoamplificatore viene eliminato - non è necessaria circuiteria aggiuntiva (vedere il manuale di istruzioni del servoamplificatore). Se il freno di stazionamento non è controllato direttamente dal servoazionamento, è necessario un cablaggio aggiuntivo (ad esempio un varistore). Consultare il nostro reparto di assistenza.

I dati relativi ai freni sono elencati nel capitolo "Dati tecnici dei freni" in [Technical Data Brakes](#).

3.5 Installazione meccanica

NOTE

I disegni quotati sono disponibili nel capitolo "[Dimension drawings](#)".

3.5.1 Note importanti

NOTE

Solo il personale qualificato esperto in meccanica è autorizzato ad assemblare il motore.

- Proteggere il motore da sollecitazioni non consentite. Durante il trasporto e la movimentazione i componenti non devono essere danneggiati.
- Sul sito non devono essere presenti materiali conduttivi o aggressivi. Per il montaggio V3 (estremità dell'albero verso l'alto), assicurarsi che nessun liquido possa entrare nei cuscinetti.
- Garantire una ventilazione libera e senza ostacoli dei motori e rispettare le temperature consentite per ambiente e flange. Per temperature ambiente superiori a 40 °C, consultare preventivamente il nostro reparto applicazioni. Assicurarsi che vi sia un adeguato scambio termico nell'ambiente circostante e sulla flangia del motore.
- L'albero e la flangia del motore sono particolarmente vulnerabili nelle fasi di conservazione e assemblaggio, quindi occorre adottare la dovuta cautela. È importante utilizzare la filettatura di bloccaggio fornita per serrare giunti, ruote dentate o pulegge e riscaldare i componenti di azionamento, ove possibile. Eventuali urti o l'applicazione di forze possono danneggiare i cuscinetti e l'albero.

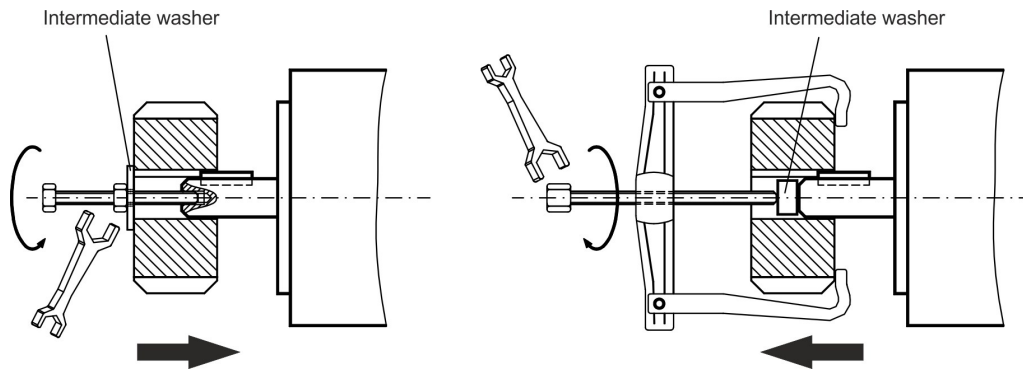

- Ove possibile, utilizzare unicamente anelli di serraggio o giunti ad attrito senza gioco. Verificare il corretto allineamento dei giunti. Uno spostamento può provocare il verificarsi di vibrazioni non consentite nonché la distruzione dei cuscinetti e del giunto.
- In ogni caso, è opportuno non realizzare un albero motore vincolato meccanicamente montando un accoppiamento rigido con cuscinetti esterni aggiuntivi (ad esempio in un riduttore).
- Prendere nota del numero di poli del motore e del resolver (se presente) e verificare che sia applicata la corretta impostazione nel servoamplificatore che viene utilizzato. Una impostazione errata può portare alla distruzione del motore, in particolare con motori piccoli.
- Evitare, per quanto possibile, carichi assiali sull'albero motore. Il carico assiale riduce significativamente la durata del motore.
- Verificare la conformità alle forze radiali e assiali tollerate F_R e $F_{Un sistema}$. Quando si utilizza una trasmissione a cinghia dentata, il diametro minimo consentito del pignone deriva ad esempio dall'equazione: $d_{min} \geq (M_0/F_R)*2$

3.6 Installazione elettrica

NOTE

I collegamenti per il connettore sono reperibili nel capitolo "Collegamenti del connettore" in [Connector Pinout](#). I collegamenti dell'estremità del servo-amplificatore sono disponibili nel manuale di istruzioni del servoamplificatore.

3.6.1 Note importanti

NOTE

Affidare l'esecuzione del cablaggio del motore unicamente a personale qualificato e adeguatamente formato in elettrotecnica.



PERICOLO

Verificare sempre che i motori siano diseccitati durante le fasi di assemblaggio e di cablaggio, cioè che la tensione non possa essere attivata in alcun apparecchio da collegare.



Toccare i contatti esposti comporta un pericolo di morte o di lesioni gravi. Assicurarsi che l'armadio elettrico rimanga spento (barriera, cartelli di avvertimento, ecc.). Le singole tensioni potranno essere attivate nuovamente solo durante la procedura di configurazione.

Non staccare mai i collegamenti elettrici dal servoamplificatore quando quest'ultimo è sotto tensione. Rischio di scosse elettriche! In condizioni sfavorevoli possono verificarsi archi elettrici che possono causare lesioni alle persone e danneggiare i contatti.

Sui condensatori può persistere una tensione pericolosa risultante dalla carica residua, fino a 10 minuti dopo l'interruzione dell'alimentazione di rete. Anche quando il motore non gira, i cavi di controllo e di alimentazione possono essere sotto tensione.

Misurare la tensione DC-link o e attendere che la tensione sia scesa sotto i 60V.

NOTE

Il simbolo di terra,  che si trova negli schemi di collegamento, indica che occorre realizzare un collegamento elettrico con una superficie più ampia possibile tra l'unità indicata e la piastra di montaggio nell'armadio elettrico. Questo collegamento serve a eliminare le interferenze HF e non deve essere confuso con il simbolo PE (messa a terra di protezione)  (misura protettiva secondo EN 60204).

Per collegare il cablaggio del motore, utilizzare gli schemi elettrici nelle istruzioni di installazione e configurazione del servoamplificatore che viene utilizzato.

3.6.2 Guida all'installazione elettrica

- Verificare che il servoamplificatore e il motore siano combinati correttamente. Confrontare la tensione e la corrente nominali dell'unità. Effettuare il cablaggio in base allo schema elettrico nel manuale di istruzioni del servoamplificatore. I collegamenti del motore sono illustrati nel capitolo "Collegamenti dei connettori" in [Connector Pinout](#).
- Installare cavi che conducono corrente elevata e presentano una sezione adeguata, secondo la norma EN 60204. La sezione consigliata è disponibile nei Dati tecnici.

NOTE

In caso di cavi del motore lunghi (> 25 m) e a seconda del tipo di servoamplificatore usato, commutare un'induttanza per motore nel cavo del motore (vedere il manuale di istruzioni del servoamplificatore e il manuale degli accessori).

- Verificare la presenza di una messa a terra corretta per il servoamplificatore e il motore. Utilizzare la corretta messa a terra e schermatura EMC secondo il manuale di istruzioni del rispettivo servoamplificatore utilizzato. Mettere a terra la piastra di montaggio e l'involucro del motore.
- Se si usa un cavo di alimentazione del motore che include i cavi di comando del freno integrati, tali cavi devono essere schermati. La schermatura deve essere collegata ad entrambe le estremità (vedere il manuale di istruzioni del servoamplificatore).
- Cablaggio:
 - Posizionare i cavi di alimentazione il più possibile separati dai cavi di comando
 - Collegare il dispositivo di retroazione.
 - Collegare i cavi del motore e installare l'induttanza per motore (se presente) vicino all'amplificatore
 - Collegare le schermature ai terminali di schermatura o ai connettori EMC a entrambe le estremità
 - Collegare il freno di stazionamento, se utilizzato
 - Collegare la schermatura a entrambe le estremità.
- Collegare tutte le schermature tramite un'ampia zona di contatto (a bassa impedenza) e alloggiamenti dei connettori metallizzati o pressacavi EMC.
- Requisiti del materiale dei cavi:

Capacitanza

Cavo del motore: inferiore a 150 pF/metro

Cavo di retroazione: inferiore a 120 pF/metro

3.6.3 Collegamento dei motori con cavi preassemblati

- Effettuare il cablaggio in conformità con le norme e i regolamenti in vigore.
- Usare solo Kollmorgen cavi schermati preassemblati per i collegamenti di alimentazione e retroazione.
- La schermatura non installata correttamente provoca interferenze EMC e influisce negativamente sul funzionamento del sistema.
- La lunghezza massima del cavo è definita nel manuale di istruzioni del servoamplificatore utilizzato.

NOTE

Per una descrizione dettagliata dei cavi configurati, consultare il manuale regionale accessori.

3.7 Configurazione

3.7.1 Note importanti

NOTE

Solo personale specializzato esperto in elettrotecnica e nelle tecnologie di azionamento può eseguire la messa in funzione del servoamplificatore e del motore.



PERICOLO

Possono essere generate tensioni mortali fino a 900 V. Rischio di scosse elettriche! Verificare che tutti i punti di collegamento sotto tensione siano protetti dal contatto accidentale.

Non staccare mai i collegamenti elettrici al motore quando quest'ultimo è sotto tensione. Rischio di scosse elettriche! La carica residua nei condensatori dell'azionamento può produrre tensioni pericolose fino a 10 minuti dopo l'interruzione dell'alimentazione di rete.

Anche quando il motore non gira, i cavi di controllo e di alimentazione possono essere sotto tensione. Misurare la tensione DC-link o e attendere che la tensione sia scesa sotto i 60 V.



ATTENZIONE

La temperatura superficiale del motore può superare i 100 °C durante il funzionamento. Pericolo di ustioni lievi! Controllare (misurare) la temperatura del motore e attendere che il motore scenda al di sotto di 40 °C prima di toccarlo.



ATTENZIONE

Durante la messa in funzione l'azionamento esegue movimenti imprevisti, che non possono essere controllati.

Assicurarsi che, se l'azionamento inizia a spostarsi in modo imprevisto, non sussistano pericoli per il personale o per i macchinari.

Le misure da adottare in proposito si basano sulla valutazione dei rischi dell'applicazione.

3.7.2 Guida alla configurazione

La procedura di configurazione è descritta a titolo esemplificativo. Può essere appropriato o necessario un metodo diverso, a seconda dell'applicazione delle apparecchiature.

1. Verificare il montaggio e l'orientamento del motore.
2. Controllare il corretto posizionamento e la regolazione (osservare le forze radiali e assiali tollerabili) dei componenti dell'azionamento (frizione, riduttore, puleggia).
3. Controllare il cablaggio e i collegamenti al motore e al servoamplificatore. Controllare che la messa a terra sia corretta.
4. Verificare il funzionamento del freno di stazionamento, se utilizzato. (Applicare 24 V, il freno deve essere rilasciato).
5. Verificare che il rotore del motore giri liberamente (rilasciare il freno, se necessario). Verificare che non vi siano rumori anomali.
6. Controllare che siano state adottate tutte le misure necessarie ad evitare il contatto accidentale con parti in movimento e sotto tensione.
7. Effettuare ulteriori test specificatamente richiesti per il sistema in questione.
8. Ora è possibile mettere in funzione l'azionamento secondo le istruzioni di configurazione del servoamplificatore.
9. In sistemi multiasse, mettere singolarmente in funzione ciascuna unità di azionamento (amplificatore e motore).

3.7.3 Risoluzione dei problemi

La tabella seguente dovrebbe essere considerata come una cassetta di "primo soccorso". Un guasto può essere determinato da diverse cause, a seconda delle condizioni particolari dell'impianto specifico. Di seguito sono descritte le cause che maggiormente influenzano direttamente il motore. Le anomalie che si manifestano nel comportamento del circuito di controllo possono essere solitamente ricondotte a un errore di parametrizzazione del servoamplificatore. La documentazione relativa al servoamplificatore e al software di configurazione fornisce informazioni utili su tali questioni.

Per sistemi multiasse i guasti possono essere dovuti a altre cause nascoste.

Guasto	Causa possibile	Misure per eliminare la causa del guasto
Il motore non gira	<ul style="list-style-type: none"> - Servoamplificatore non abilitato - Rottura del cavo di setpoint - Fasi motore in sequenza errata - Freno non rilasciato - Azionamento bloccato meccanicamente 	<ul style="list-style-type: none"> - Applicare il segnale di abilitazione - Controllare il cavo di setpoint - Correggere la sequenza delle fasi - Controllare i comandi del freno - Controllare il meccanismo
Il motore è fuori controllo	<ul style="list-style-type: none"> - Fasi motore in sequenza errata 	<ul style="list-style-type: none"> - Correggere la sequenza delle fasi
Il motore oscilla	<ul style="list-style-type: none"> - Schermatura del cavo del retroazione rotta - Guadagno eccessivo dell'amplificatore 	<ul style="list-style-type: none"> - Sostituire il cavo di retroazione - Applicare i valori predefiniti del motore
Messaggio d'errore: freno	<ul style="list-style-type: none"> - Cortocircuito nella tensione di alimentazione al freno di stazionamento del motore - Freno di stazionamento del motore guasto 	<ul style="list-style-type: none"> - Eliminare il cortocircuito - Sostituire il motore
Messaggio d'errore: guasto dello stadio d'uscita	<ul style="list-style-type: none"> - Cortocircuito del cavo del motore o di terra - Cortocircuito del motore o di terra 	<ul style="list-style-type: none"> - Sostituire il cavo - Sostituire il motore
Messaggio d'errore: retroazione	<ul style="list-style-type: none"> - Connettore di retroazione non inserito correttamente - Cavo di retroazione rotto, cavo schiacciato o altro 	<ul style="list-style-type: none"> - Controllare il connettore - Controllare i cavi
Messaggio d'errore: temperatura del motore	<ul style="list-style-type: none"> - Termosensore del motore commutato - Connettore di retroazione allentato o cavo di retroazione rotto 	<ul style="list-style-type: none"> - Attendere finché il motore non si è raffreddato. In seguito, indagare il motivo per cui il motore si surriscalda in questo modo. - Controllare il connettore, sostituire il cavo di retroazione se necessario
Il freno non fa presa	<ul style="list-style-type: none"> - Coppia di stallo richiesta eccessiva - Freno guasto - Albero motore sovraccaricato assialmente 	<ul style="list-style-type: none"> - Controllare il dimensionamento - Sostituire il motore - Controllare il carico assiale e ridurlo. Sostituire il motore, i cuscinetti sono stati danneggiati

3.8 Definizione dei termini per i dati tecnici

NOTE

I dati tecnici per ogni tipo di motore sono reperibili nel capitolo "Dati tecnici" [Technical Data](#).

Tutti i dati validi per 40 °C di temperatura ambiente e 100K di sovratemperatura dell'avvolgimento. Determinazione dei dati nominali con temperatura costante della flangia dell'adattatore di 65 °C. I dati possono avere una tolleranza del +/- 10%.

Coppia di arresto M_0 [Nm]

La coppia di arresto può essere mantenuta per un tempo indefinito a una velocità di $0 < n < 100$ giri/min e in condizioni ambientali nominali.

Coppia nominale M_n [Nm]

La coppia nominale è prodotta quando il motore assorbe la corrente nominale alla velocità nominale. La coppia nominale può essere prodotta per un tempo indefinito alla velocità nominale in funzionamento continuo (S1).

Corrente di arresto I_{0rms} [A]

La corrente di arresto è la corrente sinusoidale effettiva che il motore assorbe a $0 < n < 100$ giri/min per produrre la coppia di arresto.

Corrente di picco (corrente a impulsi) $_{0max}$ [A]

La corrente di picco (valore sinusoidale effettivo) è pari a diverse volte la corrente nominale, a seconda dell'avvolgimento del motore. Il valore effettivo viene determinato dalla corrente di picco dell'azionamento utilizzato.

Costante di coppia K_{Trms} [Nm/A]

La costante di coppia definisce la quantità di coppia in Nm che è prodotta dal motore con una corrente 1 A rms. Il rapporto è $M = I \times K_T$.

Costante tensione K_{Erms} [mV/min-1]

La costante di tensione definisce la forza elettromotrice (EMF) indotta del motore, come un valore sinusoidale effettivo tra due morsetti, per 1.000 giri/min. Misurata a 25 °C.

Momento di inerzia del rotore J [kgcm²]

La costante J è una misura della capacità di accelerazione del motore. Ad esempio, a I_0 il tempo di accelerazione t_b da 0 a 3000 giri/min è dato da:

$$t_b [s] = \frac{3000 \cdot 2\pi}{M_0 \cdot 60s} \cdot \frac{m^2}{10^4 \cdot cm^2} \cdot J \quad \text{con } M_0 \text{ in Nm e } J \text{ in kgcm}^2$$

Costante di tempo termica t_{th} [min]

La costante t_{th} definisce il tempo impiegato dal motore a freddo, sotto un carico I_0 , per riscaldarsi fino a una sovratemperatura di $0,63 \times 105$ Kelvin. Questo aumento di temperatura avviene in un tempo molto più breve quando il motore è carico con la corrente di picco.

Tempo di ritardo del rilascio t_{BRH} [ms] / Tempo di ritardo nell'applicazione t_{BRL} [ms] del freno

Queste costanti definiscono i tempi di risposta del freno di stazionamento quando viene azionato con la tensione nominale dal servo-amplificatore.

U_N

Tensione di rete nominale

U_n

Tensione del bus DC-link. $U_n = \sqrt{2} \cdot U_N$

--- / ---

4 Español

4.1 General	86
4.1.1 Acerca de este manual	86
4.1.2 Abreviaturas usadas	86
4.1.3 Símbolos usados	86
4.2 de Seguridad	87
4.2.1 Debería prestar atención a las siguientes indicaciones	87
4.2.2 Uso correcto	89
4.2.3 Uso prohibido	89
4.2.4 Manipulación	90
4.3 Paquete	92
4.3.1 Paquete de entrega	92
4.3.2 Placa de identificación	92
4.3.3 Descripción de los números de modelo AKM2G	93
4.4 Descripción técnica	99
4.4.1 Datos técnicos generales	99
4.4.2 Características estándares	100
4.4.3 Tecnología de cableado	104
4.4.4 Freno de retención	105
4.5 Instalación mecánica	106
4.5.1 Notas importantes	106
4.6 Instalación eléctrica	107
4.6.1 Notas importantes	107
4.6.2 Guía de instalación eléctrica	108
4.6.3 Conexión de los motores con cables premontados	108
4.7 Puesta en funcionamiento	109
4.7.1 Notas importantes	109
4.7.2 Guía de puesta en funcionamiento	110
4.7.3 Resolución de problemas	111
4.8 Definición de los términos de Datos técnicos	113

4.1 General

4.1.1 Acerca de este manual

Este manual describe la serie AKM@2G de servomotores síncronos (versiones estándar/baja tensión). Los motores funcionan en sistemas de accionamiento junto con servoamplificadores Kollmorgen . Eche un vistazo a toda la documentación del sistema, compuesta de:

- Manual de instrucciones del servoamplificador
- Manual de comunicación de bus (p. ej., CANopen o EtherCAT)
- Ayuda en línea del software de configuración del amplificador
- Manual de accesorios regionales
- Descripción técnica de la serie AKM2G de motores







Puede encontrar más información en la Red de desarrolladores de Kollmorgen , disponible en kdn.kollmorgen.com permitidas.

4.1.2 Abreviaturas usadas

NOTE

Puede consultar las abreviaturas usadas para los datos técnicos en el capítulo "Definición de términos" → p. 113 permitidas.
En este documento, el símbolo (→ # 53) significa: consulte la página 53.

4.1.3 Símbolos usados

Símbolo	Indicación
 PELIGRO	Indica una situación peligrosa que, si no se evita, provocará la muerte o lesiones graves.
 ADVERTENCIA	Indica una situación peligrosa que, si no se evita, puede provocar la muerte o lesiones graves.
 ATENCIÓN	Indica una situación peligrosa que, si no se evita, puede provocar lesiones moderadas o leves.
NOTICE	Indica situaciones que, si no se evitan, pueden provocar daños materiales.
NOTE	Este símbolo indica notas importantes.
	Advertencia de peligro (general). En el texto que aparece junto al símbolo se especifica el tipo de peligro.
	Advertencia de peligro por electricidad y sus efectos.
	Advertencia de peligro por superficie caliente.
	Advertencia de cargas suspendidas.

4.2 de Seguridad

Esta sección le ayuda a reconocer y evitar peligros para las personas y los objetos.

4.2.1 Debería prestar atención a las siguientes indicaciones

¡Se necesita personal especializado!

Las tareas de transporte, montaje, puesta en funcionamiento y mantenimiento solo las deben realizar trabajadores debidamente cualificados. Los trabajadores cualificados y especializados son personas que están familiarizadas con el transporte, la instalación, el montaje, la puesta en marcha y el funcionamiento de motores, y que disponen de las correspondientes calificaciones profesionales.

- Transporte: solo personal con conocimientos en el manejo de componentes con sensibilidad electrostática.
- Instalación mecánica: solo personal con formación en mecánica.
- Instalación eléctrica: solo personal con formación en electrotecnia.
- Puesta en funcionamiento: solo personal cualificado con amplios conocimientos de ingeniería eléctrica y tecnología de accionamientos

El personal cualificado debe conocer y cumplir con las normas IEC 60364/IEC 60664 y las normas nacionales de prevención de accidentes.

¡Lea la documentación!

Lea la documentación disponible antes de realizar la instalación y la puesta en marcha. El manejo inadecuado del motor puede causar daños personales o materiales. Por lo tanto, el operario debe asegurarse de que todas las personas que deban trabajar con el motor hayan leído y entendido el manual y que cumplan con las advertencias de seguridad que se incluyen ahí.

¡Preste atención a los datos técnicos!

Respete los datos técnicos y las especificaciones sobre las condiciones de conexión (placa de características y documentación). Si se superan los valores de tensión permitidos, los motores podrían resultar dañados, por ejemplo, por sobrecalentamiento.

¡Realice una evaluación de riesgos!

El fabricante de la máquina debe generar una evaluación de riesgos para la máquina y tomar las medidas apropiadas para asegurar que ningún movimiento imprevisto pueda provocar lesiones a alguien o daños materiales. De la evaluación de riesgos pueden surgir requisitos adicionales para el personal especializado.

¡Transporte la máquina de forma segura!

Los motores que pesen más de 20 kg (AKM2G7) solo deben levantarse y moverse con herramientas de elevación; de lo contrario, podrían producirse lesiones de espalda. Tenga siempre en cuenta las sugerencias sobre [Transporte](#)

¡Cuidado con la llave!

Retire todas las llaves instaladas (si las hay) del eje antes de poner en marcha el motor sin carga de par para evitar el peligro de que la llave salda despedida a causa de la fuerza centrífuga. Cuando se entrega, la llave está protegida con una tapa de plástico.

¡Superficie caliente!



Las superficies de los motores pueden estar muy calientes durante el funcionamiento, según su categoría de protección. ¡Riesgo de quemaduras leves! La temperatura de la superficie puede superar los 100° C. Mida la temperatura y espere a que el motor se haya enfriado por debajo de los 40 °C antes de tocarlo.

¡Conexión a tierra! ¡Altas tensiones!



Es fundamental garantizar que el alojamiento del motor esté conectado de forma segura a la barra colectora de la puesta a tierra de protección (PE) en el armario de distribución. Riesgo de descarga eléctrica. Sin una puesta a tierra de baja resistencia, no es posible garantizar la protección personal y existe riesgo de muerte por descarga eléctrica.

No tener monitores ópticos no garantiza la ausencia de tensión. Las conexiones eléctricas pueden tener tensión aunque el eje del motor no esté girando.

No desenchufe ninguna conexión durante el funcionamiento. Si se tocan los contactos expuestos al exterior, existe riesgo de muerte o de lesión grave. Las conexiones eléctricas pueden tener corriente cuando el eje del motor no está girando. Esto puede provocar descargas disruptivas y resultar en lesiones a las personas y daño a los contactos.

Tras desconectar el servoamplificador de la tensión de entrada, espere varios minutos antes de tocar los componentes que normalmente tienen corriente (p. ej., contactos, conexiones con tornillos) o de abrir las conexiones.

Los condensadores del servoamplificador aún pueden tener una tensión peligrosa varios minutos después de desconectar las tensiones de entrada. Para estar seguro, mida la tensión de la conexión de CC y espere hasta que la tensión haya caído por debajo de los 60 V.

¡Amarre las cargas suspendidas!



¡Los frenos de retención integrados no garantizan un funcionamiento seguro! El usuario deberá tener en cuenta los estándares de seguridad locales si hay cargas suspendidas (ejes verticales) y la necesidad de garantizar la seguridad personal mediante el uso de medidas adicionales para evitar riesgos.

4.2.2 Uso correcto

- La serie AKM2G de servomotores síncronos está diseñada especialmente para accionamientos de robots industriales, máquinas-herramienta, maquinaria textil y de envasado y máquinas similares con elevados requerimientos dinámicos.
- Solo se permite usar los motores con las condiciones ambientales que se describen en este documento.
- La serie AKM2G de motores está pensada **exclusivamente** para usarse con servoamplificadores con control de velocidad o par motor.
- Los motores se instalan como componentes en máquinas o aparatos eléctricos y solo se pueden poner en marcha como componentes integrales de dichas máquinas o aparatos.
- El sensor térmico que está integrado en las bobinas del motor debe supervisarse y evaluarse.
- Los frenos de retención están diseñados como frenos de parada y no son adecuados para operaciones de frenado repetidas durante el funcionamiento.
- Solamente se garantiza la conformidad del servosistema con los estándares mencionados en la Declaración de conformidad CE [Approvals](#) si los componentes (servoamplificador, motor, cables, etc.) usados han sido suministrados por Kollmorgen permitidas.

4.2.3 Uso prohibido

- El uso de motores **estándar** no está permitido
 - directamente en la red,
 - en áreas con peligro de explosión,
 - en contacto con alimentos y bebidas,
 - en entornos con polvos, aceites, vapores, lejías y ácidos cáusticos o conductores de la electricidad.
- No se permite poner en marcha el motor si la máquina en la que está instalado
 - no cumple los requisitos de la Directiva sobre maquinaria de la CE,
 - no cumple con la Directiva sobre compatibilidad electromagnética,
 - no cumple con la Directiva sobre equipos de baja tensión,
- Con el fin de garantizar la seguridad funcional, no se deben utilizar los frenos de retención integrados sin un equipo adicional.

4.2.4 Manipulación

4.2.4.1 Transporte

- Clase de clima 2K3 según EN61800-2, IEC 60721-3-2
- Temperatura: de -25 a +70 °C, oscilación máx. 20K/hora
- Humedad : relativa del 5 % al 95 %, sin condensación
- Solo a cargo de personal cualificado en el embalaje reciclable original del fabricante
- Evite los golpes, especialmente en el extremo del eje
- En caso de que el embalaje esté dañado, compruebe que el motor no tenga daños visibles. Informe de ello al transportista y, en caso necesario, al fabricante.

Transporte de motores de más de 20 kg de peso

Deben usarse argollas de elevación para el transporte seguro de los motores AKM2G7 (> 20 kg). Respete todas las instrucciones relativas al transporte incluidas en el embalaje del motor.

Recomendamos la herramienta de transporte ZPZM 120/292 para transportar los motores.

La unidad de suspensión ZPMZ 120/292 consiste en una viga, suspendida del gancho de una grúa, y dos cadenas de recorrido doble.



PELIGRO

Carga suspendida. Peligro de muerte si se cae la carga. La zona bajo la carga debe estar siempre despejada cuando el motor esté elevado.

- Los tornillos de fijación de las argollas de elevación deben estar completamente enroscados.
- Las argollas de elevación deben asentarse totalmente planas en la superficie de apoyo.
- Antes de utilizarlas, compruebe si las argollas de elevación están firmemente asentadas y si presentan daños visibles (corrosión, deformación).
- Las argollas de elevación deformadas no deben utilizarse.

B1/ 4 x Lifting Bolt Plus Lifting Beam

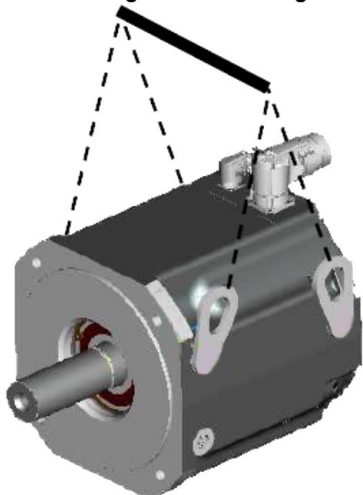

B2/ 2 x Lifting Bolt Plus Lifting Beam

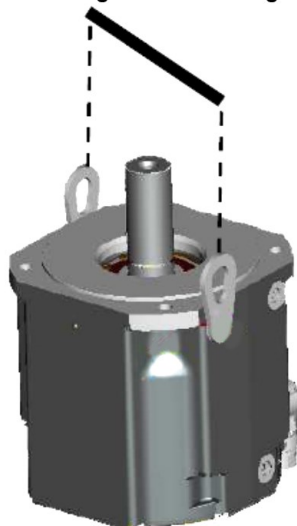

B3/ 2 x Lifting Bolt Plus Lifting Beam

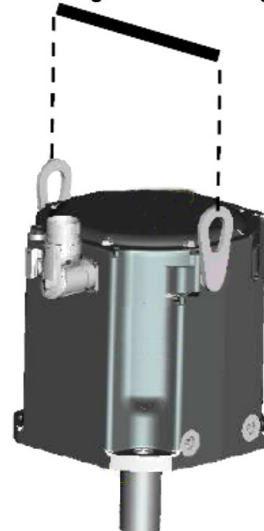

4.2.4.2 Embalaje

- Caja de cartón con amortiguador de espuma Instapak®.
- Puede devolver la partes de plástico al proveedor (consulte "Eliminación").

Tipo de motor	Embalaje	Altura máx. de apilamiento
AKM2G2	Cartón	10
AKM2G3	Cartón	6
AKM2G4	Cartón	6
AKM2G5	Cartón	5
AKM2G6	Cartón	1
AKM2G7	Cartón	1

4.2.4.3 Almacenamiento

- Clase de clima 1K4 según EN61800-2, IEC 60721-3-1
- Temperatura de almacenamiento: de -25 a +55 °C, oscilación máx. 20K/hora.
- Humedad : relativa del 5 % al 95 %, sin condensación
- Almacenar solo en el embalaje reciclable original del fabricante
- Altura máx. de apilamiento: consulte la tabla de la sección "Embalaje"
- Tiempo de almacenamiento: ilimitado

4.2.4.4 Mantenimiento/limpieza

- Mantenimiento y limpieza solo a cargo de personal cualificado
- Después de 20.000 horas de servicio en condiciones nominales, el fabricante debe cambiar los cojinetes.
- Compruebe el motor cada 2.500 horas de servicio, o una vez al año, para asegurarse de que los cojinetes no hagan ruido. Si escucha ruidos, detenga el motor inmediatamente y contacte con el fabricante para sustituir los cojinetes.
- Si abre el motor, la garantía quedará invalidada.
- Si el alojamiento está sucio, límpielo con isopropanol o algún producto similar; no sumergir ni pulverizar

4.2.4.5 Reparación/eliminación

Solo el fabricante debe realizar reparaciones en el motor. Si abre el motor, la garantía quedará invalidada. De conformidad con la directiva WEEE-2012/19/EG, nos encargamos de eliminar de manera profesional los aparatos y accesorios viejos si el remitente se hace cargo de los gastos de transporte. Envíe el motor a:

Kollmorgen s.r.o.

A la atención de: Departamento de reparaciones
 Evropska 864
 664 42 Modrice / República Checa
 Correo electrónico: brno_customer_repairs@kollmorgen.com
 Teléfono: +420 533 314 455

4.3 Paquete

4.3.1 Paquete de entrega

- Motor de la serie AKM2G .
- Manual del producto (multilingüe) impreso, uno por entrega.

4.3.2 Placa de identificación

En los motores estándar, la placa de identificación es un adhesivo en el lateral del alojamiento.

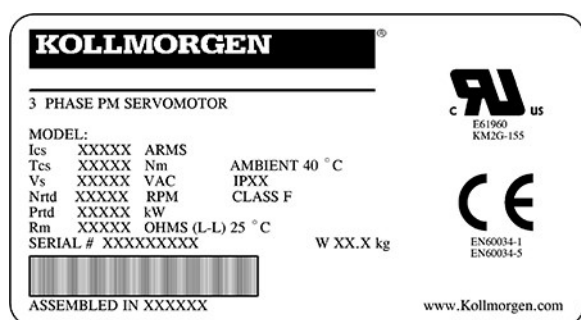
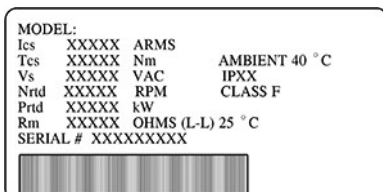

Leyenda	Descripción
MODEL	tipo de motor
Ics	corriente de parada
Tcs	par de parada
Vs	U_N (tensión de suministro)
Nrtd	nn (velocidad nominal a U_N)
Prtd	Pn (potencia nominal)
Rm	R25 (resistencia de devanado a 25°)
SERIAL	n.º de serie
AMBIENT	temp. ambiente máxima
W	Peso del motor en kg
IPXX	Grado de protección de ingreso
CLASS F	Grado de aislamiento

El año de fabricación aparece en el número de serie: los dos primeros dígitos del número de serie son el año de fabricación; p. ej., "17" significa 2017.

4.3.3 Descripción de los números de modelo AKM2G

4.3.3.1 Esquema de los números de referencia

El esquema de los números de referencia debe usarse únicamente para la identificación de los productos, no para realizar pedidos, ya que no están disponibles todas las combinaciones teóricas de características.

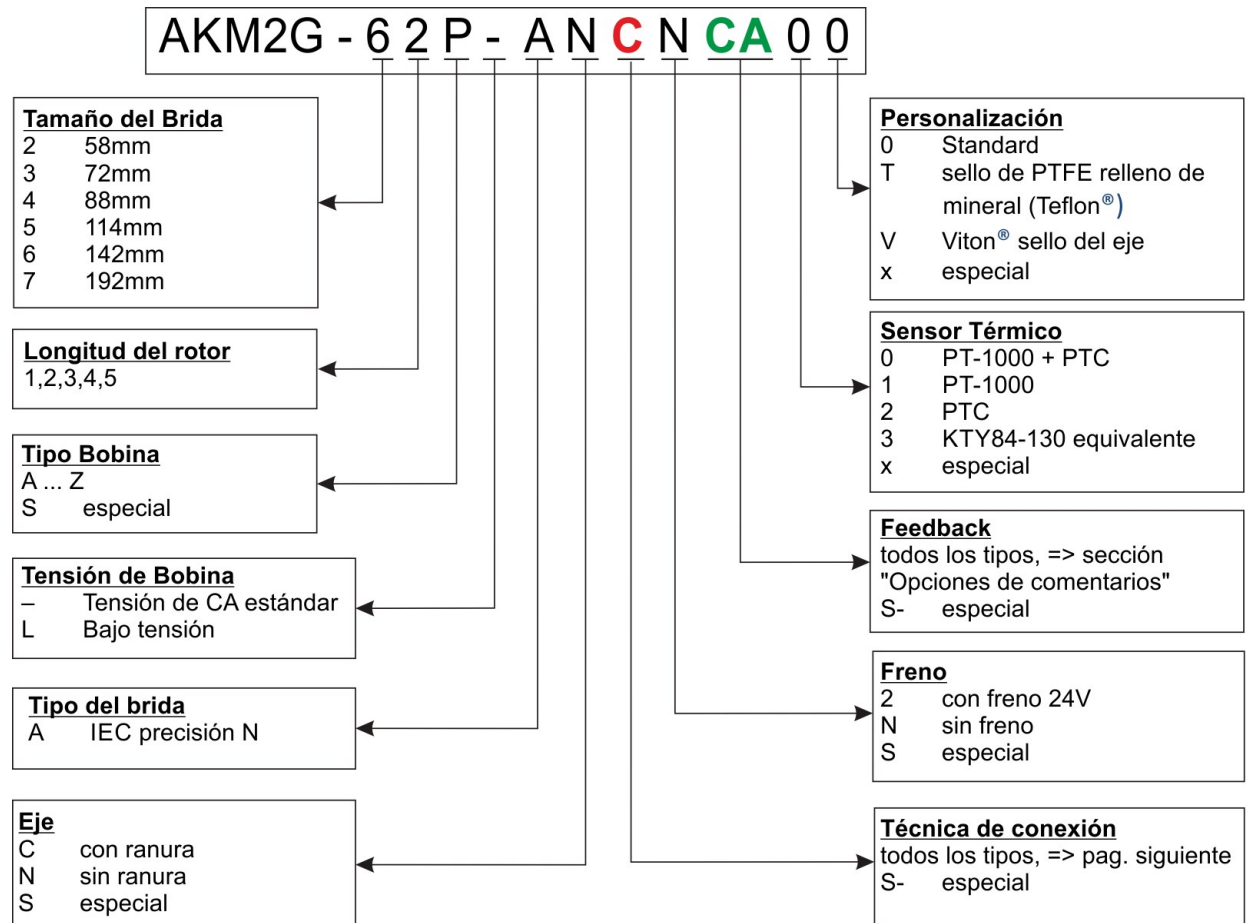

4.3.3.2 Opciones de conexión (C)

La asignación de las opciones de conexión figuran en el capítulo "Asignación de conexiones" a partir de [Conector Pinout](#) permitidas.

4.3.3.3.1 Descripción de conexiones

Conexión	Uso*	Contactos - Pines	Dislocación vibratoria máx. [A]	Dislocación vibratoria transversal máx. [mm ²]	Clase de protección	Tamaño del cable conductor de alimentación (mm ²)	Conector correspondiente sugerido
		Potencia/ Señal	Potencia/ Señal	Potencia/ Señal			
Conexiones M23 en ángulo recto SpeedTec (Tamaño 1)	Potencia y freno	4 / 5	20 / 10	4 / 1,5	IP65	1,5	BSTA-082-FR-46-58-0100-000
						2,5	BSTA-082-FR-46-58-0100-000
						4,0	BSTA-082-FR-32-59-0100-000
	Transductor	- / 12	- / 10	- / 0,5	IP65	-	ASTA-013-FR-01-62-0100-000
	Codificador	- / 17	- / 10	- / 0,5	IP65	-	ASTA-014-FR-01-61-0100-000
	Híbrido (SFD3)	4 / 5	20 / 10	4 / 1,5	IP65	1,5	BSTA-082-FR-46-58-0100-000
						2,5	BSTA-082-FR-46-58-0100-000
						4,0	BSTA-082-FR-32-58-0100-000
	Híbrido (DSL)	4 / 5	20 / 10	4 / 1,5	IP65	1,5	H51A-425-FR-14-58-0100-000 + 40.A711.00
						2,5	H51A-425-FR-14-58-0100-000 + 40.A711.00
						4,0	H51A-425-FR-15-59-0100-000 + 40.A711.00
	Híbrido (EnDat)	4 / 5	20 / 10	4 / 1,5	IP65	1,5	H51A-405-FR-14-59-0100-000 + 40.A702.00
						4,0	H51A-405-FR-15-59-0100-000 + 40.A702.00

Conexión	Uso*	Contactos - Pines	Dislocación vibratoria máx. [A]	Dislocación vibratoria transversal máx. [mm ²]	Clase de protección	Tamaño del cable conductor de alimentación (mm ²)	Conector correspondiente sugerido
		Potencia/ Señal	Potencia/ Señal	Potencia/ Señal			
M40 (tamaño 1,5)	Potencia y freno	4 / 5	75 / 30	16 / 4	IP65	4,0	CSTA-265-FR-06-26-0020-000
						6,0	CSTA-265-FR-06-25-0020-000
						10,0	CSTA-265-FR-06-25-0020-000
	Híbrido (SFD3)	4 / 5	75 / 30	16 / 4	IP65	4,0	CSTA-265-FR-06-26-0020-000
						6,0	CSTA-265-FR-06-25-0020-000
						10,0	CSTA-265-FR-06-25-0020-000
	Híbrido (DSL)	4 / 5	75 / 30	16 / 4	IP65	4,0	H81A-501-FR-03-44-0100-000 + 40.A711.00
						6,0	H81A-501-FR-03-45-0100-000 + 40.A711.00
	y-tec	Potencia y freno	4 / 5	14 / 3,6	1,5 / 0,75	IP65	1,5
Retroalimentación		- / 12	- / 5	- / 0,75	IP65		ESTB-002-FR-02-32-0001-000

Híbrido (SFD3) significa Potencia y retroalimentación SFD3 (más freno) en la misma conexión y en un cable.

Híbrido (DSL) significa Potencia y retroalimentación DSL (más freno) en la misma conexión y en un cable.

Híbrido (EnDat) significa Potencia y retroalimentación EnDat (más freno) en la misma conexión y en un cable.

4.3.3.4.2 Designación de conexiones - Motor

Designación del modelo	Conexión	Se puede usar con	Posición de la conexión
C	2 SpeedTec M23	AKM2G3 - AKM2G7 ≤ 20 A	Angular, giratoria, montada en motor
D*	1 híbrida M23	AKM2G2 - AKM2G7 ≤ 20 A	Angular, giratoria, montada en motor
G	2 SpeedTec M23	AKM2G3 - AKM2G7 ≤ 20 A	Recta, montada en motor
H	1 M40 de potencia, 1 M23 de retroalimentación	AKM2G7 > 20 A	Angular, giratoria, montada en motor
J*	1 conexión híbrida M40	AKM2G7 > 20 A	Angular, giratoria, montada en motor
Y	1 conexión Y-Tec	AKM2G2	Giratoria, montada en motor

* Conexiones híbridas válidas solo para SFD3, DSL y EnDat.

4.3.3.5 Opciones de retroalimentación (CA)

La longitud del motor depende del dispositivo de retroalimentación integrado, consulte los diagramas de dimensiones a partir de [Dimension drawings](#) permitidas.

No es posible la retroalimentación. La asignación de las opciones de conexión figuran en [Connector Pinout](#) permitidas.

4.3.3.6.1 Descripción de la retroalimentación

Código	Descripción	Compatibilidad del ID del motor 3	Precisión 1,2 (segundo de arco)	Ruido RMS 1 (segundo de arco)	Comentarios	Resolución	Una fiabilidad absolutas	Unidades compatibles	Asistencia de seguridad operativa 4
CA	SFD3	Sí	±585"	±9,9"	Inductiva	24 bits	1	Gama AKD	No
GU	Hiperface DSL	Sí	±240"	±20"	Capacitiva	17 bits	4096	Gama AKD	hasta SIL2 7,9
LD 5	EnDat 2.2	Sí	±120" ±65"	Consulte la nota 6 abajo	Inductiva	19 bits	4096	Gama AKD	hasta SIL310
R-	Transductor	No	±540"	N/D	Inductiva	24 bits para AKD	1	Todas	No
2- 8	Codificador de conmutación	No	+/- 218,2"	N/D	Óptica	12 bits	ninguna	Gama AKD	

- Las unidades AKD disponen de una precisión en la medición del transductor de ±45" para una unidad con una precisión del motor de ±585" y un ruido RMS de ±9,9".
- Precisión hace referencia a la precisión general del sistema una vez instalado en el motor. Ruido hace referencia al ruido de la posición RMS en parado.
- Compatibilidad del ID del motor significa que se incluyen los datos de la placa de identificación del motor electrónico para facilitar la puesta en marcha mediante plug-and-play.
- El Nivel de Integridad de Seguridad (SIL, por sus siglas en inglés) del dispositivo indicado por el fabricante del sistema de retroalimentación. El cliente es responsable del grado de seguridad operativa.
- Para los motores de retroalimentación EnDat, la aceleración está limitada a $\leq 1 \cdot 10^5$ rad/s² permitidas. Es posible que el servoaccionamiento conectado limite de manera adicional este valor.
- Esta información no estaba disponible en el momento de la impresión. Póngase en contacto con el servicio de atención al cliente de Kollmorgen para obtener la actualización más reciente.
- Para motores con el número de serie 1935100001 o posterior.
- Disponible solo en motores de baja tensión AKM2G3 y superiores.
- Consulte el sitio web del fabricante (enlace abajo) para obtener información precisa acerca de las especificaciones de seguridad operativa de este sistema de retroalimentación. La sección "Parámetros relacionados con la seguridad" contiene información específica sobre los parámetros de seguridad del producto. Las demás secciones aportan detalles adicionales.
www.sick.com/us/en/motor-feedback-systems/motor-feedback-systems-rotary-hiperface-dsl/eeseem37/eem37-2kf0a017a/p/p486170
- La información del sitio web y los enlaces están actualizados desde la fecha de publicación de este manual. Como alternativa, puede buscar el número de producto 1067125 en el sitio web.
- Para obtener información precisa acerca de las especificaciones de seguridad operativa de este sistema de retroalimentación, consulte el sitio web del fabricante que se incluye abajo.
www.heidenhain.com/en_US/products/rotary-encoders/without-integral-bearing/
En esta página, seleccione el enlace del documento adecuado para la retroalimentación utilizada en el motor AKM2G permitidas.

AKM2G , tamaño	Núm. de modelo del fabricante	Información general de seguridad	Información específica del modelo
tamaño de bastidor 2-4	EQI 1131	páginas 28-29	páginas 72-75
tamaño de bastidor 5-7	EQI 1331	páginas 28-29	páginas 78-79

La información del sitio web y los enlaces están actualizados desde la fecha de publicación de este manual. Como alternativa, puede buscar el número de modelo anterior en el sitio web.

4.3.3.7.2 Opciones de conexión disponibles mediante elección de retroalimentación

SFD3

Tipo de conexión	Unidades AKM2Gx compatibles	Tipo
D	AKM2G2-4	Tamaño 15
D	AKM2G5-7 ≤ 20 A	Tamaño 21
J	AKM2G7 > 20 A	Tamaño 21

Hiperface DSL

Tipo de conexión	Unidades AKM2Gx compatibles	Tipo
D	AKM2G2-7 ≤ 20 A	EEM37
J	AKM2G7 > 20 A	EEM37

EnDat 2.2

Tipo de conexión	Unidades AKM2Gx compatibles	Tipo
D	AKM2G2-4	EQI 1131
D	AKM2G5-7 ≤ 20 A	EQI 1331

Transductor

Tipo de conexión	Unidades AKM2Gx compatibles	Tipo
Y	AKM2G2	Tamaño 15
C / G	AKM2G3-4	Tamaño 15
C / G	AKM2G5-7 ≤ 20 A	Tamaño 21
H	AKM2G7 > 20 A	Tamaño 21

Codificador de conmutación

Tipo de conexión	Unidades AKM2Gx compatibles	Tipo
C / G	AKM2G3-4	Tamaño 15

4.4 Descripción técnica

4.4.1 Datos técnicos generales

Temperatura ambiente (con valores nominales)	De 5 a +40 °C con altitudes de hasta 1000 m sobre el nivel del mar Es fundamental consultar a nuestro departamento de aplicaciones en caso de temperaturas ambiente por encima de los 40 °C y con montaje encapsulado de los motores.
Humedad permitida (con valores nominales)	95 % de humedad relativa, sin condensación
Reducción de potencia (corrientes y pares)	1 %/K en el rango de 40 a +50 °C con altitudes de hasta 1000 m sobre el nivel del mar con altitudes superiores a los 1000 m sobre el nivel del mar y 40 °C 6 % hasta 2000 m sobre el nivel del mar 17 % hasta 3000 m sobre el nivel del mar 30 % hasta 4000 m sobre el nivel del mar 55 % hasta 5000 m sobre el nivel del mar Sin reducción de potencia con altitudes superiores a los 1000 m sobre el nivel del mar con reducción de la temperatura de 10K/1000 m
Vida útil de los cojinetes	≥ 20.000 horas de servicio

NOTE

Puede encontrar los datos técnicos de cada tipo de motor en el capítulo "Datos Técnicos" a partir de [Technical Data](#) permitidas.

4.4.2 Características estándares

4.4.2.1 Estilo

El estilo básico de los motores AKM2G es IM B5 conforme a la norma EN 60034-7.

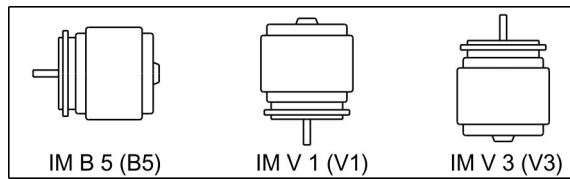

4.4.2.2 Brida

Precisión de la brida IEC conforme a la norma DIN 42955. Tolerancias de la prolongación de la extensión del eje y de las bridas de montaje para las máquinas eléctricas giratorias.

Código	Brida
Un	IEC con precisión N, ajuste AKM2G2-7: j6

4.4.2.3 Clase de protección

Según EN 60529.

Motor estándar	Opción de conexión	Sello del eje	Clase de protección
AKM2G2-AKM2G7	C, D, G, H, J, Y	sin	IP54
AKM2G2-AKM2G7	C, D, G, H, J, Y	con	IP65

4.4.2.4 Clase de material aislante

Los motores se suministran con la clase F de materiales aislantes según la norma IEC 60085 (UL1446 clase F).

4.4.2.5 Superficie

Los motores están cubiertos con polvo de poliéster epoxi en negro mate. Este acabado no es resistente a los disolventes (p. ej., tricloroetileno, diluyentes o similar).

4.4.2.6 Extremo del eje, lado A

La fuerza se transmite a través del extremo del eje cilíndrico A, ajuste k6 según la norma EN 50347, con rosca de bloqueo pero **sin un chavetero instalado** permitidas.

Los motores también están disponibles con chavetero y llave insertada según la norma DIN 6885. El eje con chavetero se equilibra con una llave corta (mitad).

La vida útil de los cojinetes se calcula en 20.000 horas de servicio.

Código de pedido	Extremo del eje	Disponible para
N	Eje liso	AKM2G 2-7
C	Chavetero, cerrado	AKM2G 2-7

Fuerza radial

Si los motores funcionan con piñones o correas dentadas, se generarán grandes fuerzas radiales. Los valores permitidos en el extremo del eje se pueden leer en los diagramas del capítulo "Diagramas" a partir de [Dimension drawings](#) permitidas. Los valores máximos a la velocidad nominal figuran en los datos técnicos a partir de [Technical Data](#) permitidas. La toma de fuerza desde el centro del extremo libre del eje permite un aumento del 10 % en F_R permitidas.

Fuerza axial

Cuando se montan piñones o ruedas en el eje y se usan, por ejemplo, engranajes angulares, se generan fuerzas axiales. Los valores máximos a la velocidad nominal figuran en los datos técnicos.

Acoplamiento

Las tenazas tensoras han dado muy buen resultado como elementos ideales de acoplamiento sin juego combinadas, si es necesario, con acoplamientos de fuelle metálico. Orificio central del eje conforme a DIN 332, Tipo D.

4.4.2.7 Sello del eje

Si AKM2G se conecta a la brida de una máquina con una zona del eje sin sellado, el sello del eje (opción "T" o "V") garantiza el sellado del eje.

- La opción de sellado "T" está compuesta por un sello PTFE relleno de mineral (teflón) autolubrificante y que se recomienda para aplicaciones en las que no es posible efectuar una lubricación regular del sello del eje.
- La opción de sellado "V" está compuesta por Viton® y se recomienda para aplicaciones en las que se efectúa una lubricación regular del sello del eje, como en las cajas de cambio lubricadas.
- El sello del eje garantiza la protección IP65 en la zona del eje.
- El rendimiento nominal se logra tras varias horas de rodaje del sello del eje. No se necesita ningún procedimiento especial para el rodaje.
- Si se desprende un poco de material del sello del eje, en particular teflón, es normal; esto no afecta a la función.
- El sello del eje está prelubricado con grasa.

4.4.2.8 Dispositivo de protección

La versión estándar de corriente alterna de cada motor viene equipada con un PT-1000+ PTC aislado eléctricamente. La versión de baja tensión de cada motor viene equipada con un PT-1000 aislado eléctricamente. Los sensores térmicos no protegen contra sobrecargas instantáneas muy altas.

También existe la opción de equipar el motor con sensores equivalentes PT-1000 +PTC, PT-1000, PTC o KTY 84-130 (consulte [Opciones del dispositivo térmico: gráficos de resistencia y temperatura](#) las opciones 0, 1, 2 y 3).

Con sistemas de retroalimentación digitales SFD3 (CA), Hiperface DSL (GU) y EnDat 2.2 (LD), el estado del sensor de temperatura se transmite digitalmente y se evalúa en el funcionamiento.

Cuando se usan nuestros cables de retroalimentación configurados, el sensor está integrado en el sistema de supervisión de los servoamplificadores digitales.

4.4.2.9.1 Opciones del dispositivo térmico: gráficos de resistencia y temperatura

Las curvas de la opción del dispositivo térmico muestran la resistencia equivalente en ohmios que se corresponde con una determinada temperatura de las bobinas del motor. El sistema utilizado con el motor debe ser compatible con el dispositivo térmico seleccionado para funcionar adecuadamente.

Opción del dispositivo térmico 0

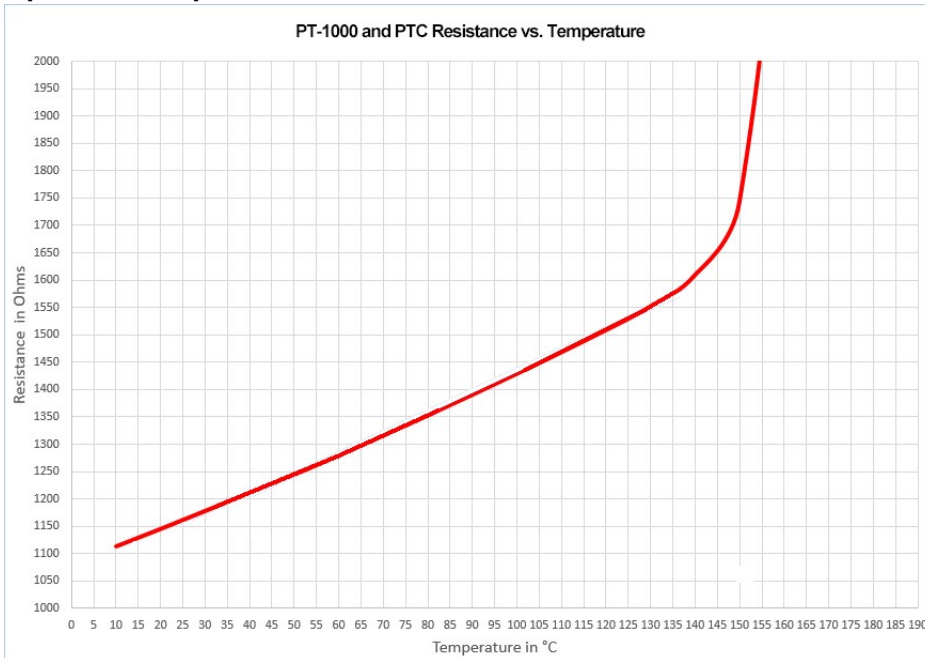

Opción del dispositivo térmico 1

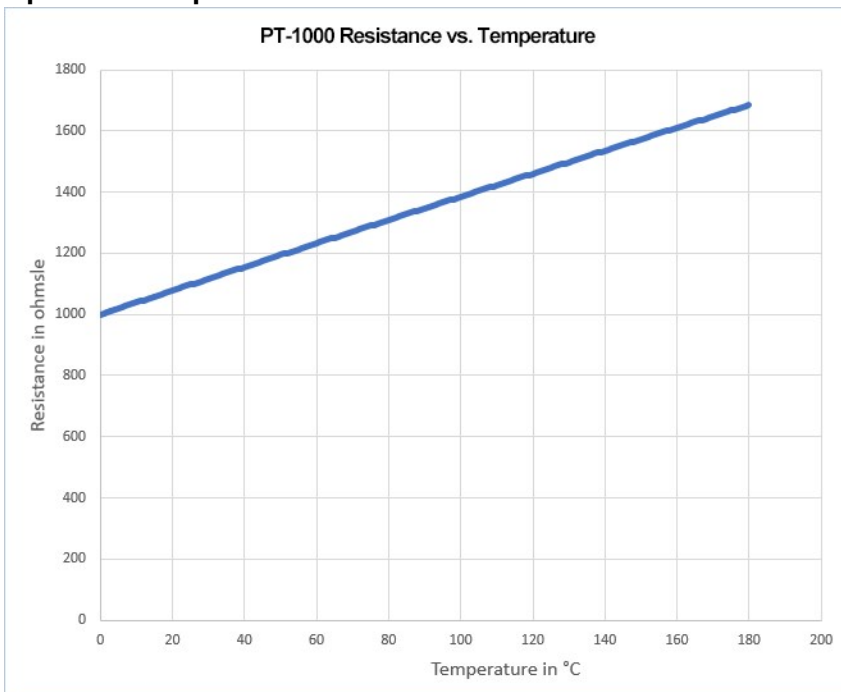

Opción del dispositivo térmico 2

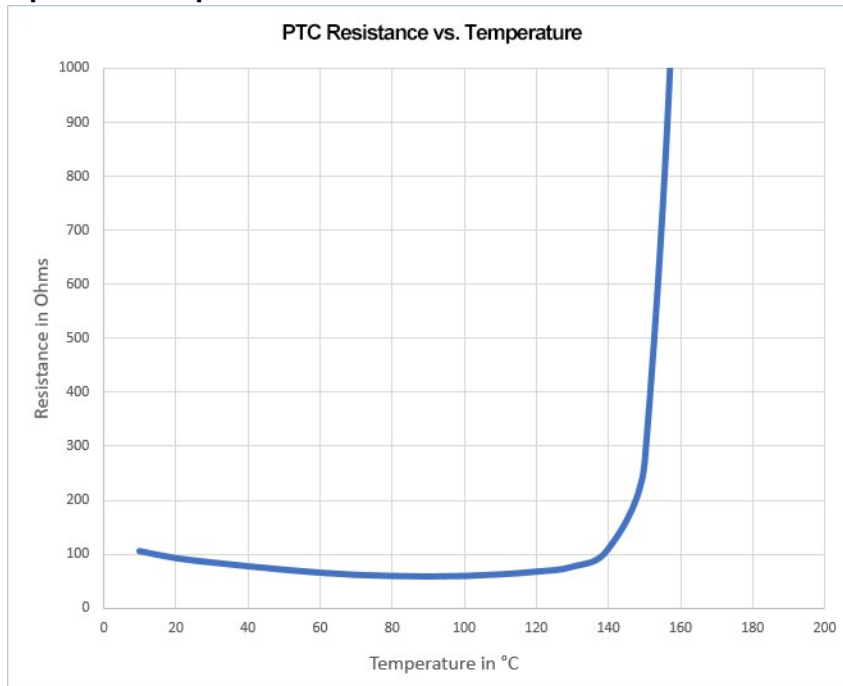

Opción del dispositivo térmico 3

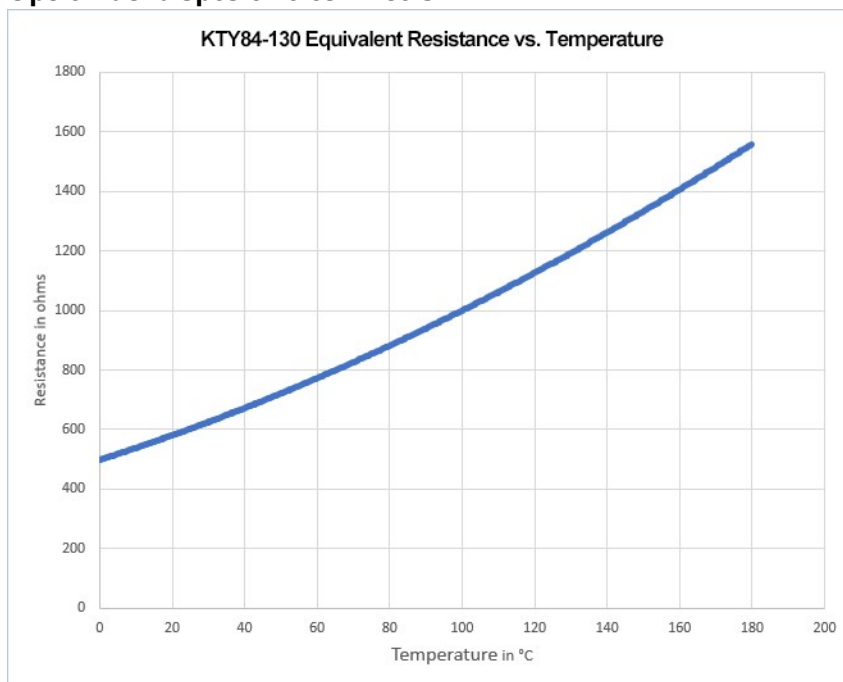

4.4.2.10 Clase de calidad vibracional

Los motores se fabrican con la clase A de calidad vibracional conforme a la norma EN 60034-14. Esto implica que el valor real de vibraciones permitido para un rango de velocidades de 600-3600 rpm y una altura del eje de entre 56-132 mm es de 1,6 mm/s.

Velocidad [rpm]	Dislocación vibratoria máx. rel. [μm]	Holgura. máx. [μm]
≤ 1800	90	23
> 1800	65	16

4.4.3 Tecnología de cableado

4.4.3.1 Conexiones

Descripción de las conexiones disponibles: [Opciones de conexión \(C\)](#) permitidas. Asignación de conexiones: a partir de [Connector Pinout](#) permitidas.

4.4.3.2 Secciones transversales de los cables

(Secciones transversales del cable para temperaturas ambientales de 40 °C.)

Cable de alimentación, cable combinado

Los cables combinados incluyen 4 líneas de alimentación, además de 2 líneas adicionales, para el control del freno de retención del motor.

Sección transversal		Capacidad de conducción de corriente	Comentarios
Tamaño	Cable combinado		
(4x1)	(4x1+(2x0,75))	0 A < I _{0rms} ≤ 10,1 A	Los paréntesis (...) indican el apantallamiento. Capacidad de conducción de corriente según la norma EN60204-1:2006 Tabla 6, Columna B2
(4x1,5)	(4x1,5+(2x0,75))	10,1 A < I _{0rms} ≤ 13,1 A	
(4x2,5)	(4x2,5+(2x1))	13,1 A < I _{0rms} ≤ 17,4 A	
(4x4)	(4x4+(2x1))	17,4 A < I _{0rms} ≤ 23 A	
(4x6)	(4x6+(2x1))	23 A < I _{0rms} ≤ 30 A	
(4x10)	(4x10+(2x1,5))	30 A < I _{0rms} ≤ 40 A	
(4x16)	(4x16+(2x1,5))	40 A < I _{0rms} ≤ 54 A	
(4x25)	(4x25+(2x1,5))	54 A < I _{0rms} ≤ 70 A	

Cable de retroalimentación

Tipo	Sección transversal	Comentarios
Transductor	(4x2x0,25)	
Codificador	(4x2x0,25)	

Cable híbrido

Tipo	Sección transversal	Comentarios
SFD3/DSL	(4x1,0+(2x0,34)+(2x0,75))	4 líneas de alimentación, 2 líneas de freno y 2 líneas de señal para SFD3/DSL 6 líneas de señal para EnDat 2.2
SFD3/DSL	(4x1,5+(2x0,34)+(2x0,75))	
SFD3/DSL	(4x2,5+(2x0,34)+(2x1,0))	
SFD3/DSL	(4x4,0+(2x0,34)+(2x1,0))	
SFD3/DSL	(4x6,0+(2x0,34)+(2x1,0))	
EnDat 2.2	(4x1,5 + (2x0,75) + (2x (2x0,14) + (2x0,25)))	
EnDat 2.2	(4x4,0 + (2x1,0) + (2x (2x0,14) + (2x0,25)))	

4.4.4 Freno de retención

Todos los motores se pueden suministrar opcionalmente con freno de retención. Los motores incorporan un freno de resorte (24 V CC). Este freno bloquea el rotor cuando está sin tensión.



ADVERTENCIA

¡Si hay una carga suspendida (ejes verticales), el freno de retención del motor se acciona y, al mismo tiempo, el servoaccionamiento no genera potencia, lo que puede provocar la caída de la carga! Riesgo de lesión para el personal que usa la máquina. El usuario deberá tener en cuenta los estándares de seguridad locales si hay cargas suspendidas (ejes verticales) y la necesidad de garantizar la seguridad personal mediante el uso de medidas adicionales para evitar riesgos.

NOTICE

Los frenos de retención están diseñados como frenos de parada y no son adecuados para operaciones de frenado repetidas durante el funcionamiento. Si el freno se acciona con frecuencia durante el funcionamiento, es posible que se desgaste prematuramente y falle.

La longitud del motor aumenta cuando se monta un freno de retención.

El freno de retención se puede controlar directamente con el servoamplificador (con riesgo para las personas), liberando a continuación la bobina, y no se necesitan conexiones adicionales (consulte el manual de instrucciones del servoamplificador). Cuando el freno de retención no se controla directamente con el servoaccionamiento, se deben realizar conexiones adicionales (p. ej., un varistor). Consulte a nuestro Departamento de aplicaciones.

Los datos de los frenos figuran en el capítulo "Datos técnicos de los frenos" a partir de [Technical Data Brakes](#) permitidas.

4.5 Instalación mecánica

NOTE

Puede consultar los diagramas con las dimensiones en el capítulo "[Dimension drawings](#)" permitidas.

4.5.1 Notas importantes

NOTE

El motor solo debe ser montado por personal cualificado con conocimientos de ingeniería mecánica.

- Proteja el motor contra esfuerzos excesivos. No debe dañarse ningún componente durante el transporte y la manipulación.
- El lugar de instalación se encontrará libre de materiales conductores y agresivos. Durante el montaje del V3 (extremo del eje hacia arriba), ponga atención a que no penetren líquidos en los cojinetes.
- Asegúrese de que los motores tengan una ventilación sin obstáculos, respetando la temperatura ambiente y la temperatura de la brida. Con temperaturas ambiente superiores a los 40 °C, consulte previamente con nuestro Departamento de aplicaciones. Asegúrese de que la evacuación del calor en el entorno y en la brida del motor es suficiente.
- La brida y el eje corren especial peligro durante el almacenamiento y montaje, por lo que debe evitar usar una fuerza excesiva. En la colocación de acoplamientos, engranajes o ruedas de poleas, utilice siempre la rosca de bloqueo y, siempre que sea posible, caliente los elementos de salida. Los golpes y el empleo de la fuerza producen daños en los cojinetes y en el eje.

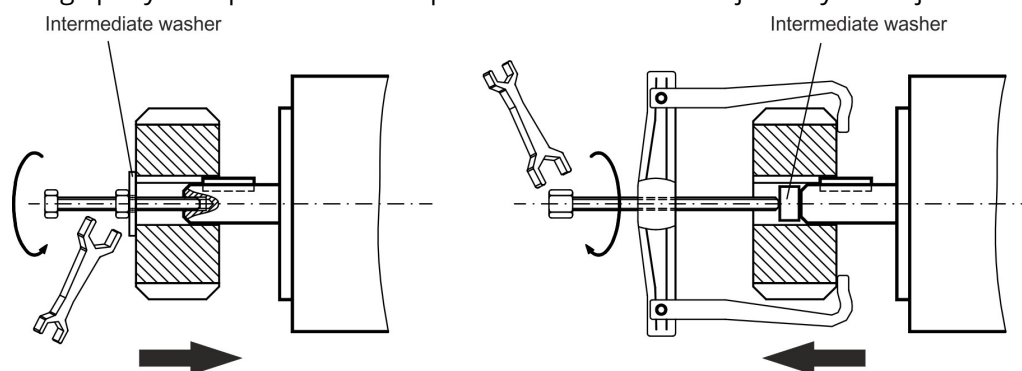

- Utilice, siempre que sea posible, tenazas de fricción sin holguras o acoplamientos. Procure siempre la correcta alineación de los acoplamientos. Las desviaciones producen vibraciones inadmisibles y destrozos en los cojinetes y el acoplamiento.
- Evite siempre la creación de una suspensión mecánica del eje del motor a través de un acoplamiento rígido y de suspensión adicional externa (p. ej., en una caja de cambios).
- Observe el número de polos del motor y del transductor (si corresponde), y ajuste correctamente el servoamplificador usado. El ajuste incorrecto puede producir la destrucción del motor, especialmente si es pequeño.
- Evite en lo posible los esfuerzos axiales del eje del motor. Los esfuerzos axiales excesivos del eje reducen mucho la vida útil del motor.
- Compruebe que se respetan las fuerzas radiales y axiales F_R y F_{U1} permitidas. Si utiliza una correa dentada, el diámetro mínimo permitido del piñón se obtiene según la ecuación: $d_{\min} \geq (M_0/F_R)^{*2}$

4.6 Instalación eléctrica

NOTE

Puede encontrar la asignación de conexiones en el capítulo "Asignación de conexiones" a partir de [Connector Pinout](#) permitidas. Puede encontrar la asignación del servoamplificador en el manual de instrucciones del servoamplificador.

4.6.1 Notas importantes

NOTE

Solamente el personal cualificado y con formación en ingeniería eléctrica está autorizado a cablear el motor.



PELIGRO

El montaje y cableado de los motores se realizará siempre sin tensión, es decir, ninguna de las tensiones de servicio del aparato a conectar deberá estar activada.



Si se tocan los contactos expuestos al exterior, existe riesgo de muerte o de lesión grave. Asegúrese de que el armario de distribución permanezca apagado (bloqueo, rótulos de advertencia, etc.). Las diferentes tensiones se conectarán en la primera puesta en funcionamiento.

No manipule nunca las conexiones eléctricas de los motores cuando se encuentren bajo tensión. ¡Riesgo de descarga eléctrica! En circunstancias desfavorables se pueden producir chispazos que dañen a las personas y los contactos.

Las cargas residuales en los condensadores del amplificador pueden generar una tensión peligrosa hasta 10 minutos después de desconectar el cable de alimentación. Las conexiones de control y de potencia pueden provocar tensión, aunque el motor no esté girando.

Mida la tensión en el circuito intermedio y espere hasta que haya descendido por debajo de 60 V.

NOTE

El símbolo de masa , que se encuentra en todos los diagramas de cableado, indica que debe realizar una conexión eléctrica en el armario de distribución con la mayor superficie posible conductora de electricidad entre el aparato que lleva la indicación y la placa de montaje. Esta conexión hará posible la derivación de interferencias de alta frecuencia y no debe confundirse con el símbolo PE (toma a tierra de protección)  (medida de protección según EN 60204).

Para cablear el motor, use los diagramas de cableado de las Instrucciones de instalación y puesta en funcionamiento del servoamplificador usado.

4.6.2 Guía de instalación eléctrica

- Compruebe la correspondencia entre el servoamplificador y el motor. Compare la tensión nominal y la corriente nominal de los aparatos. Realice el cableado conforme al diagrama de cableado del Manual de instrucciones del servoamplificador. Las conexiones del motor se encuentran en el capítulo "Asignación de conexiones" a partir de [Connector Pinout](#) permitidas.
- Realice el tendido de todos los cables de alta tensión con sección transversal suficiente según la norma EN 60204. En los Datos técnicos se incluyen las secciones recomendadas.

NOTE

En función del tipo de servoamplificador utilizado, con cables de motor largos (>25 m), debe conectarse una bobina de motor en el cable del motor (consulte el manual de instrucciones del servoamplificador y el manual de accesorios).

- Asegúrese de que la toma de tierra del servoamplificador y del motor esté perfectamente instalada. Realice la toma de tierra y el apantallamiento EMC conforme al diagrama de cableado del Manual de instrucciones del servoamplificador. Conecte a tierra la placa de montaje y el bloque del motor.
- Si utiliza un cable de alimentación del motor con conductores de mando de freno integrados, estos deberán estar apantallados. La pantalla estará dispuesta por ambos lados (consulte el Manual de instrucciones del servoamplificador).
- Cableado:
 - Tienda los cables de alimentación y de control bien separados entre sí
 - Conecte el dispositivo de retroalimentación.
 - Conecte los cables del motor; instale bobinas de motor (si corresponde) cerca del amplificador
 - Conecte apantallamientos a los terminales de blindaje o conexiones EMC en ambos extremos
 - Conecte el freno de retención, si está montado
 - Coloque el apantallamiento a ambos lados.
- Realice apantallamientos de gran superficie (baja impedancia) a través de cajas de enchufe metalizadas, o bien, de uniones de cable roscadas compatibles.
- Requisitos del material de los cables:

Capacitancia
 Cable de motor: menor que 150 pF/m
 Cable de retroalimentación: menor que 120 pF/m

4.6.3 Conexión de los motores con cables premontados

- Realice el cableado cumpliendo las normas y los reglamentos estándares vigentes.
- Utilice únicamente cables apantallados premontados de Kollmorgen para las conexiones de retroalimentación y alimentación.
- Los apantallamientos mal colocados producen interferencias electromagnéticas y degradan el rendimiento del sistema.
- La longitud máxima del cable se define en el manual de instrucciones del servoamplificador usado.

NOTE

Para obtener una descripción detallada de los cables configurados, consulte el manual de accesorios regional.

4.7 Puesta en funcionamiento

4.7.1 Notas importantes

NOTE

Solamente los profesionales con amplios conocimientos de ingeniería eléctrica y de técnicas de accionamiento están autorizados a la puesta en funcionamiento del conjunto servoamplificador-motor.



PELIGRO

Se producen tensiones peligrosas de hasta 900 V. ¡Riesgo de descarga eléctrica! Compruebe que todas las piezas de conexión que conducen tensión estén protegidas contra cualquier posible contacto.

No manipule nunca las conexiones eléctricas de los motores cuando se encuentren bajo tensión. ¡Riesgo de descarga eléctrica! Las cargas residuales en los condensadores del amplificador pueden generar tensiones peligrosas hasta 10 minutos después de desconectar el cable de alimentación.

Las conexiones de control y de potencia pueden provocar tensión, aunque el motor no esté girando. Mida la tensión en el circuito intermedio y espere hasta que haya descendido por debajo de 60 V.



ATENCIÓN

La temperatura de la superficie del motor puede superar los 100 °C durante el servicio. ¡Peligro de quemaduras leves! Compruebe (mida) la temperatura del motor. Espere a que el motor se haya enfriado por debajo de los 40 °C antes de tocarlo.



ATENCIÓN

No hay que descartar que, durante la puesta en funcionamiento, el accionamiento realice un movimiento imprevisto.

Asegúrese de que cualquier movimiento no deseado de la unidad no pueda causar peligro para personas o maquinaria.

Las medidas que habrá de observar en este aspecto en su aplicación resultarán de la valoración de riesgos de dicha aplicación.

4.7.2 Guía de puesta en funcionamiento

La forma de proceder en la puesta en funcionamiento se describe a modo de ejemplo. Dependiendo del tipo de puesta en servicio de los aparatos, puede ser adecuado o necesario un procedimiento u otro.

1. Compruebe el montaje y la orientación del motor
2. Compruebe el firme asiento de los elementos de salida de fuerza (acoplamiento, engranaje, polea de la correa), así como el ajuste correcto (respete las fuerzas radiales y axiales permitidas).
3. Compruebe el cableado y las conexiones del motor y del servoamplificador. Compruebe la correcta puesta a tierra.
4. Compruebe el funcionamiento del freno de detención, si está montado. (al aplicar 24 V, el freno se debe soltar).
5. Compruebe si el rotor del motor gira libremente (accione primero el freno, si es necesario). Compruebe si se escuchan ruidos de fricción.
6. Compruebe si se han tomado todas las medidas de protección contra contactos accidentales para las piezas móviles y las conductoras de tensión.
7. Realice todas las comprobaciones específicas y necesarias para su equipo.
8. Conforme a las instrucciones de puesta en funcionamiento del servoamplificador, ponga ahora en marcha el accionamiento.
9. En sistemas de varios ejes, ponga en marcha, una a una, cada una de las unidades de accionamiento (amplificador y motor).

4.7.3 Resolución de problemas

Considere la siguiente tabla como un botiquín de “Primeros auxilios”. Las causas de una avería pueden ser muy variadas, en función de las condiciones específicas del sistema. En primer lugar se describen las causas de fallos que pueden afectar directamente al motor. Las incidencias que se presentan en el comportamiento de regulación tienen normalmente su origen en la parametrización errónea del servoamplificador. Consulte la información al respecto en la documentación del servoamplificador y en el software de puesta en funcionamiento.

En el caso de sistemas poliaxiales, pueden existir otros defectos ocultos.

Error	Causas posibles	Medidas para la eliminación de fallos o errores
El motor no gira	<ul style="list-style-type: none"> — Servoamplificador no accionado — Conductor de valor nominal cortado — Fases del motor cambiadas — No se ha accionado el freno — El accionamiento está bloqueado mecánicamente 	<ul style="list-style-type: none"> — Conectar la señal ENABLE — Comprobar el conductor de valor nominal — Fijar correctamente las fases del motor — Comprobar el control de los frenos — Comprobar la parte mecánica
El motor gira demasiado	<ul style="list-style-type: none"> — Fases del motor cambiadas 	<ul style="list-style-type: none"> — Fijar correctamente las fases del motor
El motor vibra	<ul style="list-style-type: none"> — Se ha interrumpido el apantallamiento del cable de retroalimentación — Amplificación excesiva 	<ul style="list-style-type: none"> — Cambiar el cable de retroalimentación — Usar valores por defecto del motor
Mensaje de error: del freno	<ul style="list-style-type: none"> — Cortocircuito en el conductor de entrada de tensión del freno de retención del motor — Freno de retención del motor defectuoso 	<ul style="list-style-type: none"> — Eliminar cortocircuito — Cambiar el motor
Mensaje de error: de estadio final	<ul style="list-style-type: none"> — Cortocircuito o cortocircuito a tierra en el cable del motor — Cortocircuito o cortocircuito a tierra en el cable del motor 	<ul style="list-style-type: none"> — Cambiar el cable — Cambiar el motor
Mensaje de error: de retroalimentación	<ul style="list-style-type: none"> — La conexión de retroalimentación no está correctamente insertada — El cable de retroalimentación está interrumpido, cable aplastado o similar 	<ul style="list-style-type: none"> — Verificar la conexión — Verificar los cables
Mensaje de error: de temperatura del motor:	<ul style="list-style-type: none"> — El sensor térmico del motor se ha activado — Conexión de retroalimentación floja o cable de retroalimentación interrumpido 	<ul style="list-style-type: none"> — Esperar a que el motor se enfríe. Comprobar después por qué el motor se ha calentado. — Comprobar el conector y cambiar el cable de retroalimentación si es preciso

Error	Causas posibles	Medidas para la eliminación de fallos o errores
El freno no actúa	<ul style="list-style-type: none">— Par de detención exigido excesivamente alto— Freno defectuoso— Eje del motor con sobrecarga axial	<ul style="list-style-type: none">— Comprobar dimensionamiento— Cambiar el motor— Verificar la carga axial y reducirla. Cambiar el motor, ya que están dañados los cojinetes

4.8 Definición de los términos de Datos técnicos

NOTE

Puede encontrar los datos técnicos de cada tipo de motor en el capítulo "Datos Técnicos" [Technical Data](#) permitidas.

Todos los datos son válidos para una temperatura ambiental de 40 °C y una temperatura excesiva de la bobina de 100K. Determinación de los datos nominales con temperatura constante de la brida intermedia de 65 °C. Los datos pueden tener una tolerancia del +/- 10 %.

Par de parada M_0 [Nm]

El par de parada se puede mantener de forma indefinida a una velocidad de $0 < n < 100$ rpm y en condiciones ambientales nominales.

Par nominal M_n [Nm]

El par nominal se genera cuando el motor es alimentado con la corriente nominal a la velocidad nominal. El par nominal se puede producir de forma indefinida a la velocidad nominal en funcionamiento continuo (S1).

Corriente de parada I_{0rms} [A]

La corriente de parada es el valor efectivo de la corriente sinusoidal que consume el motor a $0 < n < 100$ rpm para generar el par de parada.

Corriente máxima (corriente pulsatoria) $I_{0máx}$ [A]

La corriente máxima (valor sinusoidal efectivo) es varias veces la corriente nominal, dependiendo de la bobina del motor. El valor real viene dado por la corriente máxima del accionamiento usado.

Constante de par K_{Trms} [Nm/A]

La constante de par indica el par en Nm que genera el motor con corriente de 1 A r.m.s. La relación es $M = I \times K_T$ permitidas.

Constante de tensión K_{Erms} [mV/min-1]

La constante de tensión indica la fuerza electromotriz inducida del motor, como valor sinusoidal efectivo entre dos terminales, por 1000 rpm. Medida a 25 °C.

Momento de inercia del rotor J [kgcm²]

La constante J es una medida de la capacidad de aceleración del motor. Por ejemplo, en I_0 el tiempo de aceleración t_b de 0 a 3000 rpm es:

$$t_b [s] = \frac{3000 \cdot 2\pi}{M_0 \cdot 60s} \cdot \frac{m^2}{10^4 \cdot cm^2} \cdot J \quad \text{con } M_0 \text{ en Nm y } J \text{ en kgcm}^2$$

Constante térmica de tiempo t_{th} [min]

La constante t_{th} indica el tiempo de calentamiento del motor frío, con una carga de I_0 , hasta alcanzar una sobretensión de $0,63 \times 105$ Kelvin. Este aumento de temperatura se produce en mucho menos tiempo si el motor está cargado con la corriente máxima.

Tiempo de retardo de liberación t_{BRH} [ms] / Tiempo de retardo de activación t_{BRL} [ms] del freno

Estas constantes indican los tiempos de respuesta del freno de retención cuando funciona con la tensión nominal del servoamplificador.

U_N

Tensión nominal de la red

U_n

Tensión de la conexión del bus de CC. $U_n = \sqrt{2} \cdot U_N$

--- / ---

5 Français

5.1 Généralités	116
5.1.1 À propos de ce manuel	116
5.1.2 Abréviations utilisées	116
5.1.3 Symboles utilisés	116
5.2 Sécurité	117
5.2.1 Votre attention est requise pour ce chapitre	117
5.2.2 Utilisation recommandée	119
5.2.3 Utilisation interdite	119
5.2.4 Manipulation	120
5.3 Colis	122
5.3.1 Livraison	122
5.3.2 Plaque signalétique	122
5.3.3 Description des numéros de modèles AKM2G	123
5.4 Description technique	128
5.4.1 Caractéristiques techniques générales	128
5.4.2 Caractéristiques standard	129
5.4.3 Technologie de câblage	133
5.4.4 Frein de maintien	134
5.5 Installation mécanique	135
5.5.1 Remarques importantes	135
5.6 Installation électrique	136
5.6.1 Remarques importantes	136
5.6.2 Guide d'installation électrique	137
5.6.3 Raccordement des moteurs à l'aide des câbles préassemblés	137
5.7 Mise en service	138
5.7.1 Remarques importantes	138
5.7.2 Guide de configuration	139
5.7.3 Dépannage	140
5.8 Définition des termes pour les caractéristiques techniques	141

5.1 Généralités

5.1.1 À propos de ce manuel

Ce manuel décrit la AKM@2G gamme de servomoteurs synchrones (versions standard / basse tension). Ces moteurs sont utilisés dans des systèmes de variateur avec des Kollmorgen servo-amplificateurs. Veuillez prendre connaissance de l'ensemble de la documentation fournie, à savoir :

- Manuel d'instructions du servo-amplificateur
- Communication par bus manuel (par ex. CANopen ou EtherCAT)
- Aide en ligne du logiciel de configuration de l'amplificateur
- Manuels régionaux des accessoires
- Description technique de la AKM2G gamme de moteurs







Pour plus d'informations, rendez-vous sur le site du Kollmorgen réseau de développeurs, à l'adresse kdn.kollmorgen.com.

5.1.2 Abréviations utilisées

NOTE

Les abréviations utilisées pour les caractéristiques techniques sont décrites dans le chapitre "Définition des termes" → p. 141. Dans ce document, la symbolique (→ # 53) signifie : "voir page 53".

5.1.3 Symboles utilisés

Symbole	Description
 DANGER	Indique une situation dangereuse qui, faute de prendre les mesures adéquates, entraînera des blessures graves, voire mortelles.
 AVERTISSEMENT	Indique une situation dangereuse qui, faute de prendre les mesures adéquates, peut entraîner des blessures graves, voire mortelles.
 ATTENTION	Indique une situation dangereuse qui, faute de prendre les mesures adéquates, peut entraîner des blessures assez graves ou légères.
NOTICE	Indique des situations qui, faute de prendre les mesures adéquates, peuvent entraîner des dommages matériels.
NOTE	Ce symbole signale des remarques importantes.
	Avertissement d'un danger (général). Le type de danger concerné est indiqué dans le texte à côté du symbole.
	Avertissement d'un danger lié à l'électricité et ses effets.
	Avertissement d'un danger lié à une surface chaude.
	Avertissement d'un danger lié à des charges suspendues.

5.2 Sécurité

Cette section a pour but de vous aider à identifier et éviter les dangers, tant pour les personnes que pour le matériel.

5.2.1 Votre attention est requise pour ce chapitre

Personnel spécialisé

Seul un personnel dûment qualifié est autorisé à effectuer des opérations de transport, de montage, de configuration et de maintenance. Par personnel qualifié, on entend toute personne familiarisée avec le transport, l'installation, le montage, la mise en service et l'utilisation des moteurs et disposant des qualifications minimales en rapport avec ses activités :

- Transport : exclusivement réservés à un personnel possédant des connaissances en matière de manipulation de composants sensibles à l'électricité statique.
- Installation mécanique : exclusivement réservée à des mécaniciens.
- Installation électrique : exclusivement réservée à des électriciens.
- Configuration : exclusivement réservée à des spécialistes de l'électrotechnique et des technologies d'entraînement.

Le personnel qualifié doit connaître et respecter les normes CEI 60364 / CEI 60664, ainsi que les réglementations nationales en matière de prévention des accidents.

Lecture de la documentation

Lisez la documentation disponible avant l'installation et la mise en service. Toute manipulation incorrecte du moteur peut provoquer des blessures ou des dégâts. L'opérateur doit donc s'assurer que toutes les personnes travaillant sur le moteur ont lu et compris le manuel et appliquent les consignes de sécurité qui y sont énoncées.

Prise en compte des caractéristiques techniques

Respectez les caractéristiques techniques et les spécifications relatives aux conditions de connexion (plaque signalétique et documentation). Le dépassement des valeurs de tension ou d'intensité autorisées peut entraîner des dommages sur les moteurs, par exemple en raison d'une surchauffe.

Évaluation des risques

Le fabricant de l'appareil doit procéder à une évaluation des risques pour celui-ci et prendre les mesures appropriées afin d'éviter tout dommage corporel ou matériel provoqué par un éventuel mouvement inopportun. Des exigences supplémentaires concernant le personnel spécialisé peuvent également découler de l'évaluation des risques.

Transport sécurisé

Soulevez et déplacez les moteurs de plus de 20 kg (AKM2G7) uniquement à l'aide d'engins de levage. Un levage sans assistance peut provoquer des blessures au dos. Respectez toujours les consignes fournies : [Transport](#)

Mise en sécurité de la clavette

Retirez toute clavette éventuellement présente sur l'arbre avant de laisser le moteur fonctionner à vide sans charge couplée afin d'éviter toute situation dangereuse en cas de projection de la clavette due à la force centrifuge. À la livraison, la clavette est protégée par un capuchon plastique.

Surface chaude



Les surfaces des moteurs peuvent être très chaudes pendant le fonctionnement, conformément à leur catégorie de protection. Risque de brûlures mineures La température de surface peut dépasser 100 °C. Mesurez la température et attendez que le moteur ait refroidi en dessous de 40 °C avant de le toucher.

Mise à la terre Hautes tensions



Assurez-vous de la mise à la terre correcte du boîtier du moteur avec la barre omnibus PE de l'armoire de commande comme potentiel de référence. Risque de choc électrique. Aucune protection personnelle ne peut être garantie sans mise à la terre de faible impédance ; tout choc électrique peut entraîner la mort.

L'absence de signalétique ne garantit pas l'absence de tension. Les connexions d'alimentation peuvent être sous tension, même si l'arbre du moteur ne tourne pas.

Ne débranchez aucun connecteur pendant le fonctionnement. Toucher des contacts exposés peut entraîner des blessures graves, voire la mort. Les connexions d'alimentation peuvent être sous tension, même lorsque l'arbre du moteur ne tourne pas. Des arcs électriques peuvent alors se former, et endommager les contacts et occasionner des blessures.

Après avoir déconnecté le servo-amplificateur de la source de tension d'alimentation, attendez plusieurs minutes avant de toucher des composants habituellement sous tension (par ex. contacts, connexions à vis) ou d'ouvrir un connecteur.

Les condensateurs du servo-amplificateur peuvent encore présenter une tension dangereuse plusieurs minutes après la coupure des tensions d'alimentation. Pour éviter tout risque, mesurez la tension de la liaison c.c. et attendez qu'elle chute sous 60 V.

Fixation des charges suspendues



Les freins de maintien intégrés ne garantissent pas la sécurité fonctionnelle ! L'utilisateur doit respecter les normes de sécurité locales en vigueur en cas de suspension de charges (axes verticaux) et assurer la sécurité du personnel en prenant des mesures de sécurité supplémentaires destinées à éviter les risques.

5.2.2 Utilisation recommandée

- Le joint d'arbre en AKM2G gamme de servomoteurs synchrones a été spécifiquement conçue pour l'entraînement de robots industriels, de machines-outils, de machines textiles, d'équipements d'emballage et d'autres machines similaires soumises à des exigences dynamiques élevées.
- L'utilisation des moteurs est uniquement autorisée dans les conditions ambiantes définies dans la présente documentation.
- Le joint d'arbre en AKM2G gammes de moteurs est **exclusivement** destinée à être commandée par des servo-amplificateurs, avec régulation de la vitesse et/ou du couple.
- Les moteurs sont installés en tant que composants dans des machines ou des équipements électriques et ne peuvent être exploités et mis en service qu'en tant que composants intégrés de ces équipements ou machines.
- Le capteur thermique intégré aux enroulements du moteur doit être surveillé et évalué.
- Les freins de maintien sont conçus pour faire office de freins d'arrêt et ne se prêtent pas à des freinages opérationnels répétés.
- La conformité du servosystème aux normes indiquées dans la déclaration de conformité CE [Approvals](#) n'est garantie que si les composants utilisés (servo-amplificateur, moteur, câbles, etc.) ont été fournis par Kollmorgen.

5.2.3 Utilisation interdite

- L'utilisation des **Norme** standard est interdite
 - directement sur les réseaux d'alimentation secteur,
 - dans les zones présentant un risque d'explosion,
 - en cas de contact avec des denrées alimentaires et des boissons,
 - dans les environnements impliquant des acides caustiques et/ou conducteurs, des bases, des huiles, des vapeurs ou des poussières.
- La mise en service du moteur est interdite si la machine sur laquelle il est installé :
 - ne satisfait pas aux exigences de la directive européenne "Machines",
 - ne satisfait pas aux exigences de la directive CEM,
 - ne satisfait pas aux exigences de la directive "Basse tension".
- Afin de garantir la sécurité fonctionnelle, les freins de maintien intégrés ne peuvent jamais être utilisés seuls sans équipement supplémentaire.

5.2.4 Manipulation

5.2.4.1 Transport

- Classe climatique 2K3 selon la norme CEI 60721-3-2, EN61800-2
- Température : -25 à +70 °C, variations max. 20 K/heure
- Humidité : humidité relative 5 à 95 %, sans condensation
- Uniquement par du personnel qualifié, dans l'emballage recyclable d'origine du fabricant.
- Évitez les chocs, en particulier au niveau du bout d'arbre.
- Si l'emballage est abîmé, vérifiez si le moteur présente des dommages visibles. Informez-en le transporteur et, le cas échéant, le fabricant.

Transport de moteurs de plus de 20 kg

Il convient d'utiliser des œillets de levage pour transporter AKM2Gles moteurs 7 (> 20 kg) en toute sécurité. Observez les instructions de transport accompagnant le moteur, le cas échéant.

Nous vous recommandons d'utiliser l'outil de transport ZPZM 120/292 pour déplacer les moteurs.

L'unité de suspension ZPMZ 120/292 se compose d'une barre, à suspendre au crochet de la grue, et de deux chaînes de suspension doubles.



DANGER

Charge suspendue. Danger de mort en cas de chute de la charge. Ne passez jamais sous la charge lorsque le moteur est en cours de levage.

- Les vis de fixation des œillets de levage doivent être serrées à fond.
- Les œillets de levage doivent reposer à plat sur la surface de support.
- Avant de commencer le levage, vérifiez que les œillets de levage sont solidement fixés et qu'ils ne présentent aucun dommage apparent (corrosion, déformation).
- N'utilisez plus les œillets de levage s'ils sont déformés.

B1/ 4 x Lifting Bolt Plus Lifting Beam

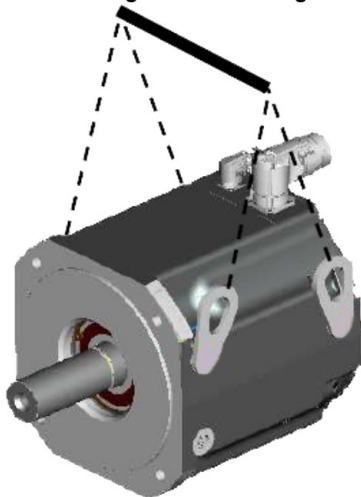

B2/ 2 x Lifting Bolt Plus Lifting Beam

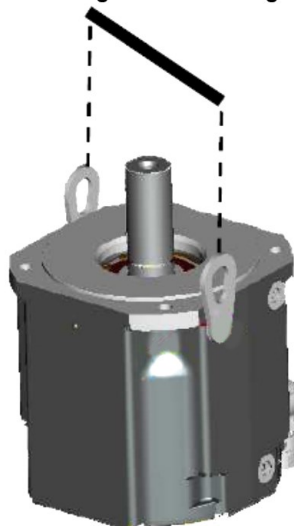

B3/ 2 x Lifting Bolt Plus Lifting Beam

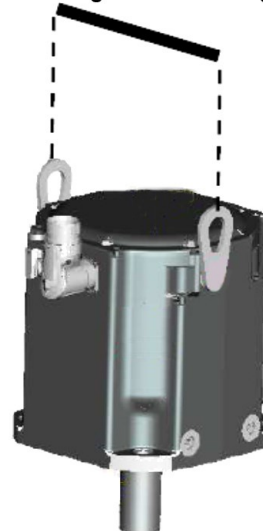

5.2.4.2 Emballage

- Emballage en carton avec mousse Instapak®.
- Vous pouvez renvoyer au fournisseur les éléments en plastique (voir section "Mise au rebut").

Type de moteur	Emballage	Hauteur max. d'empilage
AKM2G2	Carton	10
AKM2G3	Carton	6
AKM2G4	Carton	6
AKM2G5	Carton	5
AKM2G6	Carton	1
AKM2G7	Carton	1

5.2.4.3 Stockage

- Classe climatique 1K4 selon la norme CEI 60721-3-1, EN61800-2
- Température de stockage : - 25 à +55 °C, max. variations max. 20 K/heure
- Humidité : humidité relative 5 à 95 %, sans condensation
- Le stockage doit être effectué uniquement dans l'emballage d'origine recyclable du fabricant.
- Hauteur max. d'empilage : voir tableau au chapitre "Emballage"
- Durée de stockage : illimitée

5.2.4.4 Maintenance / Nettoyage

- La maintenance et le nettoyage ne peuvent être effectués que par du personnel qualifié.
- Les roulements à bille doivent être remplacés au bout de 20 000 heures de service dans des conditions nominales (définies par le fabricant).
- Vérifiez l'absence de bruit inhabituel au niveau des roulements du moteur toutes les 2 500 heures de service ou chaque année. En présence de bruits suspects, cessez d'utiliser le moteur et faites remplacer les roulements par le fabricant.
- L'ouverture du moteur annule la garantie.
- Si le boîtier du moteur est sale, procédez à un nettoyage à l'isopropanol ou équivalent, mais n'immergez pas le moteur et ne pulvérisez aucun produit dessus.

5.2.4.5 Réparation / Mise au rebut

Toute intervention de réparation sur le moteur doit être effectuée par le fabricant. L'ouverture du moteur annule la garantie. Conformément à la directive DEEE 2012/19/CE, nous reprenons les appareils et accessoires usagés à des fins de mise au rebut professionnelle pour autant que les coûts de transport soient pris en charge par l'expéditeur. Retournez le moteur à l'adresse :

Kollmorgen s.r.o.

Attn.: Repair Department

Evropska 864

664 42 Modrice / République tchèque

E-mail : brno_customer_repairs@kollmorgen.com

Téléphone : +420 533 314 455

5.3 Colis

5.3.1 Livraison

- Moteur de la AKM2G gamme
- Manuel d'utilisation du produit (multilingue) en version imprimée, un seul exemplaire par colis

5.3.2 Plaque signalétique

Sur les moteurs standard, une plaque signalétique autocollante est apposée sur le côté du boîtier.

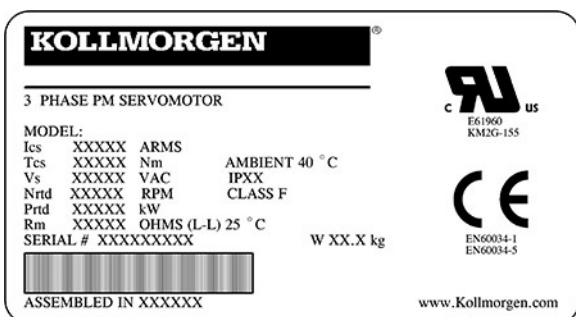
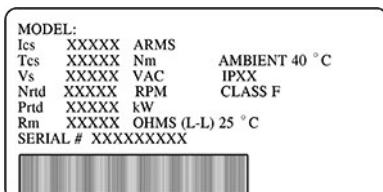

Légende	Description
MODELE	Type de moteur
Ics	(courant d'arrêt)
Tcs	(couple d'arrêt)
Vs	U_N (tension d'alimentation)
Nrtd	nn (vitesse nominale à U_N)
Prtd	Pn (puissance nominale)
Rm	R25 (résistance de l'enroulement à 25°)
PORT	N° de série
AMBIENT	Température ambiante maximum
W	Poids du moteur en kg
IPXX	Indice de protection
CLASS F	Classe d'isolation

L'année de fabrication est codée dans le numéro de série : les deux premiers chiffres du numéro de série correspondent à l'année de fabrication (par ex. 17 = 2017).

5.3.3 Description des numéros de modèles AKM2G

5.3.3.1 Tableau des références

Utilisez le tableau des références uniquement à des fins d'identification des produits et non pour le traitement des commandes, car toutes les combinaisons théoriques de fonctionnalités ne sont pas possibles.

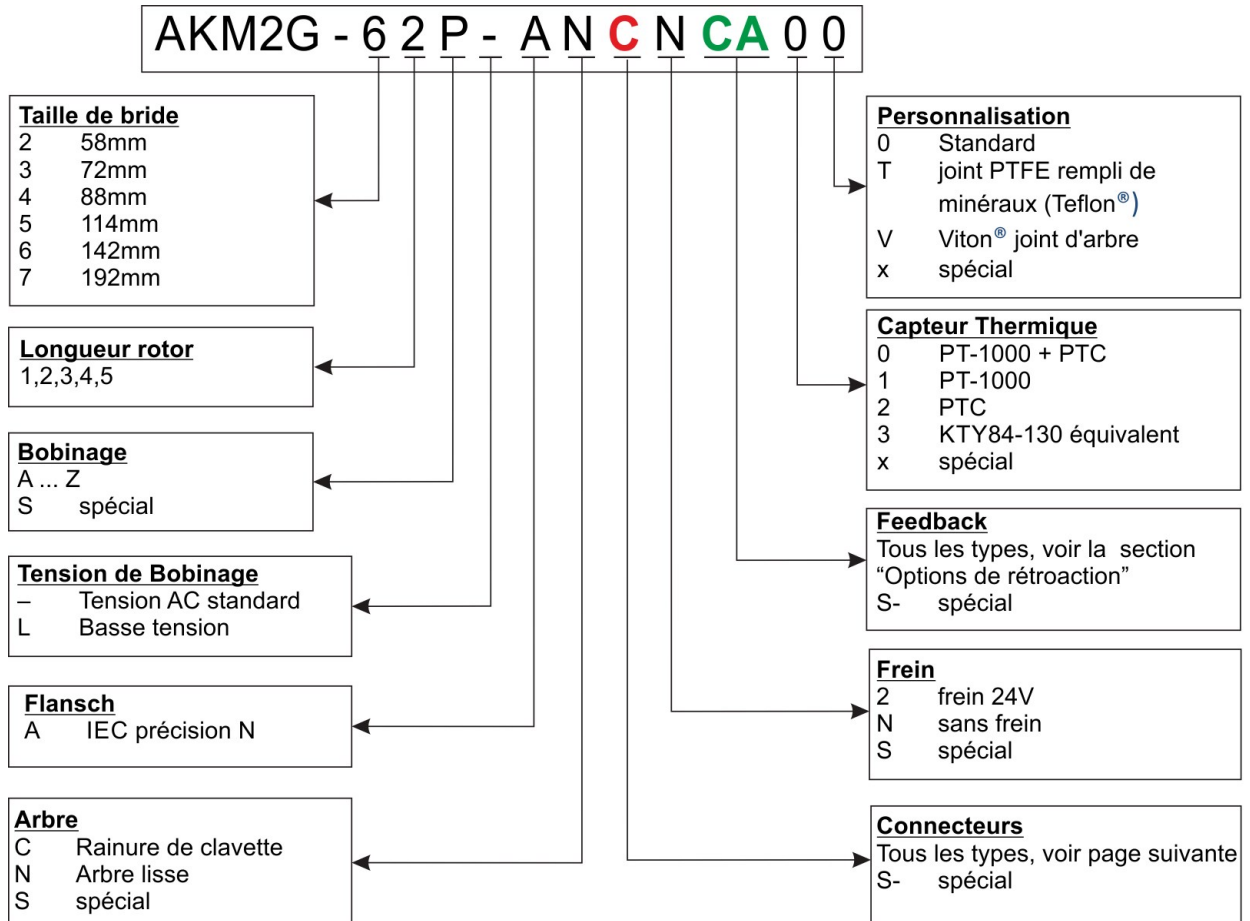

5.3.3.2 Options de connexion (C)

Les brochages des différentes options de connexion sont présentés au chapitre "Brochage des connecteurs" [Connector Pinout](#).

5.3.3.3.1 Description du connecteur

Connecteur	Usage*	Contacts - Broches Puissance/ Signal	Déplacement Courant [A] Puissance/ Signal	Déplacement transversale Section [mm ²] Puissance/ Signal	Indice de protection	Câble Power d'alimentation Taille (mm ²)	Connecteur homologué suggéré
Connecteurs à angle droit SpeedTec M23 (taille 1)	Alimentation et freinage	4 / 5	20 / 10	4 / 1,5	IP65	1,5	BSTA-082-FR-46-58-0100-000
						2,5	BSTA-082-FR-46-58-0100-000
						4,0	BSTA-082-FR-32-59-0100-000
	Résolveur	- / 12	- / 10	- / 0,5	IP65	-	ASTA-013-FR-01-62-0100-000
	Codeur	- / 17	- / 10	- / 0,5	IP65	-	ASTA-014-FR-01-61-0100-000
	Hybride (SFD3)	4 / 5	20 / 10	4 / 1,5	IP65	1,5	BSTA-082-FR-46-58-0100-000
						2,5	BSTA-082-FR-46-58-0100-000
						4,0	BSTA-082-FR-32-58-0100-000
	Hybride (DSL)	4 / 5	20 / 10	4 / 1,5	IP65	1,5	H51A-425-FR-14-58-0100-000 + 40.A711.00
						2,5	H51A-425-FR-14-58-0100-000 + 40.A711.00
						4,0	H51A-425-FR-15-59-0100-000 + 40.A711.00
	Hybride (EnDat)	4 / 5	20 / 10	4 / 1,5	IP65	1,5	H51A-405-FR-14-59-0100-000 + 40.A702.00
						4,0	H51A-405-FR-15-59-0100-000 + 40.A702.00

Connecteur	Usage*	Contacts - Broches Puissance/ Signal	Déplacement Courant [A] Puissance/ Signal	Déplacement transversale Section [mm ²] Puissance/ Signal	Indice de protection	Câble Power d'alimentation Taille (mm ²)	Connecteur homologué suggéré
M40 (Taille 1,5)	Alimentation et freinage	4 / 5	75 / 30	16 / 4	IP65	4,0	CSTA-265-FR-06-26-0020-000
						6,0	CSTA-265-FR-06-25-0020-000
						10,0	CSTA-265-FR-06-25-0020-000
	Hybride (SFD3)	4 / 5	75 / 30	16 / 4	IP65	4,0	CSTA-265-FR-06-26-0020-000
						6,0	CSTA-265-FR-06-25-0020-000
						10,0	CSTA-265-FR-06-25-0020-000
	Hybride (DSL)	4 / 5	75 / 30	16 / 4	IP65	4,0	H81A-501-FR-03-44-0100-000 + 40.A711.00
						6,0	H81A-501-FR-03-45-0100-000 + 40.A711.00
	y-tec	Alimentation et freinage	4 / 5	14 / 3,6	1,5 / 0,75	IP65	1,5
Rétroaction		- / 12	- / 5	- / 0,75	IP65		ESTB-002-FR-02-32-0001-000

Hybride (SFD3) désigne un connecteur associant alimentation et rétroaction SFD3 (+ freinage), sur un seul câble.

Hybride (DSL) désigne un connecteur associant alimentation et rétroaction DSL (+ freinage), sur un seul câble.

Hybride (EnDat) désigne un connecteur associant alimentation et rétroaction EnDat (+ freinage), sur un seul câble.

5.3.3.4.2 Désignation du connecteur - Moteur

Désignation du modèle	Connecteur	Utilisable avec	Position du connecteur
C	2 connecteurs Speedtec M23	AKM2G3 - AKM2G7 ≤ 20 A	Coudé, orientable, monté sur le moteur
D*	1 connecteur hybride M23	AKM2G2 - AKM2G7 ≤ 20 A	Coudé, orientable, monté sur le moteur
G	2 connecteurs Speedtec M23	AKM2G3 - AKM2G7 ≤ 20 A	Droit, monté sur le moteur
H	1 connecteur d'alimentation M40, 1 connecteur de rétroaction M23	AKM2G7 > 20 A	Coudé, orientable, monté sur le moteur
J*	1 connecteur hybride M40	AKM2G7 > 20 A	Coudé, orientable, monté sur le moteur
Y	1 connecteur Y-Tec	AKM2G2	Orientable, monté sur le moteur

* Les connecteurs hybrides sont valides pour SFD3, DSL et EnDat uniquement.

5.3.3.5 Options de rétroaction (CA)

La longueur du moteur dépend du dispositif de rétroaction intégré, reportez-vous aux schémas dimensionnels, [Dimension drawings](#).

Aucune installation ultérieure n'est possible. Les brochages des différentes options de connexion sont présentés dans [Connector Pinout](#).

5.3.3.6.1 Description du dispositif de rétroaction

Code	Description	Prise en charge Assistance 3	Précision 1,2 (seconde d'arc)	Bruit efficace 1 (seconde d'arc)	Remarques	Résolution	Mouvement absolu absolue	Variateurs Variateurs	Prise en charge Sécurité Assistance 4
CA	SFD3	Oui	±585"	±9,9"	Inductif	24 bits	1	Gamme AKD	Non
GU	Hiperface DSL	Oui	±240"	±20"	Capacitif	17 bits	4 096	Gamme AKD	jusqu'à SIL2 7,9
LD 5	EnDat 2.2	Oui	±120"	Voir remarque 6 ci-dessous	Inductif	19 bits	4 096	Gamme AKD	jusqu'à SIL310
			±65"						
R-	Résolveur	Non	±540"	N/A	Inductif	24 bits pour AKD	1	Tous	Non
2- 8	Codeur de commutation	Non	+/- 218,2"	N/A	Optique	12 bits	Néant	Gamme AKD	

1. Les variateurs AKD ont une précision de mesure du résolveur de ±45", pour un variateur avec un précision de moteur de ±585" et un bruit efficace de ±9,9".
2. La précision désigne la précision globale du système une fois installé dans le moteur. Le bruit désigne le bruit de positionnement efficace à l'arrêt.
3. La prise en charge de l'ID moteur signifie que les données de la plaque signalétique du moteur électronique sont incluses, permettant une mise en service Plug-and-Play.
4. Classe SIL de l'appareil tel que fourni par le fabricant du dispositif de rétroaction. Le client est responsable de l'évaluation de la sécurité fonctionnelle de la machine.
5. Pour les moteurs de rétroaction EnDat, l'accélération du moteur est limitée à $\leq 1 \cdot 10^5$ rad/s². Le servovariateur connecté peut limiter davantage cette valeur.
6. Ces informations n'étaient pas disponibles au moment de l'impression. Contactez Kollmorgen le service client pour obtenir des informations récentes.
7. Pour les moteurs portant les numéros de série 1935100001 ou ultérieurs.
8. Disponible uniquement sur les moteurs basse tension AKM2G3 et supérieurs.
9. Consultez le site Web du fabricant (lien ci-dessous) pour obtenir des informations spécifiques concernant les spécifications de sécurité fonctionnelle de ce dispositif de rétroaction. La section « Paramètres liés à la sécurité » contient des informations spécifiques sur les caractéristiques de sécurité du produit. D'autres sections fournissent des détails supplémentaires.
www.sick.com/us/en/motor-feedback-systems/motor-feedback-systems-rotary-hiperface-dsl/eeseem37/eem37-2kf0a017a/p/p486170
Les informations et les liens du site Web sont à jour à la date de publication de ce manuel. Vous pouvez également rechercher le produit n° 1067125 sur le site.
10. Pour des informations spécifiques concernant les spécifications de sécurité fonctionnelle de ce dispositif de rétroaction, consultez le site Web du fabricant ci-dessous.
www.heidenhain.com/en_US/products/rotary-encoders/without-integral-bearing/
Sur cette page, sélectionnez le lien du document approprié pour le dispositif de rétroaction utilisé dans le AKM2G.

AKM2G Taille	N° de modèle du fabricant	Informations générales sur la sécurité	Informations spécifiques au modèle
taille de bâti 2-4	EQI 1131	pages 28-29	pages 72-75
taille de bâti 5-7	EQI 1331	pages 28-29	pages 78-79

Les informations et les liens du site Web sont à jour à la date de publication de ce manuel. Vous pouvez également rechercher le numéro de modèle ci-dessus sur le site.

5.3.3.7.2 Options de connexion disponibles suivant le dispositif de rétroaction choisi

SFD3

Type de connecteur	compatible AKM2Gx	Type
D	AKM2G2-4	Taille 15
D	AKM2G5-7 ≤ 20 A	Taille 21
J	AKM2G7 > 20 A	Taille 21

Hiperface DSL

Type de connecteur	compatible AKM2Gx	Type
D	AKM2G2-7 ≤ 20 A	EEM37
J	AKM2G7 > 20 A	EEM37

EnDat 2.2

Type de connecteur	compatible AKM2Gx	Type
D	AKM2G2-4	EQI 1131
D	AKM2G5-7 ≤ 20 A	EQI 1331

Résolveur

Type de connecteur	compatible AKM2Gx	Type
Y	AKM2G2	Taille 15
C / G	AKM2G3-4	Taille 15
C / G	AKM2G5-7 ≤ 20 A	Taille 21
H	AKM2G7 > 20 A	Taille 21

Codeur de commutation

Type de connecteur	compatible AKM2Gx	Type
C / G	AKM2G3-4	Taille 15

5.4 Description technique

5.4.1 Caractéristiques techniques générales

Température ambiante (aux valeurs nominales)	+5 à +40 °C pour une altitude d'installation jusqu'à 1 000 m au-dessus du niveau de la mer Il est indispensable de contacter notre département Applications pour des températures ambiantes supérieures à 40 °C et pour le montage antidéflagrant des moteurs.
Humidité admissible (aux valeurs nominales)	95 % d'humidité relative, sans condensation
Réduction de puissance (courants et couples)	1 %/K entre 40 et 50 °C, jusqu'à 1 000 m au-dessus du niveau de la mer Pour une altitude d'installation supérieure à 1 000 m au-dessus du niveau de la mer et à 40 °C 6 % jusqu'à 2 000 m au-dessus du niveau de la mer 17% jusqu'à 3000m au-dessus du niveau de la mer 30% jusqu'à 4000m au-dessus du niveau de la mer 55% jusqu'à 5000m au-dessus du niveau de la mer Aucune réduction de puissance pour les altitudes d'installation supérieures à 1 000 m au-dessus du niveau de la mer avec une réduction de température de 10 K/1 000 m
Durée de vie des roulements à billes	≥ 20 000 heures de service

NOTE

Les caractéristiques techniques spécifiques à chaque type de moteur sont présentées au chapitre "Caractéristiques techniques", [Technical Data](#).

5.4.2 Caractéristiques standard

5.4.2.1 Forme de construction

La forme de base des AKM2G moteurs est la forme de construction IM B5, conformément à la norme EN 60034-7.

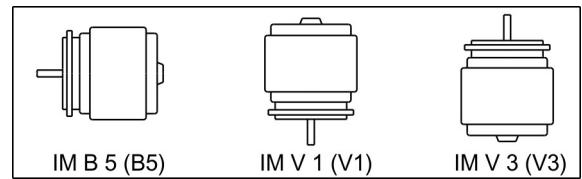

5.4.2.2 Bride

Précision de la bride CEI selon la norme DIN 42955. Tolérances de faux-rond du bout d'arbre et des brides de montage pour les machines électriques tournantes.

Code	Bride
A	CEI avec précision N, ajustement AKM2G2-7 : j6

5.4.2.3 Indice de protection

Conformément à la norme EN 60529.

Moteur standard	Option de connexion	Joint d'arbre	Indice de protection
AKM2G2-AKM2G7	C, D, G, H, J, Y	sans	IP54
AKM2G2-AKM2G7	C, D, G, H, J, Y	avec	IP65

5.4.2.4 Classe d'isolation

Le matériau d'isolation des moteurs correspond à la classe F selon la norme CEI 60085 (UL1446 classe F).

5.4.2.5 Surface

Les moteurs sont pourvus d'un revêtement par poudre époxy de couleur noir mat. Cette finition ne résiste pas aux solvants (par ex. trichloroéthylène, diluants nitro ou équivalents).

5.4.2.6 Bout d'arbre, côté A

La transmission de puissance s'effectue via le bout d'arbre cylindrique A, ajustement k6 selon la norme EN 50347, à l'aide d'un filetage de blocage, mais **sans rainure de clavette**.

Les moteurs sont également disponibles avec une rainure de clavette et une clavette intégrée, conformément à la norme DIN 6885. L'arbre avec rainure de clavette est équilibré par une (demi-)clavette courte.

La durée de vie du roulement est calculée sur 20 000 heures de service.

Code de commande	Bout d'arbre	Disponible pour
N	Arbre lisse	AKM2G 2-7
C	Rainure de clavette, fermée	AKM2G 2-7

Force radiale

Si l'entraînement du moteur s'effectue via des pignons ou des courroies crantées, des forces radiales élevées seront produites. Les valeurs admissibles en bout d'arbre sont indiquées dans les diagrammes du chapitre "Schémas", [Dimension drawings](#). Les valeurs maximum à vitesse nominale figurent dans les

caractéristiques techniques, [Technical Data](#). La prise de force au centre de l'extrémité libre de l'arbre engendre une augmentation de 10 % de la force_p.

Force axiale

Lors du montage de pignons ou de roues sur l'axe et en cas d'utilisation de réducteurs angulaires, des forces axiales sont générées. Les valeurs maximum à vitesse nominale figurent dans les caractéristiques techniques.

Accouplement

Les pinces de serrage double cône s'avèrent idéales comme dispositifs d'accouplement sans jeu, éventuellement en combinaison avec des accouplements à soufflet métallique. Orifice de centre d'arbre selon la norme DIN 332 forme D.

5.4.2.7 Joint d'arbre

Si AKM2G est raccordé à une bride de machine présentant une zone d'arbre non étanche, le joint d'arbre (option "T" ou "V") garantit l'étanchéité de l'arbre.

- L'option "T" est un joint en PTFE à charge minérale (Teflon®) auto-lubrifiant. Elle est recommandée pour les applications dans lesquelles une lubrification régulière de l'arbre n'est pas possible.
- L'option "V" est un joint en Viton®. Elle est recommandée pour les applications impliquant une lubrification régulière du joint d'arbre, telles que les boîtes d'engrenages lubrifiées.
- Le joint d'arbre garantit une protection IP65 pour la zone d'arbre.
- Les performances nominales sont atteintes au bout de quelques heures de rodage du joint d'arbre. Aucune procédure de rodage spéciale n'est requise.
- Une légère expansion du matériau du joint d'arbre (notamment le Téflon®) est normale et n'affecte pas sa fonctionnalité.
- Le joint d'arbre est pré-lubrifié avec de la graisse.

5.4.2.8 Dispositif de protection

La version standard à courant alternatif de chaque moteur est équipée d'un élément PT-1000 à isolation électrique + PTC. La version basse tension de chaque moteur est équipée d'un élément PT-1000 à isolation électrique. Les capteurs thermiques n'offrent aucune protection contre les surcharges importantes et de courte durée.

Le moteur peut être fourni avec PT-1000 +PTC, PT-1000, PTC ou des capteurs équivalents KTY 84-130 en option (voir [Options de dispositif thermique : graphiques résistance/température](#) options 0, 1, 2 et 3).

Avec les systèmes de rétroaction numériques SFD3 (CA), Hiperface DSL (GU) et EnDat 2.2 (LD), l'état du capteur de température est transmis de façon numérique et évalué par le variateur.

En cas d'utilisation de nos câbles de rétroaction configurés, le capteur est intégré au système de surveillance des servo-amplificateurs numériques.

5.4.2.9.1 Options de dispositif thermique : graphiques résistance/température

Les courbes de l'option de dispositif thermique indiquent la résistance équivalente en ohms qui correspond à une température donnée des enroulements du moteur. Le variateur utilisé avec le moteur doit prendre en charge le dispositif thermique sélectionné pour garantir un bon fonctionnement.

Option de dispositif thermique 0

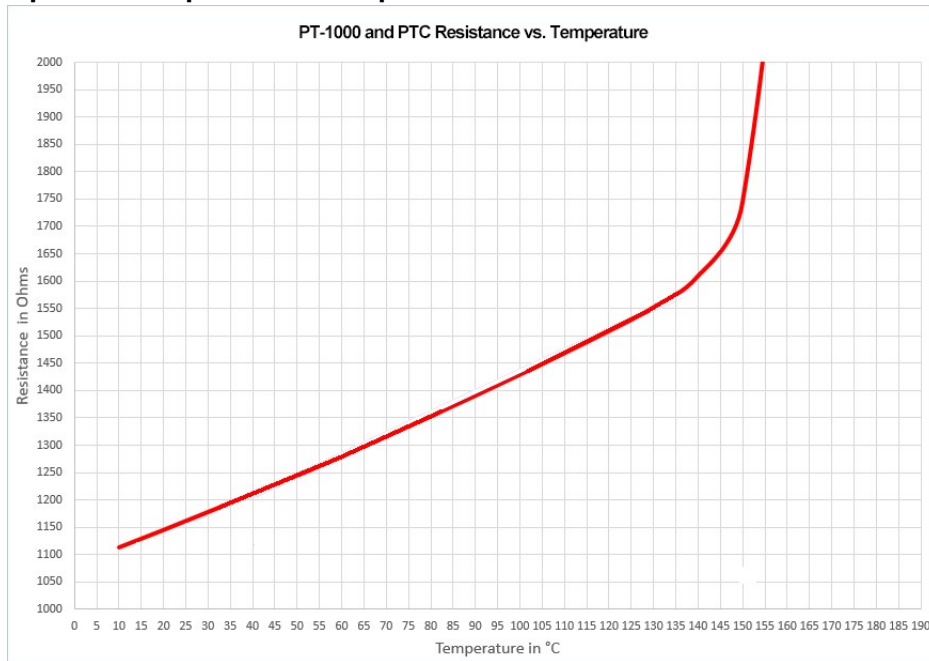

Option de dispositif thermique 1

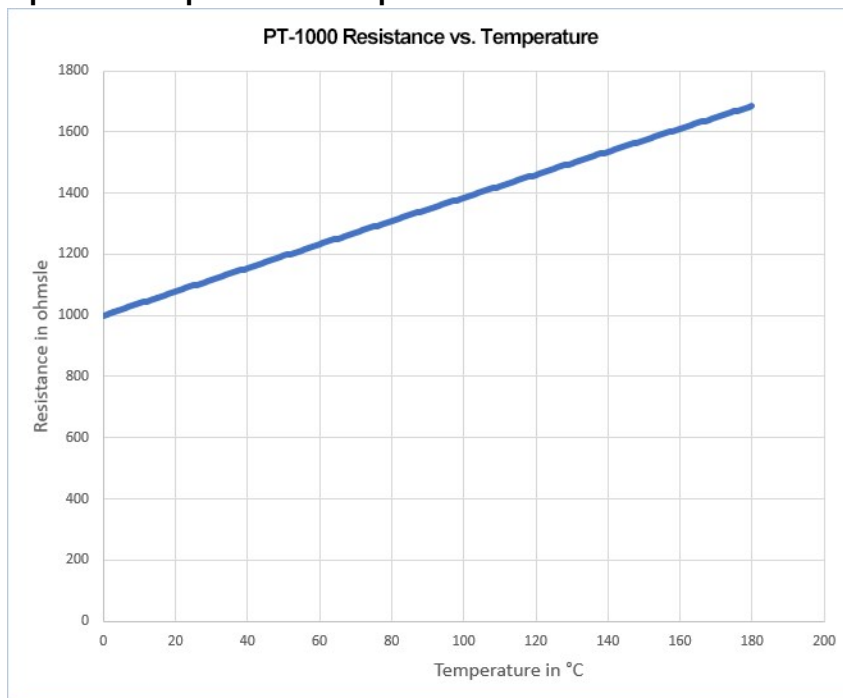

Option de dispositif thermique 2

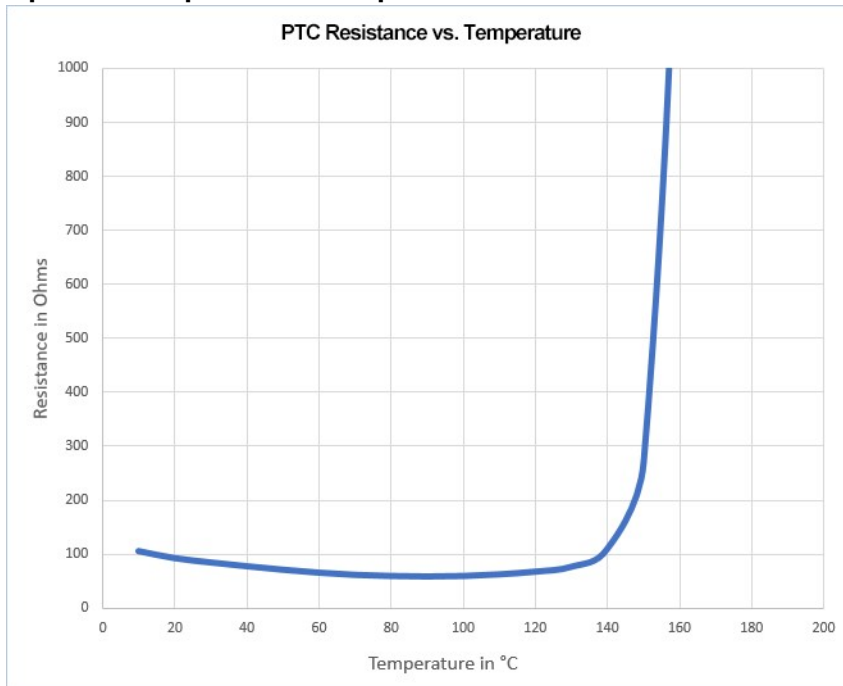

Option de dispositif thermique 3

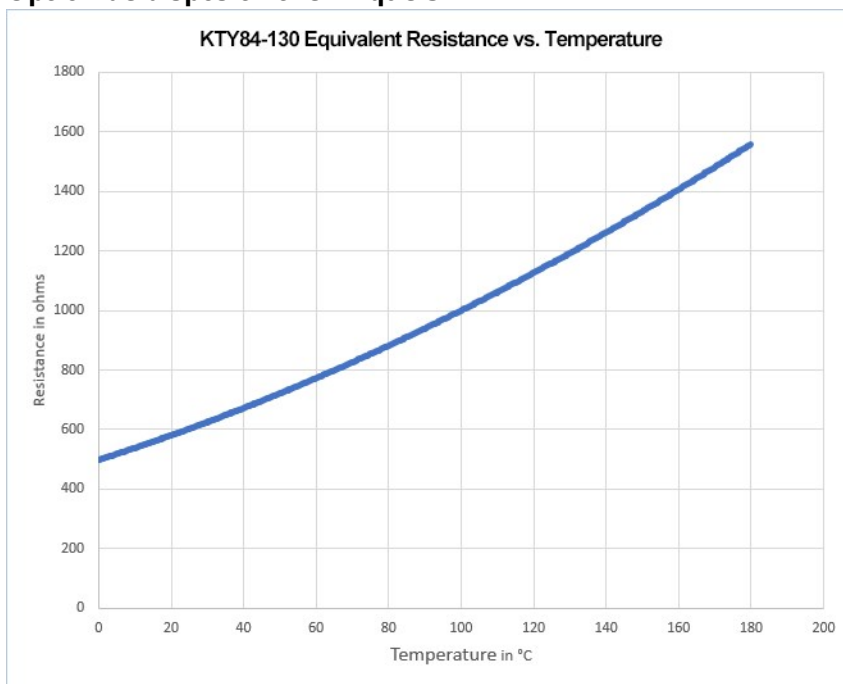

5.4.2.10 Classe de vibrations

Les moteurs sont conçus avec une classe de vibration A selon la norme EN 60034-14. Pour une plage de vitesses comprise entre 600 et 3 600 tr/min et un centre d'arbre situé entre 56 et 132 mm, la valeur réelle du niveau de vibrations admissible est de 1,6 mm/s.

Vitesse [tr/min]	Déplacement vibratoire relatif max. [μm]	Faux-rond max. [μm]
$\leq 1\ 800$	90	23
$> 1\ 800$	65	16

5.4.3 Technologie de câblage

5.4.3.1 Connecteurs

Description des connecteurs disponibles : [Options de connexion \(C\)](#). Brochage des connecteurs : à partir de [Connector Pinout](#).

5.4.3.2 Sections de câble

(Sections de câble pour une température ambiante de 40 °C.)

Câble d'alimentation, câble combiné

Les câbles combinés comportent quatre lignes d'alimentation et deux lignes supplémentaires pour la commande du frein de maintien du moteur.

Section		Intensité maximale admissible	Remarques
Câble	Câble combiné		
(4x1)	(4x1+(2x0,75))	0 A < I ₀ rms ≤ 10,1 A	Les parenthèses (...) indiquent le blindage. Intensité maximale admissible selon la norme EN60204-1:2006 Tableau 6, colonne B2
(4x1,5)	(4x1,5+(2x0,75))	10,1 A < I ₀ rms ≤ 13,1 A	
(4x2,5)	(4x2,5+(2x1))	13,1 A < I ₀ rms ≤ 17,4 A	
(4x4)	(4x4+(2x1))	17,4 A < I ₀ rms ≤ 23 A	
(4x6)	(4x6+(2x1))	23 A < I ₀ rms ≤ 30 A	
(4x10)	(4x10+(2x1,5))	30 A < I ₀ rms ≤ 40 A	
(4x16)	(4x16+(2x1,5))	40 A < I ₀ rms ≤ 54 A	
(4x25)	(4x25+(2x1,5))	54 A < I ₀ rms ≤ 70 A	

Câble de rétroaction

Type	Section	Remarques
Résolveur	(4x2x0,25)	
Codeur	(4x2x0,25)	

Câble hybride

Type	Section	Remarques
SFD3/DSL	(4x1,0+(2x0,34)+(2x0,75))	4 lignes d'alimentation, 2 lignes de freinage et 2 lignes de signal pour SFD3/DSL 6 lignes de signal pour EnDat 2.2
SFD3/DSL	(4x1,5+(2x0,34)+(2x0,75))	
SFD3/DSL	(4x2,5+(2x0,34)+(2x1,0))	
SFD3/DSL	(4x4,0+(2x0,34)+(2x1,0))	
SFD3/DSL	(4x6,0+(2x0,34)+(2x1,0))	
EnDat 2.2	(4x1,5 + (2x0,75) + (2x (2x0,14) + (2x0,25)))	
EnDat 2.2	(4x4,0 + (2x1,0) + (2x (2x0,14) + (2x0,25)))	

5.4.4 Frein de maintien

Tous les moteurs peuvent être équipés en option d'un frein de maintien. Un frein à ressort (24 V c.c.) est intégré aux moteurs. Lorsqu'il n'est plus sous tension, ce frein bloque le rotor.



AVERTISSEMENT

En présence d'une charge suspendue (axes verticaux), le frein de maintien du moteur est desserré et, au même moment, le variateur ne génère plus aucune sortie : la charge risque de tomber ! Il existe un risque de blessure pour le personnel d'exploitation de la machine. L'utilisateur doit respecter les normes de sécurité locales en vigueur en cas de suspension de charges (axes verticaux) et assurer la sécurité du personnel en prenant des mesures de sécurité supplémentaires destinées à éviter les risques.

NOTICE

Les freins de maintien sont conçus pour faire office de freins d'arrêt et ne se prêtent pas à des freinages opérationnels répétés. Dans le cas de freinages opérationnels fréquents, une usure prématurée et une défaillance du frein de maintien sont à prévoir.

La longueur du moteur augmente lors du montage d'un frein de maintien.

Le frein de maintien peut être commandé directement par le servo-amplificateur (sans sécurité personnelle !), l'enroulement est démagnétisé dans le servo-amplificateur ; aucun circuit supplémentaire n'est requis (cf. manuel d'instructions du servo-amplificateur). Si le frein de maintien n'est pas commandé directement par le variateur, un câblage supplémentaire (par ex. varistance) est requis. Contactez notre service d'assistance.

Les caractéristiques techniques du frein sont présentées dans le chapitre "Caractéristiques techniques du frein", [Technical Data Brakes](#).

5.5 Installation mécanique

NOTE Les schémas dimensionnels sont disponibles au chapitre "[Dimension drawings](#)".

5.5.1 Remarques importantes

NOTE Seul un personnel qualifié disposant des connaissances nécessaires en génie mécanique est autorisé à procéder au montage du moteur.

- Protégez le moteur contre toute contrainte inacceptable. Lors du transport et de la manutention, veillez à n'endommager aucun composant.
- Le site doit être exempt de matériaux conducteurs ou corrosifs. Pour un montage V3 (bout d'arbre orienté vers le haut), assurez-vous qu'aucun liquide ne puisse pénétrer dans les roulements.
- Assurez-vous que la ventilation du moteur n'est pas gênée ou obstruée et observez les valeurs admissibles de température ambiante et de bride. Pour des températures ambiantes supérieures à 40 °C, contactez notre département Applications au préalable. Veillez à un transfert de chaleur correct aux alentours et au niveau de la bride du moteur.
- La bride et l'arbre du moteur sont particulièrement vulnérables lors du stockage et du montage. Évitez donc de forcer sur les composants. Il est important d'utiliser le filetage de blocage fourni pour serrer les accouplements, les roues dentées et les poulies, ainsi que de préchauffer les composants du variateur si possible. Évitez les coups ou l'usage d'une force excessive, qui peuvent endommager les roulements et l'arbre.

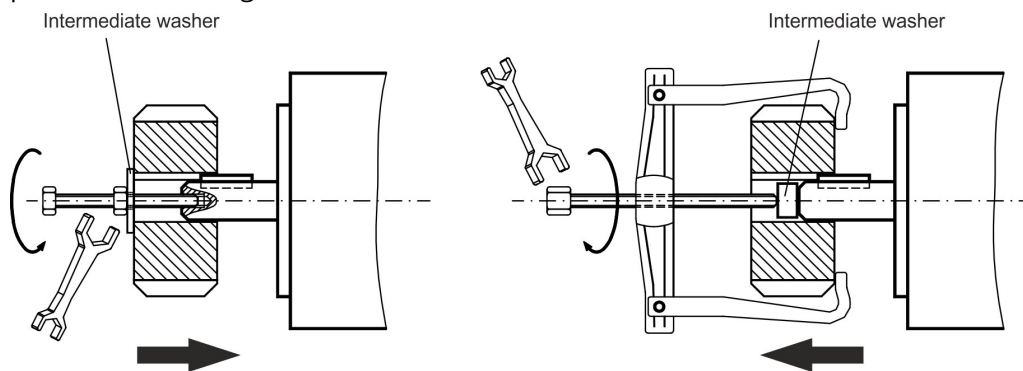

- Si possible, utilisez uniquement des accouplements ou des pinces de serrage sans jeu et à friction. Veillez à l'alignement correct des accouplements. Tout décalage engendrera des vibrations inacceptables et la destruction des roulements et de l'accouplement.
- Dans tous les cas, n'effectuez pas un montage sous contrainte mécanique de l'arbre du moteur en utilisant un accouplement rigide avec des roulements externes supplémentaires (par ex., dans une boîte de vitesses).
- Prenez note du nombre de pôles du moteur et de celui du résolveur (le cas échéant) et veillez à effectuer un réglage correct au niveau du servo-amplificateur utilisé. En effet, un réglage incorrect peut entraîner la destruction du moteur, notamment pour les moteurs de petite taille.
- Évitez si possible les charges axiales sur l'arbre moteur. L'application de charges axiales réduit considérablement la durée de vie du moteur.
- Vérifiez la conformité vis-à-vis des forces F_R et F_A . En cas d'utilisation d'un variateur à courroie crantée, le diamètre minimum admissible du pignon par exemple, doit correspondre à l'équation suivante : $d_{\min} \geq (M_0/F_R)*2$

5.6 Installation électrique

NOTE

Les brochages des différents connecteurs sont présentés au chapitre "Brochage des connecteurs", [Connector Pinout](#). Le brochage de l'extrémité du servo-amplificateur est présenté dans le manuel d'instructions correspondant.

5.6.1 Remarques importantes

NOTE

Seul un personnel qualifié et dûment formé en électrotechnique est autorisé à procéder au câblage du moteur.



DANGER

Assurez-vous toujours que les moteurs ne sont plus sous tension lors de toute opération de montage et de câblage. Les éventuels équipements à raccorder ne doivent pas être mis sous tension.

Toucher des contacts exposés peut entraîner des blessures graves, voire la mort. Assurez-vous que l'alimentation de l'armoire de commande reste coupée (barrière, panneaux d'avertissement, etc.). Les différentes tensions ne seront remises en circuit qu'au moment de l'installation.

Ne débranchez jamais les connexions électriques du moteur pendant qu'il est sous tension. Risque de choc électrique. Dans certaines circonstances défavorables, des arcs électriques peuvent se produire, ce qui peut endommager les contacts et provoquer des blessures.

Une tension dangereuse découlant de la charge résiduelle peut encore être présente au niveau des condensateurs jusqu'à 10 minutes après la coupure de l'alimentation secteur. Les câbles de commande et d'alimentation peuvent encore être sous tension, même lorsque le moteur ne tourne pas.

Mesurez la tension de la liaison c.c. et attendez qu'elle chute sous 60 V.

NOTE

Le symbole de masse , présent sur les schémas de raccordement, indique que vous devez assurer une connexion conductrice sur la surface la plus vaste possible entre l'unité spécifiée et la plaque de fixation dans l'armoire de commande. Cette connexion permet de supprimer les interférences HF. Elle ne doit pas être

confondue avec le symbole PE (protective earth, terre de protection)  (mesure de protection selon la norme EN 60204).

Pour effectuer le câblage du moteur, reportez-vous aux schémas de câblage fournis dans le manuel d'installation et de configuration du servo-amplificateur utilisé.

5.6.2 Guide d'installation électrique

- Vérifiez que le servo-amplificateur et le moteur sont adaptés l'un à l'autre. Comparez la tension et l'intensité nominales de l'unité. Effectuez le câblage conformément au schéma de câblage fourni dans le manuel d'instructions du servo-amplificateur. Les connexions au moteur sont présentées dans le chapitre "Brochage des connecteurs", [Connector Pinout](#).
- Posez tous les câbles de courant forte avec une section adéquate, conformément à la norme EN 60204. La section recommandée figure dans les caractéristiques techniques.

NOTE

Dans le cas de câbles moteur longs (> 25 m) et suivant le type de servo-amplificateur utilisé, il convient de raccorder une inductance moteur au câble moteur (cf. manuel d'instructions du servo-amplificateur et manuel des accessoires).

- Assurez-vous que le servo-amplificateur et le moteur sont correctement mis à la terre. Utilisez un dispositif de mise à la terre et de blindage CEM approprié, conformément au manuel d'instructions du servo-amplificateur utilisé. Mettez à la terre la plaque de fixation et le boîtier du moteur.
- Si le câble d'alimentation moteur utilisé comprend des fils de commande de frein intégrés, ces fils doivent être blindés. Le blindage doit être raccordé aux deux extrémités (cf. manuel d'instructions du servo-amplificateur).
- Câblage :
 - Acheminez les câbles d'alimentation aussi loin que possible des câbles de commande.
 - Raccordez le dispositif de rétroaction.
 - Raccordez les câbles moteur, posez les inductances moteur (le cas échéant), fermez l'amplificateur.
 - Raccordez les blindages aux bornes de blindage ou aux connecteurs CEM aux deux extrémités.
 - Raccordez le frein de maintien, le cas échéant.
 - Raccordez le blindage aux deux extrémités.
- Raccordez tous les blindages via un contact de grande surface (faible impédance) et des boîtiers de connecteurs métallisés ou des presse-étoupes CEM.
- Exigences relatives au câblage :

Capacité électrique

Câble moteur : inférieure à 150 pF/m

Câble de rétroaction : inférieure à 120 pF/m

5.6.3 Raccordement des moteurs à l'aide des câbles préassemblés

- Effectuez le câblage conformément aux normes et réglementations en vigueur.
- Utilisez uniquement Kollmorgen des câbles blindés préassemblés pour les connexions du résolveur et de l'alimentation.
- Une installation incorrecte du blindage entraînera des interférences CEM et nuira au bon fonctionnement du système.
- La longueur de câble maximum est indiquée dans le manuel d'instructions du servo-amplificateur utilisé.

NOTE

Pour une description détaillée des câbles configurés, reportez-vous au manuel des accessoires régional.

5.7 Mise en service

5.7.1 Remarques importantes

NOTE

Seul un personnel spécialisé disposant de connaissances approfondies dans le domaine de l'électrotechnique et de la technologie d'entraînement est autorisé à mettre en service l'unité de variateur du servo-amplificateur et du moteur.



DANGER

Présence possible de tensions mortelles, jusqu'à 900 V. Risque de choc électrique. Vérifiez que tous les points de raccordement sous tension sont sécurisés et protégés contre tout contact accidentel.

Ne débranchez jamais les connexions électriques du moteur pendant qu'il est sous tension. Risque de choc électrique. La charge résiduelle des condensateurs du variateur peut générer des tensions dangereuses, jusqu'à 10 minutes après la coupure de l'alimentation secteur.

Les câbles de commande et d'alimentation peuvent encore être sous tension, même lorsque le moteur ne tourne pas. Mesurez la tension de la liaison c.c. et attendez qu'elle chute sous 60 V.



ATTENTION

La température de surface du moteur peut dépasser 100 °C en fonctionnement. Risque de brûlures légères ! Vérifiez (mesurez) la température du moteur. Attendez qu'il ait refroidi en dessous de 40 °C avant de le toucher.



ATTENTION

Le variateur est susceptible d'effectuer des mouvements inattendus lors de la phase de mise en service.

Assurez-vous que le personnel et les équipements à proximité ne puissent pas subir de blessures/dommages dans une telle éventualité.

Les mesures à prendre à cet égard dans le cadre de vos attributions reposent sur l'évaluation des risques de l'application donnée.

5.7.2 Guide de configuration

La procédure de configuration est donnée à titre d'exemple. Une procédure différente peut s'avérer judicieuse ou nécessaire, selon l'utilisation prévue pour les appareils.

1. Vérifiez le montage et l'orientation du moteur.
2. Vérifiez que les composants du variateur (embrayage, boîte à engrenages, poulie à courroie) sont correctement mis en place et réglés (respectez les forces radiales et axiales admissibles).
3. Vérifiez le câblage et les connexions du moteur et du servo-amplificateur. Vérifiez que la mise à la terre est correcte.
4. Testez le fonctionnement du frein de maintien, le cas échéant (Appliquez une tension de 24 V, le frein doit être relâché).
5. Vérifiez que le rotor du moteur tourne librement (relâchez le frein si nécessaire). Écoutez pour détecter tout bruit de grincement.
6. Vérifiez que toutes les mesures nécessaires ont été prises afin d'éviter tout contact accidentel avec des pièces sous tension ou en mouvement.
7. Effectuez les éventuels tests nécessaires, tels que requis spécifiquement pour votre système.
8. Mettez ensuite en service le variateur conformément aux instructions fournies pour le servo-amplificateur.
9. Dans les systèmes multi-axe, mettez en service individuellement chaque variateur (amplificateur et moteur).

5.7.3 Dépannage

Le tableau ci-dessous doit être considéré comme un "kit de premier secours". Chaque défaillance peut avoir de nombreuses causes différentes, suivant les conditions d'utilisation particulières de votre système. Les causes de panne décrites ci-dessous sont principalement celles qui influencent directement le moteur. Les spécificités qui se présentent dans le comportement de la boucle de commande peuvent généralement être attribuées à une erreur de paramétrage du servo-amplificateur. La documentation du servo-amplificateur et le logiciel de configuration fournissent des informations à ce sujet.

Dans les systèmes multi-axe, les défaillances peuvent avoir d'autres causes cachées.

Erreur	Cause possible	Solutions
Le moteur ne tourne pas	<ul style="list-style-type: none"> — Servo-amplificateur non activé — Rupture du câble de point de consigne — Séquence des phases moteur incorrecte — Frein pas desserré — Blocage mécanique du variateur 	<ul style="list-style-type: none"> — Fournissez un signal d'activation (ENABLE) — Vérifiez le câble de point de consigne — Corrigez la séquence des phases moteur — Vérifiez les commandes de frein — Vérifiez le mécanisme
Le moteur s'emballé	<ul style="list-style-type: none"> — Séquence des phases moteur incorrecte 	<ul style="list-style-type: none"> — Corrigez la séquence des phases moteur
Le moteur vibre	<ul style="list-style-type: none"> — Blindage du câble de rétroaction endommagé — Gain de l'amplificateur trop élevé 	<ul style="list-style-type: none"> — Remplacez le câble de rétroaction — Restaurez les valeur par défaut du moteur
Message d'erreur : frein	<ul style="list-style-type: none"> — Court-circuit au niveau du câble de tension d'alimentation du frein de maintien moteur — Frein de maintien du moteur défectueux 	<ul style="list-style-type: none"> — Éliminez le court-circuit — Remplacez le moteur
Message d'erreur : étage de sortie défectueux	<ul style="list-style-type: none"> — Court-circuit ou défaut à la terre au niveau du câble moteur — Court-circuit ou défaut à la terre au niveau du moteur 	<ul style="list-style-type: none"> — Remplacez le câble — Remplacez le moteur
Message d'erreur : rétroaction	<ul style="list-style-type: none"> — Connecteur de rétroaction mal branché — Rupture du câble de rétroaction, écrasement du câble ou autre dommage 	<ul style="list-style-type: none"> — Vérifiez le connecteur — Vérifiez les câbles
Message d'erreur : température du moteur	<ul style="list-style-type: none"> — Capteur thermique du moteur déclenché — Connecteur de rétroaction desserré ou rupture du câble de rétroaction 	<ul style="list-style-type: none"> — Attendez que le moteur ait refroidi. Déterminez ensuite la cause de la température élevée du moteur. — Vérifiez le connecteur et remplacez le câble de rétroaction si nécessaire
Le frein ne serre pas	<ul style="list-style-type: none"> — Couple de maintien requis trop élevé — Frein défectueux — Surcharge axiale de l'arbre moteur 	<ul style="list-style-type: none"> — Vérifiez le dimensionnement — Remplacez le moteur — Vérifiez la charge axiale, réduisez-la. Remplacez le moteur, étant donné que les roulements ont été endommagés.

5.8 Définition des termes pour les caractéristiques techniques

NOTE

Les caractéristiques techniques spécifiques à chaque type de moteur figurent au chapitre "Caractéristiques techniques" [Technical Data](#).

Toutes les données sont validées pour une température ambiante de 40 °C et une surtempérature de l'enroulement de 100 K. Détermination des données nominales avec une température constante de 65 °C au niveau de la bride d'adaptation. Les données peuvent présenter une tolérance de +/- 10 %.

Couple d'arrêt M_0 [Nm]

Le couple d'arrêt peut être maintenu indéfiniment à un régime de $0 < n < 100$ tr/min et aux conditions ambiantes nominales.

Couple nominal M_n [Nm]

Le couple nominal est délivré lorsque le moteur consomme le courant nominal au régime nominal. Il peut être produit indéfiniment au régime nominal en service continu (S1).

Courant d'arrêt I_{0rms} [A]

Le courant d'arrêt est le courant sinusoïdal efficace que le moteur consomme à $0 < n < 100$ tr/min pour produire le couple d'arrêt.

Courant de crête (courant impulsionnel) I_{0max} [A]

Le courant de crête (valeur sinusoïdale efficace) est égal à plusieurs fois le courant nominal, suivant l'enroulement du moteur. La valeur réelle est déterminée par le courant de crête du variateur utilisé.

Constante de couple K_{Trms} [Nm/A]

La constante de couple définit le couple (en Nm) produit par le moteur avec un courant de 1 A eff. La relation est $M = I \times K_T$.

Constante de tension K_{Erms} [mV/min-1]

La constante de tension définit la force électromotrice induite du moteur sous forme de valeur sinusoïdale efficace entre deux bornes, pour 1 000 tr/min. Valeur mesurée à 25 °C.

Moment d'inertie du rotor J [kgcm²]

La constante J est une mesure de la capacité d'accélération du moteur. Par exemple, à I_0 le temps d'accélération t_b de 0 à 3 000 tr/min est donné par :

$$t_b [s] = \frac{3000 \cdot 2\pi}{M_0 \cdot 60s} \cdot \frac{m^2}{10^4 \cdot cm^2} \cdot J \quad \text{avec } M_0 \text{ exprimé en Nm et } J \text{ en kgcm}^2$$

Constante de temps thermique t_{th} [min]

La constante t_{th} définit le temps employé par le moteur froid, sous une charge de I_0 , pour chauffer à une surtempérature de $0,63 \times 105$ Kelvin. Cette hausse de température a lieu dans un délai bien plus court en cas de charge du moteur avec le courant de crête.

Délai d'attente de desserrage t_{BRH} [ms]/ Délai d'attente de serrage t_{BRL} [ms] du frein

Ces constantes définissent les temps de réaction du frein de maintien lorsqu'il est alimenté avec la tension nominale du servo-amplificateur.

U_N

Tension d'alimentation secteur nominale

U_n

Tension de la liaison de bus c.c. $U_n = \sqrt{2} \cdot U_N$

--- / ---

6 Русский

6.1 Общие сведения	144
6.1.1 О настоящем руководстве	144
6.1.2 Используемые сокращения	144
6.1.3 Используемые символы	144
6.2 Безопасность	145
6.2.1 Необходимо обратить внимание на следующее	145
6.2.2 Использование по назначению	147
6.2.3 Запрещенное использование	147
6.2.4 Эксплуатация	148
6.3 Упаковка	150
6.3.1 Комплект поставки	150
6.3.2 Заводская табличка	150
6.3.3 Описание номера модели AKM2G	151
6.4 Техническое описание	156
6.4.1 Общие технические характеристики	156
6.4.2 Стандартные функции	156
6.4.3 Технология монтажа	161
6.4.4 Удерживающий тормоз	162
6.5 Механический монтаж	163
6.5.1 Важные замечания	163
6.6 Электрический монтаж	164
6.6.1 Важные замечания	164
6.6.2 Руководство по электрическому монтажу	165
6.6.3 Подсоединение электродвигателей с предварительно собранными кабелями	165
6.7 Настройка	166
6.7.1 Важные замечания	166
6.7.2 Руководство по пусконаладке	167
6.7.3 Устранение неисправностей	168
6.8 Термины и определения для технических данных	170

6.1 Общие сведения

6.1.1 О настоящем руководстве

Данное руководство описывает АКМ®2G серию синхронных серводвигателей (стандартного/низковольтного исполнения). Электродвигатели работают в приводных системах вместе с Kollmorgen сервоусилителями. Соблюдайте требования, изложенные во всей прилагаемой к системе документации, а именно:

- Руководство по эксплуатации сервоусилителя
- Руководство по связи по шине (например, CANopen или EtherCAT)
- Онлайн-справка по установочному ПО усилителя
- Руководство по региональному дополнительному оборудованию
- Техническое описание АКМ2G серии электродвигателей

Дополнительная исходная информация содержится на Kollmorgen портале разработчиков по адресу kdn.kollmorgen.com.

6.1.2 Используемые сокращения

NOTE

Сокращения, используемые в технических данных, приведены в главе «Термины и определения» → р. 170. В настоящем документе символ (→ # 53) означает: см. стр. 53.

6.1.3 Используемые символы

Символ	Индикация
 ОПАСНО	Указывает на опасную ситуацию, которая, не будучи предотвращенной, приведет к тяжелым травмам, в том числе со смертельным исходом.
 ПРЕДУПРЕЖДЕНИЕ	Указывает на опасную ситуацию, которая, не будучи предотвращенной, может привести к тяжелым травмам, в том числе со смертельным исходом.
 ВНИМАНИЕ	Указывает на опасную ситуацию, которая, не будучи предотвращенной, может привести к травмам низкой и средней тяжести.
NOTICE	Указывает на ситуации, которые, не будучи предотвращенными, могут привести к повреждению оборудования.
NOTE	Этот символ обозначает важные указания.
	Предупреждение об опасности (общее). Тип опасности определяется сопроводительным текстом к символу.
	Предупреждение об опасности электричества и его эффектов.
	Предупреждение об опасности касания горячей поверхности.
	Предупреждение о подвешенных грузах.

6.2 Безопасность

Этот раздел поможет распознавать и предотвращать опасности для сотрудников и оборудования.

6.2.1 Необходимо обратить внимание на следующее

Следует обратиться к специалисту!

К выполнению таких задач, как транспортировка, монтаж, настройка и техническое обслуживание, допускается только квалифицированный персонал. Квалифицированными специалистами считаются лица, имеющие опыт транспортировки, установки, монтажа, пуско-наладочных работ и эксплуатации электродвигателей и обладающие минимально достаточной квалификацией для выполнения своих обязанностей:

- Транспортировка: только персонал, умеющий работать с компонентами, чувствительными к электростатическому разряду.
- Механический монтаж: только персонал, имеющий навыки работы с механическим оборудованием.
- Электрический монтаж: только персонал, имеющий навыки работы с электрооборудованием.
- Настройка: только персонал, имеющий основательные навыки работы с электрооборудованием и приводами

Квалифицированный персонал должен знать и соблюдать требования стандартов IEC 60364 / IEC 60664, а также национальных правил по предотвращению несчастных случаев.

Прочитайте документацию!

Прочитайте доступную документацию перед монтажом и вводом в эксплуатацию. Неправильное обращение с электродвигателем может стать причиной травм или повреждения оборудования. Оператор обязан обеспечить изучение руководства всеми сотрудниками, которые будут работать с двигателем, проверку усвоенных знаний и соблюдение правил техники безопасности, изложенных в данном руководстве.

Обратите внимание на технические характеристики!

Придерживайтесь технических данных и спецификаций при выборе условий подключения (заводская табличка и документация). Превышение допустимых значений напряжения или тока может привести к повреждению электродвигателей, например, вследствие перегрева.

Выполните оценку рисков!

Производитель машины должен произвести оценку рисков для машины и принять соответствующие меры, исключая возможность нанесения травм или повреждений имущества вследствие непредвиденных движений машины. По результатам оценки рисков к специалистам могут быть предъявлены дополнительные требования.

Принимайте меры безопасности при транспортировке!

Поднимайте и транспортируйте электродвигатели массой свыше 20 кг (AKM2G7) только с помощью подъемных приспособлений. Несоблюдение этого правила может привести к травме спины. Строго соблюдайте указания на [Транспортировка](#)

Удалите шпонки!

Снимите все вставленные шпонки (при наличии) с вала, прежде чем запустить двигатель без сопряженной нагрузки, чтобы избежать опасного разлета шпонок под действием центробежных сил. При поставке шпонка закрыта пластмассовой заглушкой.

Горячая поверхность!



Поверхности электродвигателей при работе могут нагреваться до очень высокой температуры, в соответствии со своей категорией защиты. Опасность ожогов низкой степени! Температура поверхности может превышать 100°C. Измерьте температуру и дождитесь охлаждения электродвигателя до температуры ниже 40°C перед тем, как прикоснуться к нему.

Выполните заземление! Высокое напряжение!



Очень важно убедиться в том, что корпус электродвигателя надежно заземлен на РЕ-шине (защитное заземление) в распределительном шкафу. Опасность поражения электрическим током. В отсутствие низкоомного заземления невозможно гарантировать защиту персонала, и существует риск поражения электрическим током с летальным исходом.

Отсутствие индикации не гарантирует отсутствие напряжения. Напряжение в проводах может сохраняться даже тогда, когда вал двигателя не вращается.

Не отключайте любые разъемы во время эксплуатации. Прикосновение к оголенным контактам чревато тяжелыми травмами, в том числе со смертельным исходом. Напряжение в проводах может сохраняться даже тогда, когда вал двигателя не вращается. Это может привести к искровым разрядам с последующими травмами персонала и повреждением контактов.

После отключения сервоусилителя от напряжения питающей сети выждите несколько минут, прежде чем коснуться любого из компонентов, обычно находящегося под напряжением (например, контактов, резьбовых соединений), или раскрыть любой разъем.

Конденсаторы в сервоусилителе могут оставаться под опасным напряжением в течение нескольких минут после отключения напряжения питающей сети. В качестве меры безопасности измерьте напряжение промежуточного звена и дождитесь снижения напряжения ниже 60 В.

Соблюдайте меры безопасности в отношении висящих грузов!



Встроенные тормоза не обеспечивают функциональную безопасность! Пользователь должен учитывать действующие местные стандарты безопасности при работе с висящими грузами (вертикальные оси) и необходимость обеспечения безопасности персонала, предпринимая дополнительные меры предотвращения рисков.

6.2.2 Использование по назначению

- . АКМ2G Данная серия синхронных серводвигателей разработана специально для приводов промышленных роботов, металлообрабатывающих станков, текстильного и упаковочного оборудования и иных подобных машин, предъявляющих высокие требования к динамике.
- Эксплуатация электродвигателей разрешена только в тех условиях окружающей среды, которые определены настоящей документацией.
- . АКМ2G Данная серия электродвигателей предназначена **исключительно** для работы с сервоусилителями в системах с регулированием частоты вращения и/или вращающего момента.
- Электродвигатели устанавливаются в качестве компонентов в электрооборудование или машины и могут быть введены в эксплуатацию только как составные части такого оборудования или машин.
- Необходимо контролировать и анализировать показания теплового датчика, встроенного в обмотки двигателя.
- Тормоза выполнены в виде стояночных тормозов и не рассчитаны на многократное торможение во время эксплуатации.
- Соответствие сервосистемы стандартам, упомянутым в Декларации соответствия ЕС [Approvals](#) гарантируется только при условии, что используемые компоненты (сервоусилитель, электродвигатель, кабели и т.п.) поставлены Kollmorgen.

6.2.3 Запрещенное использование

- Использование электродвигателей **Standard** запрещается
 - с подключением напрямую к электросети,
 - во взрывоопасных зонах,
 - в контакте с продуктами питания и напитками,
 - в присутствии едких и / или электропроводных кислот, щелочей, масел, паров, пыли.
- Ввод электродвигателя в эксплуатацию запрещается, если машина, в которой он установлен,
 - не соответствует требованиям Директивы ЕС по машинному оборудованию,
 - не соответствует Директиве по электромагнитной совместимости,
 - не соответствует Директиве по низковольтному оборудованию.
- Встроенные тормоза без дополнительного оборудования нельзя использовать для обеспечения функциональной безопасности.

6.2.4 Эксплуатация

6.2.4.1 Транспортировка

- Климатический класс 2K3 согласно IEC 60721-3-2, EN61800-2
- Температура: -25...+70°C, изменение макс. 20 К/ч
- Влажность: относит. влажность 5 - 95%, без конденсации
- Изделие должно транспортироваться только квалифицированным персоналом в оригинальной экологичной упаковке.
- Избегайте ударов, особенно в области конца вала
- В случае повреждения упаковки проверьте электродвигатель на отсутствие видимых повреждений. Поставьте в известность транспортную компанию и, если необходимо, изготовителя.

Транспортировка электродвигателей массой более 20 кг

Подъемные проушины следует использовать для безопасной транспортировки электродвигателей АКМ2G7 (> 20 кг). Соблюдайте все инструкции по транспортировке, вложенные в упаковку электродвигателя.

Для перемещения электродвигателей рекомендуется использовать транспортировочное приспособление ZPZM 120/292.

Подвесной модуль ZPMZ 120/292 содержит траверсу, подвешенную на крюке крана, и два двусторонних цепных подвеса.



ОПАСНОСТЬ

Подвешенный груз. Падение груза может причинить смертельные травмы. Запрещается находиться под поднятым электродвигателем.

- Крепежные винты подъемных проушин должны быть вкручены до упора.
- Подъемные проушины должны располагаться на опорной поверхности равномерно и в одной плоскости.
- Перед началом работ проверьте надежность крепления подъемных проушин и отсутствие любых видимых повреждений (коррозия, деформация).
- Запрещается использовать деформированные подъемные проушины.

B1/ 4 x Lifting Bolt Plus Lifting Beam

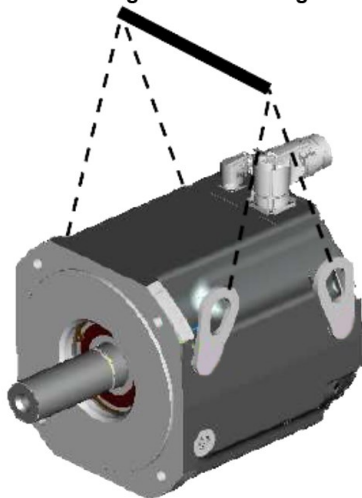

B2/ 2 x Lifting Bolt Plus Lifting Beam

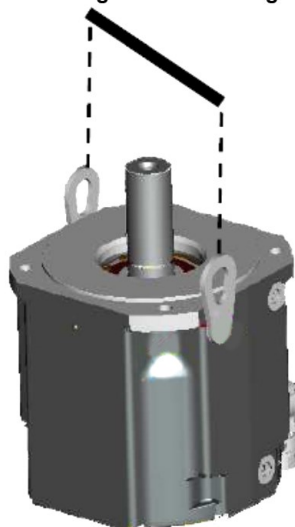

B3/ 2 x Lifting Bolt Plus Lifting Beam

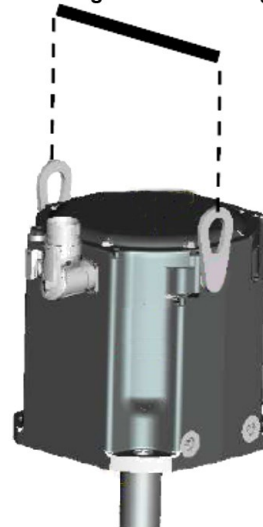

6.2.4.2 Упаковка

- Картонная упаковка с вспененной прокладкой Instapak®.
- Пластиковые детали можно вернуть поставщику (см. «Утилизация»).

Тип электродвигателя	Упаковка	Макс. высота штабеля
AKM2G2	Картонная упаковка	10
AKM2G3	Картонная упаковка	6
AKM2G4	Картонная упаковка	6
AKM2G5	Картонная упаковка	5
AKM2G6	Картонная упаковка	1
AKM2G7	Картонная упаковка	1

6.2.4.3 Хранение

- Климатический класс 1K4 согласно IEC 60721-3-1, EN61800-2
- Температура при хранении: - 25...+55°C, изменение макс. 20 К/ч
- Влажность: относит. влажность 5 - 95%, без конденсации
- Изделие должно храниться только в оригинальной упаковке
- Макс. высота штабеля: см. таблицу в главе «Упаковка»
- Срок хранения: не ограничен

6.2.4.4 Техническое обслуживание / очистка

- Техническое обслуживание и очистка выполняются только квалифицированными специалистами
- Шарикоподшипники следует заменять через 20000 часов, отработанных в номинальных условиях (заданных изготовителем).
- Проверяйте электродвигатель на отсутствие шума подшипников каждые 2500 отработанных часов, то есть ежегодно. При обнаружении любых шумов остановите электродвигатель и замените подшипники (силами изготовителя).
- Вскрытие электродвигателя приведет к потере гарантии.
- Загрязненный корпус следует очищать изопропиловым спиртом или иным подобным веществом, без погружения или распыления

6.2.4.5 Ремонт / утилизация

Ремонт электродвигателя должен выполняться изготовителем. Вскрытие электродвигателя приведет к потере гарантии. В соответствии с директивами WEEE-2012/19/ЕС мы принимаем старые устройства и дополнительное оборудование для профессиональной утилизации, при условии, что транспортные расходы несет отправитель. Направьте электродвигатель по адресу:

Kollmorgen s.r.o.

Attn.: Repair Department

Evropska 864

664 42 Modrice / Czech Republic

Эл. почта: brno_customer_repairs@kollmorgen.com

Тел.: +420 533 314 455

6.3 Упаковка

6.3.1 Комплект поставки

- Электродвигатель AKM2G серии
- Печатное руководство по эксплуатации (на нескольких языках), по 1 шт. на поставку

6.3.2 Заводская табличка

У стандартных электродвигателей заводская табличка наклеена на боковую сторону корпуса.

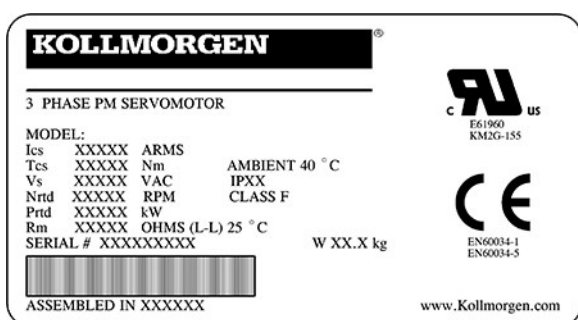
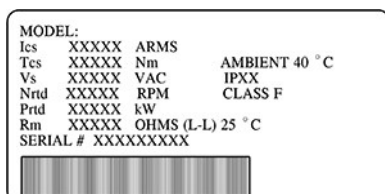

Условные обозначения	Описание
MODEL	Тип электродвигателя
Ics	Ток покоя
Tcs	Момент покоя
Vs	U _N (питающее напряжение)
Nn	пп (номинальная частота вращения при U _N)
Prtd	P _n (номинальная мощность)
Rm	R25 (сопротивление обмотки при 25°)
SERIAL	Серийный номер
AMBIENT	Макс. темп. окруж. среды
W	Масса электродвигателя в кг
IPXX	Степень защиты
CLASS F	Класс изоляции

Год производства закодирован в серийном номере: две первые цифры серийного номера обозначают год производства, например, «17» означает 2017.

6.3.3 Описание номера модели AKM2G

6.3.3.1 Таблица номеров деталей

Используйте схему номеров по каталогу только для идентификации изделия, но не для заказа, так как не все теоретические комбинации функций могут быть реализованы на практике.

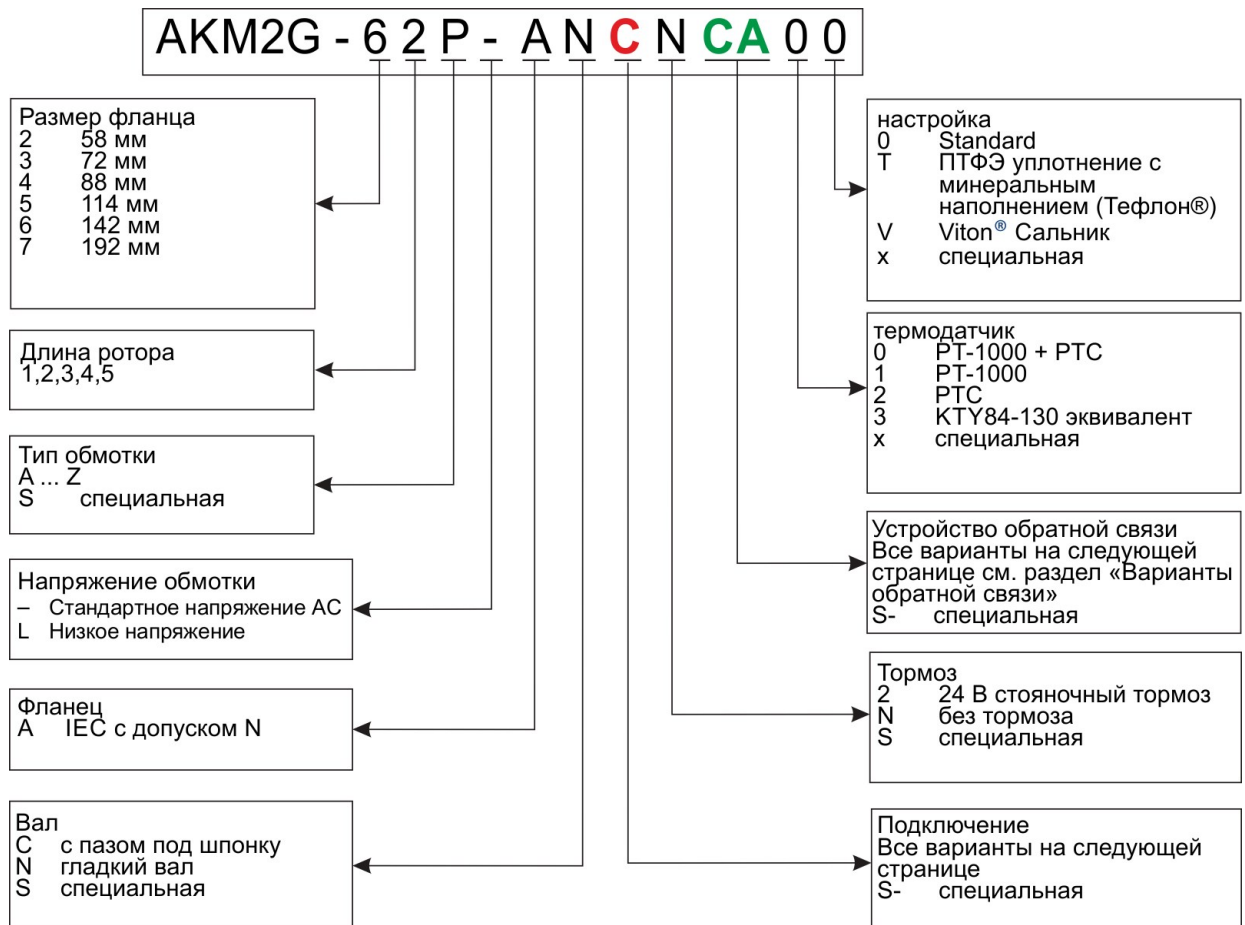

6.3.3.2 Варианты разъемов (C)

Разводка выводов для вариантов разъемов указана в главе «Разводка выводов разъемов» [Connector Pinout](#).

6.3.3.3.1 Описание разъема

разъемом	Использование*	Контакты - выходы	относительная влажность не выше Ток [А]	относительная влажность не выше Поперечное сечение [мм²]	Класс защиты	Кабель Power Провод Размер (мм²)	Рекомендуемая ответная часть разъема
		Питание/Сигнал	Питание/Сигнал	Питание/Сигнал			
Угловые разъемы M23 SpeedTec (типоразмер 1)	Питание и тормоз	4 / 5	20 / 10	4 / 1.5	IP65	1.5	BSTA-082-FR-46-58-0100-000
						2.5	BSTA-082-FR-46-58-0100-000
						4.0	BSTA-082-FR-32-59-0100-000
	Резольвер	- / 12	- / 10	- / 0.5	IP65	-	ASTA-013-FR-01-62-0100-000
	с дополнительного	- / 17	- / 10	- / 0.5	IP65	-	ASTA-014-FR-01-61-0100-000
	Hybrid (SFD3)	4 / 5	20 / 10	4 / 1.5	IP65	1.5	BSTA-082-FR-46-58-0100-000
						2.5	BSTA-082-FR-46-58-0100-000
						4.0	BSTA-082-FR-32-58-0100-000
	Hybrid (DSL)	4 / 5	20 / 10	4 / 1.5	IP65	1.5	H51A-425-FR-14-58-0100-000 + 40.A711.00
						2.5	H51A-425-FR-14-58-0100-000 + 40.A711.00
						4.0	H51A-425-FR-15-59-0100-000 + 40.A711.00
	Hybrid (EnDat)	4 / 5	20 / 10	4 / 1.5	IP65	1.5	H51A-405-FR-14-59-0100-000 + 40.A702.00
						4.0	H51A-405-FR-15-59-0100-000 + 40.A702.00

разъемом	Использование*	Контакты - выводы Питание/ Сигнал	относительная влажность не выше Ток [А] Питание/ Сигнал	относительная влажность не выше Поперечное сечение [мм²] Питание/ Сигнал	Класс защиты	Кабель Power Провод Размер (мм²)	Рекомендуемая ответная часть разъема
M40 (типоразмер 1.5)	Питание и тормоз	4 / 5	75 / 30	16 / 4	IP65	4.0	CSTA-265-FR-06-26-0020-000
						6.0	CSTA-265-FR-06-25-0020-000
						10.0	CSTA-265-FR-06-25-0020-000
	Hybrid (SFD3)	4 / 5	75 / 30	16 / 4	IP65	4.0	CSTA-265-FR-06-26-0020-000
						6.0	CSTA-265-FR-06-25-0020-000
						10.0	CSTA-265-FR-06-25-0020-000
	Hybrid (DSL)	4 / 5	75 / 30	16 / 4	IP65	4.0	H81A-501-FR-03-44-0100-000 + 40.A711.00
						6.0	H81A-501-FR-03-45-0100-000 + 40.A711.00
	y-tec	Питание и тормоз	4 / 5	14 / 3.6	1.5 / 0.75	IP65	1.5
Устройство обратной связи		- / 12	- / 5	- / 0.75	IP65		ESTB-002-FR-02-32-0001-000

Hybrid (SFD3) означает питание и обратную связь SFD3 (+ тормоз) на одном разъеме и в одном кабеле.

Hybrid (DSL) означает питание и обратную связь DSL (+ тормоз) на одном разъеме и в одном кабеле.

Hybrid (EnDat) означает питание и обратную связь EnDat (+ тормоз) на одном разъеме и в одном кабеле.

6.3.3.4.2 Обозначение разъема-электродвигатель

Обозначение модели	Разъем	Для использования	Расположение разъема
C	2 Speedtec M23	AKM2G3 - AKM2G7 ≤ 20 A	Угловой, поворотный, с установкой на электродвигатель
D*	1 Hybrid M23	AKM2G2 - AKM2G7 ≤ 20 A	Угловой, поворотный, с установкой на электродвигатель
G	2 Speedtec M23	AKM2G3 - AKM2G7 ≤ 20 A	Прямой, с установкой на электродвигатель
H	1 M40 мощность, 1 M23 обратная связь	AKM2G7 > 20 A	Угловой, поворотный, с установкой на электродвигатель
J*	1 разъем Hybrid M40	AKM2G7 > 20 A	Угловой, поворотный, с установкой на электродвигатель
Y	1 разъем y-tec	AKM2G2	Поворотный, с установкой на электродвигатель

* Разъемы Hybrid подходят только для SFD3, DSL, и EnDat.

6.3.3.5 Варианты обратной связи (CA)

Длина электродвигателя зависит от встроенного устройства обратной связи, см. размерные схемы [Dimension drawings](#).

Модернизация невозможна. Разводка выводов для вариантов разъемов указана [Connector Pinout](#).

6.3.3.6.1 Описание обратной связи

Код	Описание	Электродвигатель ID Поддержка 3	Точность 1,2 (угл.сек.)	Среднеквадратичное значение шума 1 (угл.сек.)	Примечания	Разрешение	Абсолют. оборот.	Совместимый Приводы	Функциональная Безопасность Поддержка 4
CA	SFD3	Да	±585"	±9.9"	Индуктивный	24 бит	1	Семейство АКД	Нет
GU	Hiperface DSL	Да	±240"	±20"	Емкостной	17 бит	4096	Семейство АКД	до SIL2 7,9
LD5	EnDAT 2.2	Да	±120" ±65"	См. приведенное ниже Примечание 6	Индуктивный	19 бит	4096	Семейство АКД	до SIL310
R-	Резольвер	Нет	±540"	Неприменимо	Индуктивный	24 бит для АКД	1	Все	Нет
2-8	Коммутирующий энкодер	Нет	+/- 218.2"	Неприменимо	Оптический	12 бит	нет	Семейство АКД	

1. Приводы АКД имеют точность измерения резольвера $\pm 45''$, для привода с точностью двигателя $\pm 585''$ и среднеквадратичное значение шума $\pm 9,9''$.
2. Под точностью понимают общую точность системы после установки в двигатель. Под шумом понимают среднеквадратичное значение шума в положении покоя.
3. Поддержка идентификатора двигателя означает учет параметров электронной паспортной таблички двигателя включены, что позволяет автоматизировать ввод в эксплуатацию.
4. Уровень SIL устройства в состоянии при поставке изготовителем датчика. Ответственность за уровень функциональной безопасности машины несет заказчик.
5. Для двигателей с датчиком EnDat разгон электродвигателя ограничен величиной $\leq 1 \cdot 10^5$ рад/с². Подключение сервопривода может дополнительно ограничить это значение.
6. Эта информация не была доступна на момент печати. Обратитесь Kollmorgen в службу поддержки для получения последнего обновления.
7. Для электродвигателей с серийным номером 1935100001 или больше.
8. Имеется только на низковольтных электродвигателях AKM2G типа размера 3 и выше.
9. Дополнительную информацию о параметрах функциональной безопасности этого датчика см. на сайте изготовителя (ссылка внизу). Раздел «Параметры, связанные с безопасностью» содержит конкретную информацию о характеристиках безопасности изделия. В других разделах приводятся дополнительные подробности.
www.sick.com/us/en/motor-feedback-systems/motor-feedback-systems-rotary-hiperface-dsl/eeseem37/eem37-2kf0a017a/p/p486170
Информация на сайте и ссылки действительны на момент публикации данного руководства. В качестве альтернативы см. изделие № 1067125 на сайте.
10. Дополнительную информацию о параметрах функциональной безопасности этого датчика см. на сайте изготовителя по указанному ниже адресу.
www.heidenhain.com/en_US/products/rotary-encoders/without-integral-bearing/
На этой странице выберите правильную ссылку на документацию к датчику, используемому в AKM2G.

AKM2G типоразмер	Заводской № модели	Общие указания по технике безопасности	Информация о модели
типоразмер крепления 2–4	EQI 1131	стр. 28–29	стр. 72–75
типоразмер крепления 5–7	EQI 1331	стр. 28–29	стр. 78–79

Информация на сайте и ссылки действительны на момент публикации данного руководства. В качестве альтернативы см. указанный выше номер модели на сайте.

6.3.3.7.2 Доступные варианты разъемов при выборе обратной связи

SFD3

Тип разъема	Совместимый AKM2Gx	Тип
D	AKM2G2-4	Типоразмер 15
D	AKM2G5-7 ≤ 20 A	Типоразмер 21
J	AKM2G7 > 20 A	Типоразмер 21

Hiperface DSL

Тип разъема	Совместимый AKM2Gx	Тип
D	AKM2G2-7 ≤ 20 A	EEM37
J	AKM2G7 > 20 A	EEM37

EnDAT 2.2

Тип разъема	Совместимый AKM2Gx	Тип
D	AKM2G2-4	EQI 1131
D	AKM2G5-7 ≤ 20 A	EQI 1331

Резольвер

Тип разъема	Совместимый AKM2Gx	Тип
Y	AKM2G2	Типоразмер 15
C / G	AKM2G3-4	Типоразмер 15
C / G	AKM2G5-7 ≤ 20 A	Типоразмер 21
H	AKM2G7 > 20 A	Типоразмер 21

Коммутирующий энкодер

Тип разъема	Совместимый AKM2Gx	Тип
C / G	AKM2G3-4	Типоразмер 15

6.4 Техническое описание

6.4.1 Общие технические характеристики

Температура окружающей среды (при номинальных величинах)	5...+40°C для высоты до 1000 м над средним уровнем моря При температурах окружающей среды выше 40°C следует обратиться в наш отдел практического применения и использовать закрытую установку электродвигателей.
Допустимая влажность (при номинальных величинах)	относит. влажность 95 % без конденсации
Снижение мощности (токи и моменты)	1%/K в диапазоне 40°C...50°C до 1000 м над средним уровнем моря для высот более 1000 м над средним уровнем моря и 40°C 6% до 2000 м над средним уровнем моря 17% до 3000 м над средним уровнем моря 30% до 4000 м над средним уровнем моря 55% до 5000 м над средним уровнем моря Без снижения характеристик на высотах более 1000 м над средним уровнем моря при понижении температуры 10K / 1000 м
Срок службы шарикоподшипников	≥ 20000 отработанных часов

NOTE

Технические данные для каждого типа электродвигателя приведены в главе «Технические данные» [Technical Data](#).

6.4.2 Стандартные функции

6.4.2.1 Дизайн

Базовое исполнение АКМ2G электродвигателей – IM B5 в соответствии с EN 60034-7.

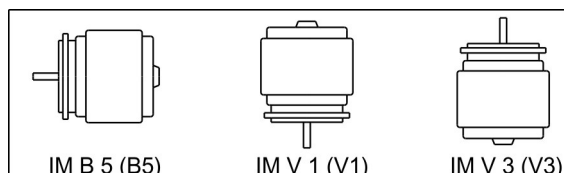

6.4.2.2 Фланец

Точность фланца IEC согласно DIN 42955. Допуски на биение вала и монтажные фланцы для вращающихся электрических машин.

Код	Фланец
A	IEC с точностью N, посадка АКМ2G2-7: j6

6.4.2.3 Класс защиты

По EN 60529.

Электродвигатель Standard	Вариант разъема	Сальник	Класс защиты
AKM2G2-AKM2G7	C, D, G, H, J, Y	без	IP54
AKM2G2-AKM2G7	C, D, G, H, J, Y	с	IP65

6.4.2.4 Класс теплоизолирующего материала

Электродвигатели поставляются с изоляцией класса нагревостойкости F согласно IEC 60085 (UL1446 класс F).

6.4.2.5 Поверхность

Электродвигатель покрыты эпоксидной смолой матово-черным порошковым покрытием. Чистовое покрытие не отличается стойкостью к растворителям (например, трихлорэтилену, разбавителям нитрокрасок и т.п.).

6.4.2.6 Конец вала, сторона А

Передача усилия осуществляется через цилиндрический конец вала А, посадка k6 согласно EN 50347, с герметиком для резьбы, но **без заполненного шпоночного паз**.

Электродвигатели также поставляются со шпоночным пазом и вставленной шпонкой согласно DIN 6885. Вал со шпоночным пазом отбалансирован с короткой (половинной) шпонкой.

Расчетный срок службы подшипников составляет 20000 отработанных часов.

Код заказа	Конец вала	Доступно для
N	Гладкий вал	AKM2G 2-7
C	Шпоночный паз, закрытый	AKM2G 2-7

Радиальное усилие

Если электродвигатели приводятся через шестерни или зубчатые ремни, будут иметь место высокие радиальные усилия. Допустимые величины на конце вала можно найти на диаграммах в главе «Чертежи» [Dimension drawings](#). Максимальные величины при номинальной частоте вращения приведены в технических данных [Technical Data](#). Отбор мощности с середины свободного конца вала позволяет на 10 % увеличить F_R .

Осевое усилие

Монтаж шестерней или колес на ось и использование, например, угловых зубчатых редукторов повышает осевые усилия. Максимальные величины при номинальной частоте вращения приведены в технических данных.

Муфта

Двухрядные патроны зарекомендовали себя как идеальные зажимные устройства, не имеющие люфта и при необходимости дополняющиеся металлическими сильфонными муфтами. Центровое отверстие вала согласно DIN 332, форма D.

6.4.2.7 Сальник

Если AKM2G подсоединен к фланцу машины с неуплотненным участком вала, то сальник (опция «Т» или «V») гарантирует уплотнение вала

- Уплотнение «Т» представляет собой PTFE-уплотнение с минеральным наполнителем (Teflon®), обладающее свойствами самосмазывания и рекомендуемое для областей применения, в которых регулярное смазывание уплотнения вала невозможно.
- Уплотнение «V» изготовлено из Viton® и рекомендуется для областей применения, допускающих регулярное смазывание уплотнения вала, например смазываемых редукторов.
- Сальник обеспечивает IP65 защиту области вала.
- Номинальные рабочие характеристики достигаются по истечении нескольких часов приработки сальника. Необходимости в специальной процедуре приработки нет.
- Определенное «осыпание» материала сальника, в частности, тефлона®, является нормальным явлением и не влияет на функциональность.
- Сальник предварительно смазан консистентной смазкой.

6.4.2.8 Защитное устройство

Каждый двигатель переменного тока в стандартном исполнении оснащается электрически изолированным PT-1000+ PTC. Каждый электродвигатель в низковольтном исполнении оснащается электрически изолированным PT-1000. Тепловые датчики не обеспечивают защиту от кратковременных сильных перегрузок.

Электродвигатель может поставляться с PT-1000 +PTC, PT-1000, PTC или в качестве опции с аналогами датчика KTY 84-130 (см. [Варианты теплового устройства: графики зависимости сопротивления от температуры 0, 1, 2 и 3](#)).

Цифровые системы обратной связи SFD3 (CA), Hiperface DSL (GU) и EnDat 2.2 (LD) передают статус датчика температуры в привод в цифровом формате и анализируют его.

При условии использования наших сконфигурированных кабелей обратной связи датчик встраивается в систему мониторинга цифровых сервоусилителей.

6.4.2.9.1 Варианты теплового устройства: графики зависимости сопротивления от температуры

Кривые дополнительного термооборудования показывают эквивалентное сопротивление в омах, соответствующее заданной температуре обмоток двигателя. Привод, используемый с двигателем, должен поддерживать надлежащий режим работы выбранного термооборудования.

Вариант термодатчика 0

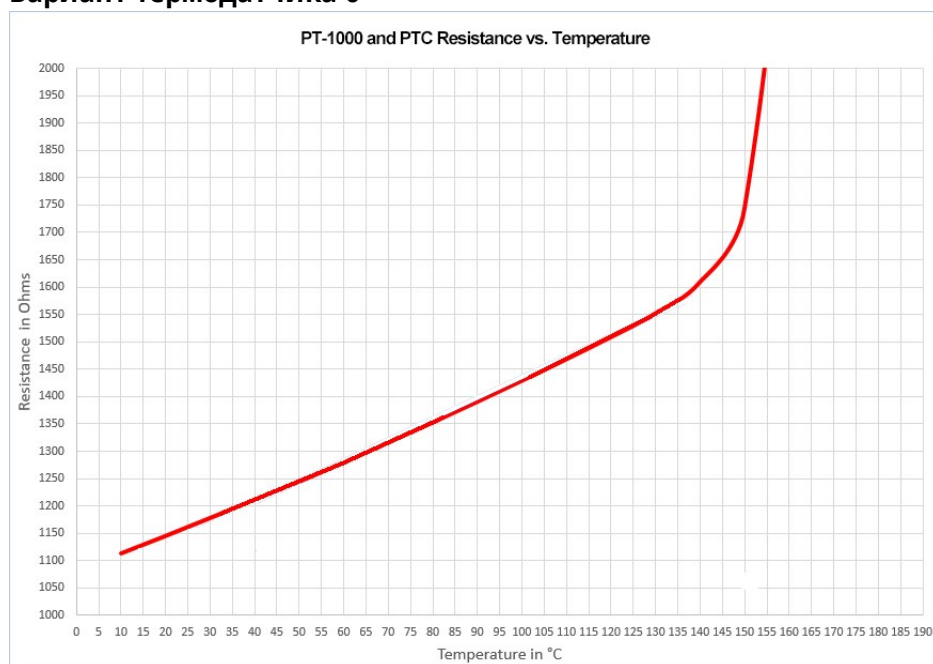

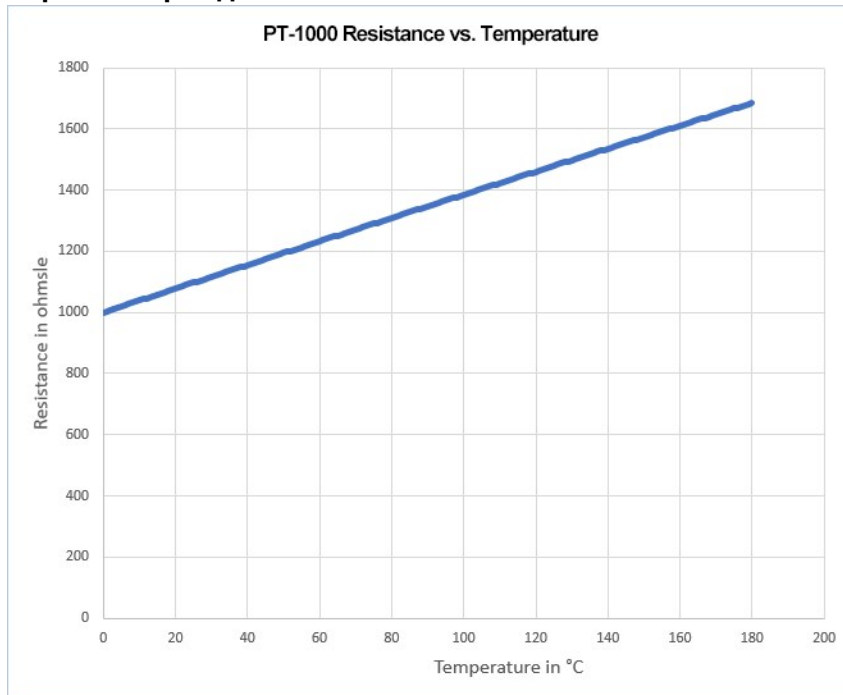
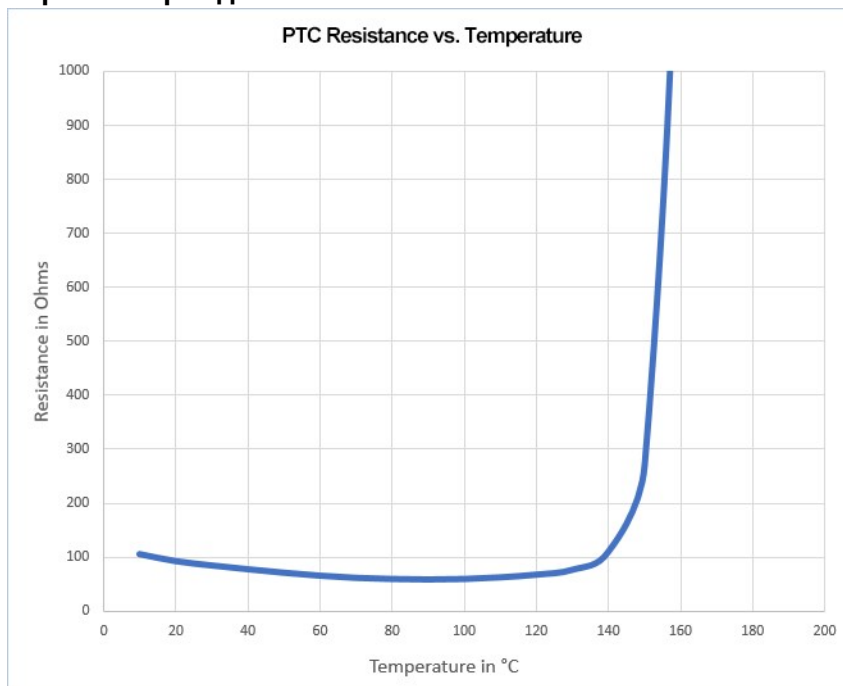
Вариант термодатчика 1**Вариант термодатчика 2**

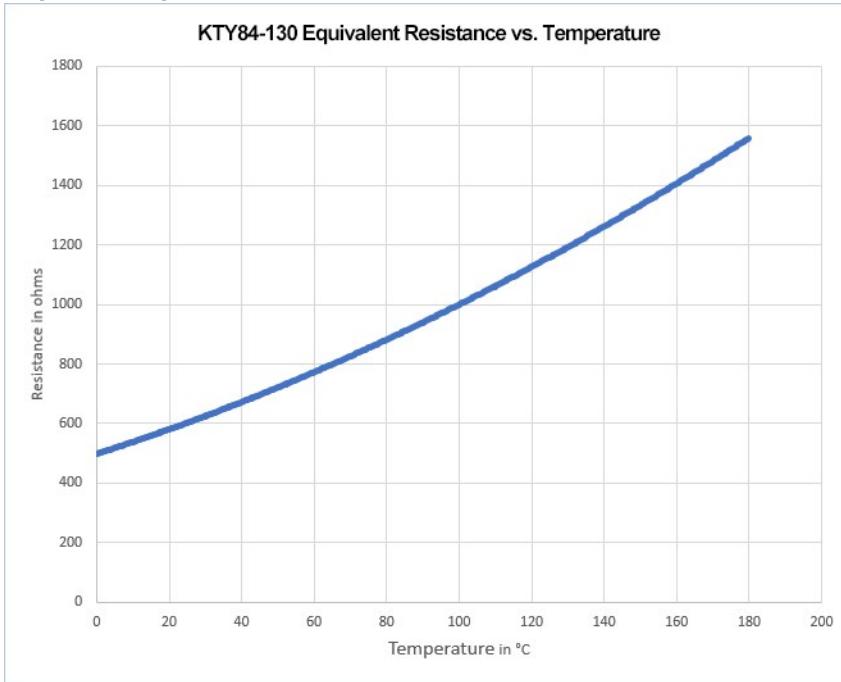
Вариант термодатчика 3**6.4.2.10 Уровень вибрации**

Двигатели соответствуют уровню вибрации А согласно DIN EN 60034-14. Это означает, что при частоте вращения в диапазоне 600-3600 об/мин и высоте оси между 56 и 132 мм допустимое эффективное значение скорости колебаний составляет 1,6 мм/с.

Частота вращения [об/мин]	макс. относительное виброперемещение [мкм]	макс. биение [мкм]
≤ 1800	90	23
> 1800	65	16

6.4.3 Технология монтажа

6.4.3.1 Подключение

Описание доступных разъемов: [Варианты разъемов \(C\)](#). Разводка выводов разъемов: : [Connector Pinout](#).

6.4.3.2 Сечение проводов

(Сечение проводов для температуры окружающей среды 40С)

Силовой кабель, комбинированный кабель

Комбинированные кабели содержат 4 силовых провода и 2 дополнительных провода для блока управления удерживающим тормозом электродвигателя.

Сечение		Токопроводящий Емкость	Примечания
Кабель	Комбинированный кабель		
(4x1)	(4x1+(2x0,75))	$0A < I_{0rms} \leq 10.1A$	Скобки (...) указывают на экранирование. Предельно допустимый ток согласно EN60204-1:2006 Таблица 6, столбец B2
(4x1,5)	(4x1,5+(2x0,75))	$10.1A < I_{0rms} \leq 13.1A$	
(4x2,5)	(4x2,5+(2x1))	$13.1A < I_{0rms} \leq 17.4A$	
(4x4)	(4x4+(2x1))	$17.4A < I_{0rms} \leq 23A$	
(4x6)	(4x6+(2x1))	$23A < I_{0rms} \leq 30A$	
(4x10)	(4x10+(2x1,5))	$30A < I_{0rms} \leq 40A$	
(4x16)	(4x16+(2x1,5))	$40A < I_{0rms} \leq 54A$	
(4x25)	(4x25+(2x1,5))	$54A < I_{0rms} \leq 70A$	

Кабель обратной связи

Тип	Сечение	Примечания
Резольвер	(4x2x0,25)	
с дополнительного	(4x2x0,25)	

Гибридный кабель

Тип	Сечение	Примечания
SFD3/DSL	(4x1,0+(2x0,34)+(2x0,75))	4 силовых провода и 2 провода управления тормозом и 2 сигнальных провода для SFD3/DSL 6 сигнальных проводов для EnDAT 2.2
SFD3/DSL	(4x1,5+(2x0,34)+(2x0,75))	
SFD3/DSL	(4x2,5+(2x0,34)+(2x1,0))	
SFD3/DSL	(4x4,0+(2x0,34)+(2x1,0))	
SFD3/DSL	(4x6,0+(2x0,34)+(2x1,0))	
EnDAT 2.2	(4x1,5 + (2x0,75) + (2x (2x0,14) + (2x0,25)))	
EnDAT 2.2	(4x4,0 + (2x1,0) + (2x (2x0,14) + (2x0,25)))	

6.4.4 Удерживающий тормоз

Все электродвигатели могут комплектоваться удерживающим тормозом. Подпружиненный тормоз (24 В=) встроен в электродвигатели. Если этот тормоз будет обесточен, он заблокирует ротор.



ОСТОРОЖНО

Если имеется подвешенный груз (вертикальные оси), тормоз электродвигателя отпущен и, в то же время, сервопривод не выдает мощности, груз может упасть! Опасность травмирования персонала, эксплуатирующего машину. Пользователь должен учитывать действующие местные стандарты безопасности при работе с висящими грузами (вертикальные оси) и необходимость обеспечения безопасности персонала, предпринимая дополнительные меры предотвращения рисков.

NOTICE

Тормоза выполнены в виде стояночных тормозов и не рассчитаны на многократное торможение во время эксплуатации. Частое торможение во время работы может привести к преждевременному износу и отказу удерживающего тормоза.

Длина электродвигателя увеличивается при установке удерживающего тормоза.

Удерживающий тормоз может управляться непосредственно сервоусилителем (безопасность персонала не гарантируется!), обмотка впрессована в сервоусилитель — дополнительный контур не требуется (см. руководство по эксплуатации сервоусилителя). Если сервопривод не управляет удерживающим тормозом непосредственно, необходим монтаж дополнительного элемента (например, варистора). Обратитесь в нашу службу поддержки.

Параметры тормоза указаны в главе «Технические данные тормоза» [Technical Data Brakes](#).

6.5 Механический монтаж

NOTE Габаритные чертежи приведены в главе «[Dimension drawings](#)».

6.5.1 Важные замечания

NOTE К сборке электродвигателей допускается только квалифицированный персонал, владеющий машиностроительными знаниями.

- Защитите электродвигатель от недопустимых нагрузок. Во время транспортировки и манипулирования ни один из компонентов не должен быть поврежден.
- На месте установки не должно быть проводящих или агрессивных материалов. Для установки V3 (конец вала вверх) следует убедиться в невозможности попадания жидкостей в подшипники.
- Убедитесь в беспрепятственной вентиляции электродвигателей и соблюдайте допустимые температуры окружающей среды и фланца. Для температур окружающей среды выше 40°C заблаговременно обратитесь в наш отдел практического применения. Проверьте достаточность теплопередачи в окружающую среду и на фланец электродвигателя.
- Фланец электродвигателя и вал чувствительны к хранению и сборке - избегайте приложения силы. Важно использовать герметик для резьбы при затяжке муфт, шестерней или шкивов, и прогревать компоненты привода (по возможности). Удары или приложение силы приведет к повреждению подшипников и вала.

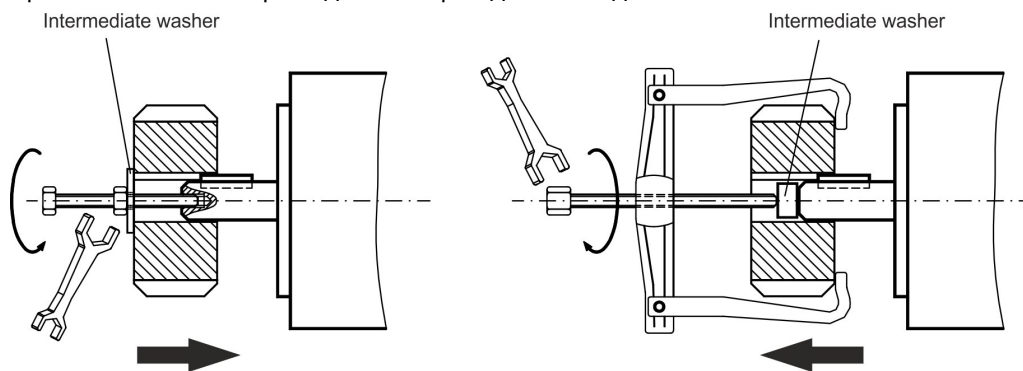

- По возможности, используйте только безлюфтовые патроны или муфты с фрикционным замыканием. Проверьте правильное выравнивание муфт. Смещение приведет к недопустимой вибрации и разрушению подшипников и муфты.
- В любом случае не следует использовать крепление вала двигателя с механическими ограничениями в виде жесткой муфты с дополнительными внешними подшипниками (например, в редукторе).
- Учитывайте количество полюсов электродвигателя и количество полюсов резольвера (при наличии) и проверьте правильность настроек в используемом сервоусилителе. Неправильная настройка может привести к разрушению электродвигателя, особенно малого электродвигателя.
- По возможности избегайте осевых нагрузок на вал двигателя. Осевая нагрузка значительно сокращает срок службы электродвигателя.
- Проверьте соответствие допустимым радиальным и осевым нагрузкам F_R и F_A . При использовании зубчато-ременной передачи минимально допустимый диаметр шестерни определяется, например, уравнением: $d_{\min} \geq (M_0/F_R)*2$

6.6 Электрический монтаж

NOTE

Разводка выводов для разъемов указана в главе «Разводка выводов разъемов» [Connector Pinout](#). Разводка со стороны сервоусилителя описана в руководстве по эксплуатации сервоусилителя.

6.6.1 Важные замечания

NOTE

К выполнению кабельной разводки электродвигателя допускаются только квалифицированные и опытные электрики.



ОПАСНО

При сборке и кабельной разводке обязательно проверьте, обесточены ли электродвигатели, так как напряжение может быть включено для любого подключаемого оборудования.



Прикосновение к оголенным контактам чревато тяжелыми травмами, в том числе со смертельным исходом. Убедитесь, что распределительный шкаф выключен (барьер, предупредительные знаки и т.п.). Напряжение можно подавать на отдельные участки во время настройки.

Запрещается разъединять электрические разъемы на электродвигателе, находящемся под напряжением. Опасность поражения электрическим током! В неблагоприятных обстоятельствах электрическая дуга может причинить вред людям и повредить контакты.

Опасное напряжение, обусловленное остаточным зарядом, может сохраняться на конденсаторах до 10 минут после отключения от электрической сети. Напряжение в управляющих и силовых проводах может сохраняться даже тогда, когда двигатель не вращается.

Измерьте напряжение промежуточного звена и дождитесь его снижения ниже 60 В.

NOTE

Символ соединения с корпусом  на электрических схемах означает, что необходимо установить электрическое соединение с максимально большой площадью контакта между указанным устройством и монтажной панелью в распределительном шкафу. Такое соединение предназначено для подавления ВЧ-помех; не следует путать его с символом PE (защитное заземление)  (мера защиты согласно EN 60204).

Для выполнения кабельной разводки электродвигателя воспользуйтесь электрическими схемами в Руководстве по установке и пусконаладке используемого сервоусилителя.

6.6.2 Руководство по электрическому монтажу

- Убедитесь в совместимости сервоусилителя и электродвигателя. Сравните номинальное напряжение и номинальный ток устройства. Выполните электрический монтаж по электрической схеме в руководстве по эксплуатации сервоусилителя. Подключения к электродвигателю показаны в главе «Разводка выводов разъемов» [Connector Pinout](#).
- Все кабели больших токов должны иметь достаточное сечение, соответствующее EN 60204. Рекомендуемые значения сечения см. технические данные.

NOTE

В случае длинных кабелей двигателя (>25 м) и в зависимости от типа используемого сервоусилителя потребуются включить в кабель двигателя дроссель электродвигателя (см. руководство по эксплуатации сервоусилителя и дополнительного оборудования).

- Обеспечьте надлежащее заземление сервоусилителя и электродвигателя. Используйте заземление и ЭМС-экранирование, соответствующие руководству по эксплуатации используемого сервоусилителя. Заземлите монтажную плату и корпус электродвигателя.
- Если используется кабель питания двигателя со встроенными проводами блока управления тормозом, необходимо экранировать эти провода блока управления тормозом. Экран следует подсоединять к обоим концам (см. руководство по эксплуатации сервоусилителя).
- Кабельная проводка:
 - По возможности, проложите силовые кабели отдельно от кабелей системы управления
 - Подсоедините устройство обратной связи.
 - Подсоедините кабели двигателя, установите дроссели электродвигателя (при наличии) вплотную к усилителю
 - Подсоедините экраны к клеммам экранирования или ЭМС-разъемам на обоих концах
 - Подсоедините удерживающий тормоз, при наличии
 - Подсоедините экран к обоим концам.
- При подсоединении всех экранов используйте контакт большой площади (низкий импеданс) и покрытые металлом корпуса разъемов или кабельные вводы ЭМС.
- Требования к материалу кабеля:

Емкость

Кабель двигателя: менее 150 пФ/м

Кабель обратной связи: менее 120 пФ/м

6.6.3 Подсоединение электродвигателей с предварительно собранными кабелями

- Выполните электрический монтаж в соответствии с действующими стандартами и нормативами.
- Используйте только Kollmorgen предварительно собранные экранированные кабели для подключения датчика и питания.
- Неправильное экранирование приведет к ЭМС-помехам и отрицательно отразится на функционировании системы.
- Максимальная длина кабеля определена в руководстве по эксплуатации используемого сервоусилителя.

NOTE

Детальное описание сконфигурированных кабелей см. руководство по региональному дополнительному оборудованию.

6.7 Настройка

6.7.1 Важные замечания

NOTE

К тестированию и настройке привода в составе сервоусилителя и электродвигателя допускаются только специалисты, имеющие навыки работы с электрооборудованием и приводами.



ОПАСНОСТЬ

Вероятно наличие смертельно опасного напряжения, до 900 В. Опасность поражения электрическим током! Убедитесь, что все токоведущие части надежно защищены от случайного контакта.

Запрещается разъединять электрические разъемы на электродвигателе, находящемся под напряжением. Опасность поражения электрическим током! Остаточный заряд в конденсаторах привода может поддерживать высокое напряжение до 10 минут после отключения от электрической сети.

Напряжение в управляющих и силовых проводах может сохраняться даже тогда, когда двигатель не вращается. Измерьте напряжение промежуточного звена и дождитесь его снижения ниже 60 В.



ВНИМАНИЕ

Температура поверхности электродвигателя во время работы может превышать 100°C. Опасность ожогов легкой степени! Проверьте (измерьте) температуру электродвигателя. Дождитесь охлаждения электродвигателя до температуры ниже 40°C перед тем, как прикоснуться к нему.



ВНИМАНИЕ

Невозможно предотвратить неожиданные движения привода во время ввода в эксплуатацию.

Убедитесь, что даже неожиданные движения привода не нанесут вреда персоналу или оборудованию.

Необходимые меры в этом случае определяются анализом рисков для конкретной области применения.

6.7.2 Руководство по пусконаладке

Процедура пусконаладки дана для примера. Могут оказаться подходящими или необходимыми другие методы, в зависимости от области применения оборудования.

1. Проверьте монтаж и ориентацию электродвигателя.
2. Проверьте компоненты привода (муфту, редуктор, шкив ремня) на предмет правильной посадки и настройки (соблюдайте допустимые радиальные и осевые усилия).
3. Проверьте монтаж и разъемы электродвигателя и сервоусилителя. Проверьте правильность выполнения заземления.
4. Проверьте работоспособность удерживающего тормоза, при наличии. (при приложении 24 В тормоз должен быть отпущен).
5. Проверьте, свободно ли вращается ротор электродвигателя (отпустите тормоз при необходимости). Прислушайтесь, не раздаются ли скрежещущие звуки.
6. Убедитесь, что приняты все необходимые меры по предотвращению случайного контакта с токоведущими и движущимися частями.
7. Выполните все дополнительные проверки, специфичные для вашей системы.
8. Перейдите к вводу привода в эксплуатацию в соответствии с инструкциями по пусконаладке сервоусилителя.
9. В многокоординатных системах потребуется отдельный ввод в эксплуатацию каждого компонента привода (усилителя и электродвигателя).

6.7.3 Устранение неисправностей

Следующую таблицу следует рассматривать как средство «первой помощи». Возможно существование множества различных причин отказа в зависимости от конкретных условий вашей системы. Причины отказов, описанные ниже, наиболее часто непосредственно влияют на электродвигатель. Особенности поведения контура управления обычно удается проследить до ошибки в параметрах сервоусилителя. Документация к сервоусилителю и наладочному ПО содержит информацию по этим вопросам.

В многокоординатных системах могут иметься дополнительные скрытые причины отказов.

Отказ	Возможная причина	Меры по устранению причины отказа
Электродвигатель не вращается	<ul style="list-style-type: none"> — Сервоусилитель не включен — Обрыв провода передачи уставки — Неправильная последовательность фаз электродвигателя — Тормоз не отпущен — Привод механически заблокирован 	<ul style="list-style-type: none"> — Разрешающий сигнал питания — Проверьте провод передачи уставки — Исправьте фазировку — Проверьте блок управления тормозом — Проверьте механизм
Электродвигатель идет вразнос	<ul style="list-style-type: none"> — Неправильная последовательность фаз электродвигателя 	<ul style="list-style-type: none"> — Исправьте фазировку
Электродвигатель вибрирует	<ul style="list-style-type: none"> — Обрыв экранирования кабеля резольвера — Коэффициент усиления усилителя слишком высок 	<ul style="list-style-type: none"> — Замените кабель обратной связи — Используйте стандартные значения электродвигателя
Сигнал о неисправности: тормоз	<ul style="list-style-type: none"> — Короткое замыкание в силовом кабеле к удерживающему тормозу электродвигателя — Неисправность удерживающего тормоза электродвигателя 	<ul style="list-style-type: none"> — Устраните короткое замыкание — Замените электродвигатель
Сигнал о неисправности: ошибка выходного каскада	<ul style="list-style-type: none"> — Короткое замыкание или замыкание на массу кабеля двигателя — Короткое замыкание или замыкание на массу электродвигателя 	<ul style="list-style-type: none"> — Замените кабель — Замените электродвигатель
Сигнал о неисправности: обратная связь	<ul style="list-style-type: none"> — Разъем обратной связи неправильно подключен — Разрыв кабеля обратной связи, кабель разорван или имеет иные повреждения 	<ul style="list-style-type: none"> — Проверьте разъем — Проверьте кабели

Отказ	Возможная причина	Меры по устранению причины отказа
Сигнал о неисправности: температура электродвигателя	<ul style="list-style-type: none"> — Термодатчик электродвигателя переключен — Ослабление разъема обратной связи или обрыв кабеля обратной связи 	<ul style="list-style-type: none"> — Дождитесь охлаждения электродвигателя. После этого выясните, почему электродвигатель настолько нагревается. — Проверьте разъем, замените кабель обратной связи при необходимости
Тормоз не держит	<ul style="list-style-type: none"> — Необходимый тормозной момент слишком велик — Отказ тормоза — Осевая перегрузка вала двигателя 	<ul style="list-style-type: none"> — Проверьте размеры — Замените электродвигатель — Проверьте осевую нагрузку, уменьшите ее. Замените электродвигатель, если повреждены подшипники

6.8 Термины и определения для технических данных

NOTE

Технические данные для каждого типа электродвигателя приведены в главе «Технические данные» [Technical Data](#).

Все параметры даны для температуры окружающей среды 40°C и перегрева обмотки 100K. Определение номинальных данных с постоянной температурой фланца переходника 65°C. Данные могут иметь допуск +/- 10%.

Пусковой момент M_0 [Nm]

Момент покоя можно поддерживать неограниченное время при частоте вращения $0 \leq n \leq 100$ об/мин и номинальных условиях окружающей среды.

Номинальный момент M_n [Nm]

Номинальный момент имеет место, когда электродвигатель работает с номинальным током при номинальной частоте вращения. Номинальный момент может генерироваться бесконечно при номинальной частоте вращения в продолжительном режиме (S1).

Ток удержания I_{0rms} [A]

Ток покоя представляет собой действующий синусоидальный ток, генерируемый электродвигателем при $0 \leq n \leq 100$ об/мин для выработки момента покоя.

Пиковый ток (импульсный ток) I_{0max} [A]

Пиковый ток (действующее синусоидальное значение) в несколько раз превышает номинальный ток в зависимости от обмотки двигателя. Текущее значение определяется по пиковому току используемого привода.

Постоянная момента K_{Trms} [Нм/А]

Постоянная момента определяет, какой момент в Нм будет производиться электродвигателем при действующем токе 1А. Действительно соотношение: $M = I \times K_T$.

Постоянная напряжения K_{Erms} [мВ/мин-1]

Постоянная напряжения определяет индуцированную ЭДС электродвигателя как действующее синусоидальное значение между двумя клеммами, на 1000 об/мин. Измерено при 25°C.

Момент инерции ротора J [кгсм²]

Постоянная J – способ разгона электродвигателя. Например, при I_0 время разгона t_b с 0 до 3000 об/мин равно:

$$T_b [s] = \frac{2500 \cdot 2\pi}{M_0 \cdot 60s} \cdot \frac{m^2}{10^4 \cdot cm^2} \cdot J \quad \text{где } M_0 \text{ в Нм, а } J \text{ в кгсм}^2$$

Тепловая постоянная времени t_{th} [мин]

Постоянная t_{th} определяет время нахождения холодного электродвигателя под нагрузкой I_0 для прогрева до уровня перегрева $0,63 \times 105$ К. Это повышение температуры значительно ускоряется, если электродвигатель нагружен пиковым током.

Задержка отпущения t_{BRH} [мс] / задержка включения t_{BRL} [мс] тормоза

Эти постоянные определяют время реакции удерживающего тормоза при работе с номинальным напряжением от сервоусилителя.

U_N

Номинальное напряжение сети

U_n

Напряжение промежуточного звена постоянного тока. $U_n = \sqrt{2} \cdot U_N$

7 Technical Data

All data valid for 40°C environmental temperature and 100K overtemperature of the winding.
Determination of nominal data with constant temperature of adapter flange of 65°C. The data can have a tolerance of +/- 10%.

7.1 Dictionary for technical data tables

7.1.1 Motor

English	Deutsch	Italiano	Español	Français	Русский
Data	Daten	Dati	Datos	Caractéristiques	Данные
Symbol [Unit]	Symbol [Einheit]	Simbolo [unità]	Símbolo [unidad]	Symbole [unité]	Символ [узел]
Electrical data	Elektrische Daten	Dati elettrici	Datos eléctricos	Caractéristiques électriques	Электрические характеристики
Standstill torque	Stillstands Drehmoment	Coppia cont. allo stallo	Par motor de parada	Couple d'arrêt	Момент покоя
Standstill current	Stillstandsstrom	Corrente cont. allo stallo	Corriente de parada	Courant d'arrêt	Ток покоя
max. Mains voltage	max. Netz-Nennspannung	Tensione di rete nom. max.	Tensión max del red	Tension secteur max.	макс. Напряжение сети
Rated speed	Nenn Drehzahl	Velocità nominale	Velocidad nominal	Vitesse nominale	Номинальная скорость
Rated torque	Nenn Drehmoment	Coppia nominale	Par motor nominal	Couple nominal	Номинальный момент
Rated power	Nennleistung	Potenza nominale	Potencia nominal	Puissance nominale	Номинальная мощность
Peak current	Spitzenstrom	Corrente di picco	Corriente máxima	Courant de crête	Пиковый ток
Peak torque	Spitzendrehmoment	Coppia di picco	Par motor motor máximo	Couple de crête	Пиковый момент
Torque constant	Drehmomentkonstante	Costante di coppia	Constante de par motor	Constante de couple	Постоянная момента
Voltage constant	Spannungskonstante	Costante di tensione	Constante de tensión	Constante de tension	Постоянная напряжения
Winding resistance	Wicklungswiderstand	Resistenza avvolgimento	Resistencia de la bobina	Résistance de l'enroulement	Сопротивление обмотки
Winding inductance	Wicklungsinduktivität	Induttività avvolgimento	Inductividad de la bobina	Inductance de l'enroulement	Индуктивное сопротивление обмотки
Mechanical data	Mechanische Daten	Dati meccanici	Datos mecánicos	Caractéristiques mécaniques	Механические характеристики
Rotor moment of inertia	Rotorträgheitsmoment	Momento di inerzia del rotore	Momento de inercia del rotor	Moment d'inertie du rotor	Момент инерции ротора
Pole number	Polzahl	Numero di poli	N° de polos	Nombre de pôles	Количество полюсов
Static friction torque	Statisches Reibmoment	Momento di aderenza statica	Par estático de fricción	Couple de friction statique	Статический момент трения
Thermal time constant	Thermische Zeitkonstante	Costante di tempo termica	Constante térmica de tiempo	Constante de temps thermique	Тепловая постоянная времени

English	Deutsch	Italiano	Español	Français	Русский
Weight standard	Gewicht standard	Peso standard	Peso de estándar	Poids standard	Весовой стандарт
Radial load permitted at shaft end	Zulässige Radialkraft am Wellenende	Soll. radiale ammessa sull'estr. dell'albero	Fuerza radiale admitido en el extremo del eje	Charge radiale admissible en bout d'arbre	Допустимая радиальная нагрузка на конце вала
Axial load permitted	Zulässige Axialkraft	Soll. assiale ammessa	Fuerza axial admitido	Charge axiale admissible	Допустимая осевая нагрузка
Minimum cross section	Minimaler Querschnitt	Sezione max.	Sección máx.	Section minimale	Мин. сечение
Reference flange	Bemessungsflansch	Flangia di calcolo	Brida de la referencia	Bride de référence	Опорный фланец
Derating for feedback, brake, shaft seal	Begrenzung der Nennwerte bei eingebautem Encoder (und Bremse)	Riducendo le imposte nel caso del codificatore (e del freno) incorporati	El reducir la capacidad normal en caso de codificador (y de freno) incorporados	Réduction de puissance pour la rétroaction, le frein, le joint d'arbre	Снижение характеристик для обратной связи, тормозной системы, сальника

7.1.2 Brake

English	Deutsch	Italiano	Español	Français	Русский
Brake data	Bremsendaten	Dati freno	Datos de frenos	Caractéristiques du frein	Характеристики тормозной системы
Holding torque	Haltemoment	Coppia di arresto	Momento de parada	Couple de maintien	Удерживающий момент
Operating voltage	Anschlussspannung	Tensione di allacciamento	Tensión de conexión	Tension de service	Рабочее напряжение
Electrical power	Elektrische Leistung	Potenza elettrica	Potencia eléctrica	Puissance électrique	Электрическая мощность
Moment of inertia	Trägheitsmoment	Momento d'inerzia	Momento de inercia	Moment d'inertie	Момент инерции
Release delay time	Lüftverzögerungszeit	Ritardo al rilascio	Tiempo de respuesta	Délai d'attente de desserrage	Задержка отпущения
Engage delay time	Einfallverzögerungszeit	Ritardo all'incidenza	Tiempo de reacción	Délai d'attente de serrage	Задержка включения
Weight of the brake	Gewicht der Bremse	Peso del freno	Peso de freno	Poids du frein	Вес тормоза
Typical backlash	typisches Spiel	Gioco tipico	Contragolpe típico	Jeu typique	Стандартный люфт

7.2 Technical Data AKM2G-2x Series

7.2.1 Technical Data AKM2G-21

UN	Parameter	Tolerance	Symbol	Units	AKM2G		
					21D	21E	21G
Electrical data							
	Max. Rated Equivalent Line Voltage	Max	V bus	V ac	480	240	120
	Max. Continuous Torque for ΔT winding = 100°C (1)(2)(4)	Nom	Tmc	Nm	0.636	0.642	0.649
				lb-in	5.62	5.68	5.75
	Max. Continuous Current for ΔT winding = 100°C (1)(2)(4)	Nom	Imc	Arms	2.17	2.73	4.18
	Max. Continuous Torque for ΔT winding = 60°C (2)(4)	Nom	Tmc	Nm	0.494	0.498	0.503
				lb-in	4.37	4.41	4.45
	Max. mechanical speed (5)	Nom	Nmax	rpm	8000	8000	8000
	Peak Torque (1)(2)(4)	Nom	Tp	Nm	1.78	1.79	1.79
				lb-in	15.7	15.8	15.9
	Peak Current	Nom	Ip	Arms	8.66	10.9	16.7
120 V AC	Rated Torque (speed) (1)(2)(4)		Trtd	Nm	0.583	0.568	0.545
				lb-in	5.16	5.02	4.82
	Rated Speed		Nrtd	rpm	4800	6200	8000
	Rated Power (speed) (1)(2)(4)		Prtd	kW	0.293	0.369	0.456
				Hp	0.393	0.494	0.612
240 V AC	Rated Torque (speed) (1)(2)(4)		Trtd	Nm	0.534	0.534	
				lb-in	4.73	4.73	
	Rated Speed		Nrtd	rpm	8000	8000	
	Rated Power (speed) (1)(2)(4)		Prtd	kW	0.448	0.448	
				Hp	0.600	0.600	
400 V AC	Rated Torque (speed) (1)(2)(4)		Trtd	Nm	0.525		
				lb-in	4.64		
	Rated Speed		Nrtd	rpm	8000		
	Rated Power (speed) (1)(2)(4)		Prtd	kW	0.439		
				Hp	0.589		
480 V AC	Rated Torque (speed) (1)(2)(4)		Trtd	Nm	0.520		
				lb-in	4.60		
	Rated Speed		Nrtd	rpm	8000		
	Rated Power (speed) (1)(2)(4)		Prtd	kW	0.435		
				Hp	0.584		

UN	Parameter	Tolerance	Symbol	Units	AKM2G		
					21D	21E	21G
	Torque Constant (1)	+/- 10%	Kt	Nm/Arms	0.296	0.238	0.157
				lb-in/Arms	2.62	2.10	1.39
	Back EMF Constant (6)	+/- 10%	Ke	Vrms/krpm	19.5	15.6	10.3
	Motor Constant (1)	Nom	Km	Nm/√W	0.0895	0.0902	0.0911
				lb-in/√W	0.792	0.798	0.807
	Resistance (line-line) (6)	+/- 10%	Rm	Ω	7.30	4.63	1.97
	Inductance Q-Axis (line-line)		Lqll	mH	16.3	10.5	4.55
	Inductance D-Axis (line-line)		Ldll	mH	TBD	TBD	TBD
	Inductance Saturation Current		Lisat	Arms	15	19	29
	Maximum Demagnetization Current		Midpeak	Arms	TBD	TBD	TBD

Parameter	Symbol	Units	AKM2G		
			21D	21E	21G
Mechanical Data					
Inertia (incl. Resolver feedback) (3)	Jm	kgcm ²	0.093		
		lb-in-s ²	8.23E-05		
Optional Brake Inertia (additional)	Jm	kgcm ²	0.040		
		lb-in-s ²	3.54E-05		
Weight (8)	W	kg	1.1		
		lb	2.4		
Static Friction (1)	Tf	Nm	0.006		
		lb-in	0.05		
Viscous Damping (1)	Kdv	Nm/krpm	0.0015		
		lb-in/krpm	0.013		
Thermal Time Constant	TCT	mins.	9.6		
Thermal Resistance	Rthw-a	°C/W	1.33		
Pole Pairs	PP		3		
Heatsink Size			10" x 10" x 1/4" Aluminum Plate		

1. Motor winding at temp. rise, $\delta T = 100^{\circ}\text{C}$, at 40°C ambient
2. All data referenced to sinusoidal commutation
3. Add parking brake if applicable for total inertia
4. Motor with resolver feedback and standard heat sink
5. May be limited at some values of V_{bus}
6. Measured at 25°C
7. See de-rate chart for the de-rate of different motor options.
8. Brake motor adds 0.45 kg [1.0 lbs]
9. Shaft seal increases Static Friction by 0.020 Nm [0.21 lb-in]

Brake options are listed in chapter "Technical Data Brakes" from [Technical Data Brakes](#).

7.2.1.1 AKM2G-21 Derates for Different Options

Note: Derate information is for general estimation only. For the most accurate information for your motor use the online Performance Curve Generator located at pcgh.kollmorgen.com, the AKM2G Performance Curves document available for download at www.kollmorgen.com/sites/default/files/public_downloads/AKM2G%20Performance%20Curves_0.pdf, or refer to Kollmorgen's Motioneering Software Tool at www.kollmorgen.com/en-us/service-and-support/technical/motioneering-online/.

De-rates are referenced to the Max Continuous Torque ΔT wdg. = 100°C

Options - No Brake	Speed: RPM								
	0	1000	2000	3000	4000	5000	6000	7000	8000
Resolver	100.0%	98.2%	96.0%	93.7%	91.3%	89.0%	86.6%	84.2%	81.8%
Resolver/Seal	96.8%	95.0%	92.6%	90.2%	87.8%	85.4%	82.9%	80.4%	77.9%
SFD	100.0%	98.2%	96.0%	93.7%	91.3%	89.0%	86.6%	84.2%	81.8%
SFD/Seal	96.8%	95.0%	92.6%	90.2%	87.8%	85.4%	82.9%	80.4%	77.9%
DSL	100.0%	98.2%	96.0%	93.7%	91.3%	89.0%	86.6%	84.2%	81.8%
DSL/seal	96.8%	95.0%	92.6%	90.2%	87.8%	85.4%	82.9%	80.0%	76.8%
EnDat2.2	97.7%	95.8%	93.4%	90.9%	88.5%	86.0%	83.6%	81.1%	78.6%
EnDat2.2/Seal	94.4%	91.9%	88.7%	85.4%	82.1%	78.8%	75.5%	72.1%	68.7%

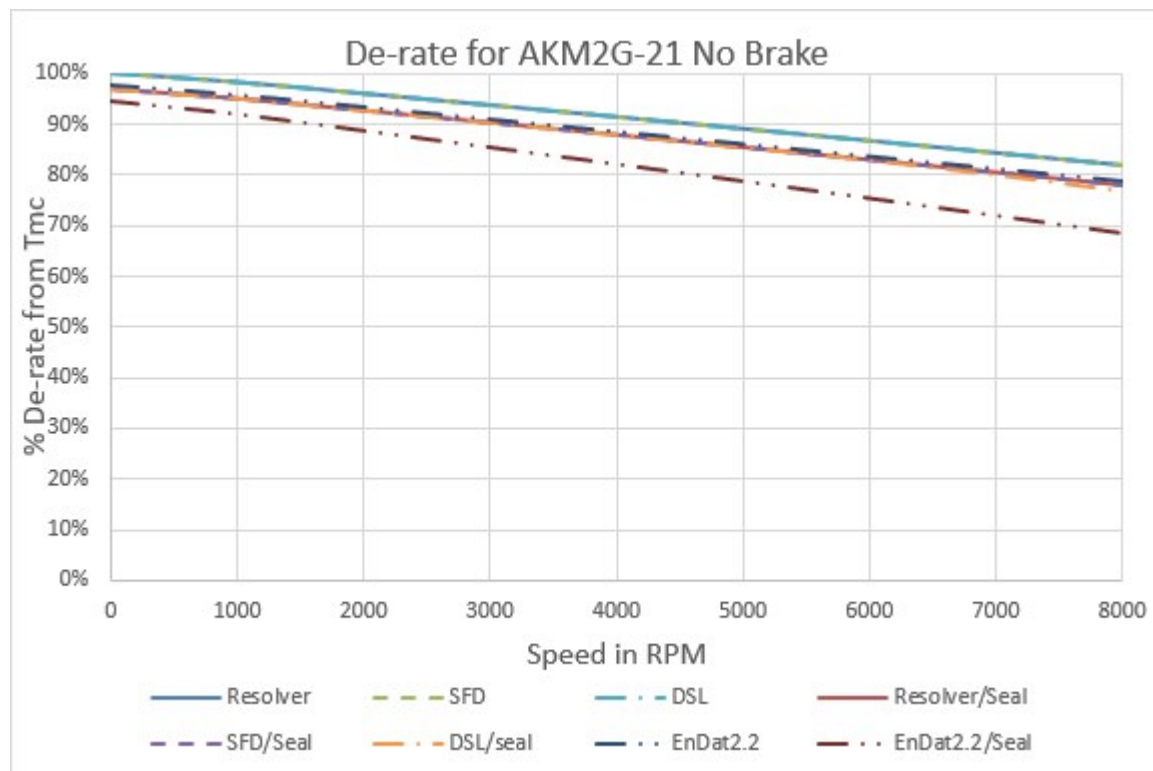

De-rates are referenced to the Max Continuous Torque ΔT wdg. = 100°C

Options - Brake	Speed: RPM								
	0	1000	2000	3000	4000	5000	6000	7000	8000
Resolver	98.2%	96.4%	94.2%	91.9%	89.5%	87.2%	84.8%	82.4%	80.0%
Resolver/Seal	95.0%	93.2%	90.8%	88.4%	86.0%	83.6%	81.1%	78.6%	76.1%
SFD	98.2%	96.4%	94.2%	91.9%	89.5%	87.2%	84.8%	82.4%	80.0%
SFD/Seal	95.0%	93.2%	90.8%	88.4%	86.0%	83.6%	81.1%	78.6%	76.1%
DSL	98.2%	96.4%	94.2%	91.9%	89.5%	87.2%	84.8%	82.4%	80.0%
DSL/seal	95.0%	93.2%	90.8%	88.4%	86.0%	83.6%	81.1%	78.6%	76.1%
EnDat2.2	97.1%	95.2%	92.8%	90.4%	87.9%	85.5%	83.0%	80.6%	78.1%
EnDat2.2/Seal	93.8%	91.3%	88.1%	84.8%	81.5%	78.2%	74.9%	71.5%	68.1%

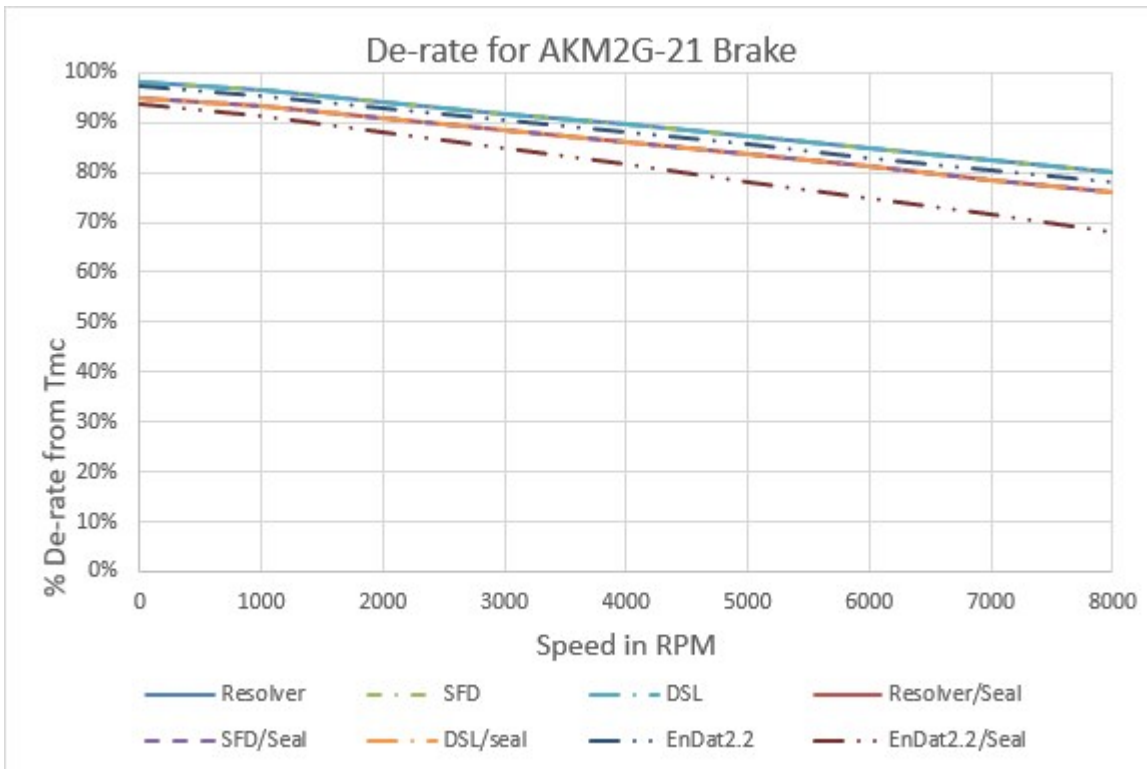

Note: For EnDat feedback motors acceleration of the motor is limited to $\leq 1 \cdot 10^5$ rad/s². The connected servo drive may further limit this value.

7.2.2 Technical Data AKM2G-21L

UN	Parameter	Tolerance	Symbol	Units	AKM2G		
					KL	ML	PL
Electrical data							
	Max. Rated DC Bus Voltage	Max	V bus	V dc	170	170	170
	Max. Continuous Torque for ΔT winding = 100°C (1)(2)(4)	Nom	Tmc	Nm	0.640	0.642	0.642
				ib-in	5.66	5.68	5.68
	Max. Continuous Current for ΔT winding = 100°C (1)(2)(4)	Nom	Imc	Arms	9.87	14.2	19.7
	Max. Continuous Torque for ΔT winding = 60°C (2)(4)	Nom	Tmc	Nm	0.497	0.498	0.498
				lb-in	4.39	4.41	4.41
	Max. mechanical speed (5)	Nom	Nmax	rpm	8000	8000	8000
	Peak Torque (1)(2)(4)	Nom	Tp	Nm	1.78	1.79	1.79
				lb-in	15.8	15.8	15.8
	Peak Current	Nom	Ip	Arms	39.5	56.8	78.6
24 V DC	Rated Torque (speed) (1)(2)(4)		Trtd	Nm		0.605	0.587
				lb-in		5.35	5.20
	Rated Speed		Nrtd	rpm		3400	4700
	Rated Power (speed) (1)(2)(4)		Prtd	kW		0.215	0.289
Hp					0.289	0.388	
48 V DC	Rated Torque (speed) (1)(2)(4)		Trtd	Nm	0.574	0.539	0.534
				lb-in	5.08	4.77	4.73
	Rated Speed		Nrtd	rpm	5600	8000	8000
	Rated Power (speed) (1)(2)(4)		Prtd	kW	0.337	0.452	0.45
Hp				0.451	0.606	0.600	
72 V DC	Rated Torque (speed) (1)(2)(4)		Trtd	Nm	0.537		
				lb-in	4.76		
	Rated Speed		Nrtd	rpm	8000		
	Rated Power (speed) (1)(2)(4)		Prtd	kW	0.450		
Hp				0.604			
96 V DC	Rated Torque (speed) (1)(2)(4)		Trtd	Nm	0.533		
				lb-in	4.71		
	Rated Speed		Nrtd	rpm	8000		
	Rated Power (speed) (1)(2)(4)		Prtd	kW	0.446		
Hp				0.598			

UN	Parameter	Tolerance	Symbol	Units	AKM2G		
					KL	ML	PL
	Torque Constant (1)	+/- 10%	Kt	Nm/Arms	0.0655	0.0457	0.0330
				lb-in/Arms	0.580	0.405	0.292
	Back EMF Constant (6)	+/- 10%	Ke	Vrms/krpm	4.31	3.01	2.17
	Motor Constant (1)	Nom	Km	Nm/√W	0.0899	0.0902	0.0902
				lb-in/√W	0.796	0.798	0.798
	Resistance (line-line) (6)	+/- 10%	Rm	Ω	0.354	0.171	0.089
	Inductance Q-Axis (line-line)		Lqll	mH	0.79	0.39	0.20
	Inductance D-Axis (line-line)		Ldll	mH	TBD	TBD	TBD
	Inductance Saturation Current		Lisat	Arms	69	99	137
	Maximum Demagnetization Current		Midpeak	Arms	TBD	TBD	TBD

Parameter	Symbol	Units	AKM2G		
			KL	ML	PL
Mechanical Data					
Inertia (incl. Resolver feedback) (3)	Jm	kgcm ²	0.093		
		lb-in-s ²	8.23E-05		
Optional Brake Inertia (additional)	Jm	kgcm ²	0.040		
		lb-in-s ²	3.54E-05		
Weight (8)	W	kg	1.1		
		lb	2.4		
Static Friction (1)	Tf	Nm	0.006		
		lb-in	0.05		
Viscous Damping (1)	Kdv	Nm/krpm	0.0015		
		lb-in/krpm	0.013		
Thermal Time Constant	TCT	mins.	9.6		
Thermal Resistance	Rthw-a	°C/W	1.33		
Pole Pairs	PP		3		
Heatsink Size			10" x 10" x 1/4" Aluminum Plate		

1. Motor winding at temp. rise, $\delta T = 100^{\circ}\text{C}$, at 40°C ambient
2. All data referenced to sinusoidal commutation
3. Add parking brake if applicable for total inertia
4. Motor with resolver feedback and standard heat sink
5. May be limited at some values of V_{bus}
6. Measured at 25°C
7. See de-rate chart for the de-rate of different motor options.
8. Brake motor adds 0.45 kg [1.0 lbs]
9. Shaft seal increases Static Friction by 0.020 Nm [0.21 lb-in]

Brake options are listed in chapter "Technical Data Brakes" from [Technical Data Brakes](#).

7.2.2.1 AKM2G-21L Derates for Different Options

Note: Derate information is for general estimation only. For the most accurate information for your motor use the online Performance Curve Generator located at pcgh.kollmorgen.com, the AKM2G Performance Curves document available for download at www.kollmorgen.com/sites/default/files/public_downloads/AKM2G%20Performance%20Curves_0.pdf, or refer to Kollmorgen's Motioneering Software Tool at www.kollmorgen.com/en-us/service-and-support/technical/motioneering-online/.

De-rates are referenced to the Max Continuous Torque ΔT wdg. = 100°C

Options - No Brake	Speed: RPM									
	0	1000	2000	3000	4000	5000	6000	7000	8000	
SFD	100.0%	100.0%	98.4%	96.3%	94.2%	92.1%	89.9%	87.7%	85.5%	83.2%
SFD/Seal	96.8%	96.9%	95.2%	93.0%	90.8%	88.6%	86.3%	84.0%	81.7%	79.4%
DSL	100.0%	100.0%	98.4%	96.3%	94.2%	92.1%	89.9%	87.7%	85.5%	83.2%
DSL/seal	96.8%	96.9%	95.2%	93.0%	90.8%	88.6%	86.3%	84.0%	81.5%	78.6%
EnDat2.2	97.7%	97.8%	96.0%	93.8%	91.6%	89.4%	87.2%	84.9%	82.7%	80.4%
EnDat2.2/Seal	94.4%	94.5%	92.1%	89.2%	86.2%	83.1%	80.1%	77.0%	73.9%	70.7%

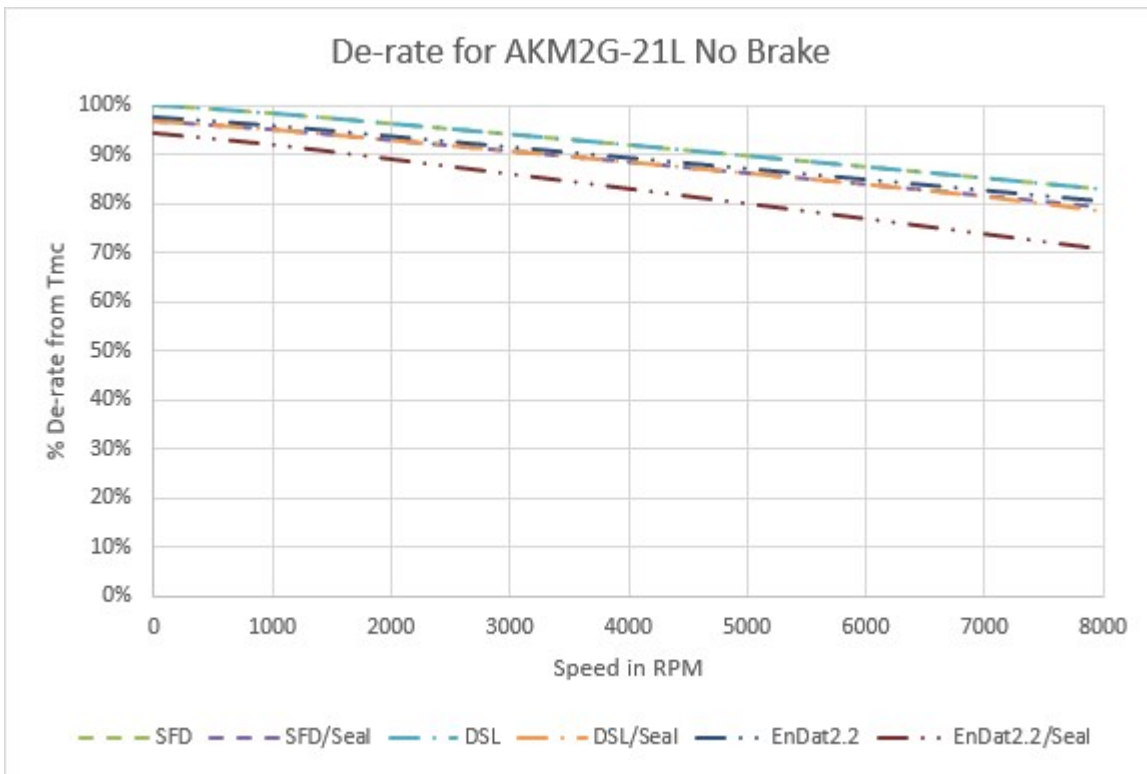

De-rates are referenced to the Max Continuous Torque ΔT wdg. = 100°C

Options - Brake	Speed: RPM								
	0	1000	2000	3000	4000	5000	6000	7000	8000
SFD	98.2%	96.6%	94.5%	92.4%	90.3%	88.1%	85.9%	83.7%	81.5%
SFD/Seal	95.0%	93.3%	91.2%	89.0%	86.8%	84.5%	82.3%	80.0%	77.6%
DSL	98.2%	96.6%	94.5%	92.4%	90.3%	88.1%	85.9%	83.7%	81.5%
DSL/seal	95.0%	93.3%	91.2%	89.0%	86.8%	84.5%	82.3%	80.0%	77.6%
EnDat2.2	97.2%	95.4%	93.2%	91.0%	88.8%	86.6%	84.4%	82.1%	79.9%
EnDat2.2/Seal	93.9%	91.5%	88.6%	85.6%	82.5%	79.5%	76.4%	73.3%	70.1%

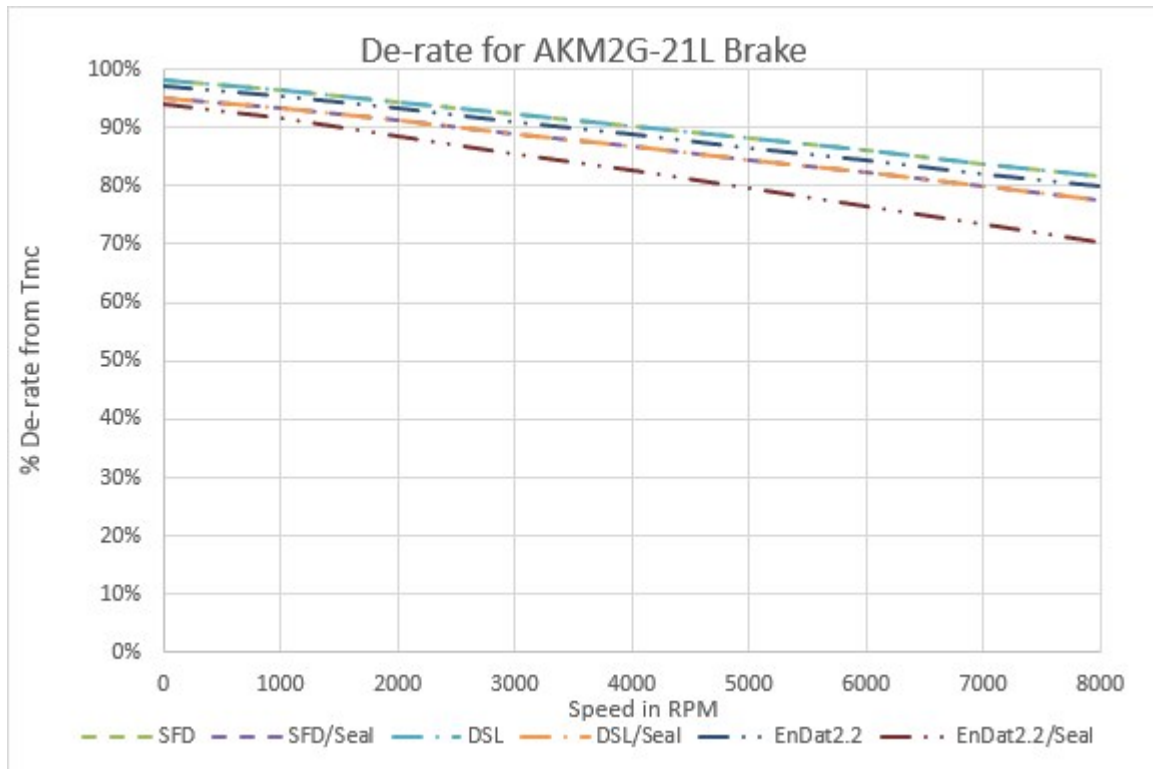

Note: For EnDat feedback motors acceleration of the motor is limited to $\leq 1 \cdot 10^5$ rad/s². The connected servo drive may further limit this value.

7.2.3 Technical Data AKM2G-22

UN	Parameter	Tolerance	Symbol	Units	AKM2G		
					22C	22D	22E
Electrical data							
	Max. Rated Equivalent Line Voltage	Max	V bus	V ac	480	480	240
	Max. Continuous Torque for ΔT winding = 100°C (1)(2)(4)	Nom	Tmc	Nm	1.11	1.11	1.11
				lb-in	9.80	9.81	9.86
	Max. Continuous Current for ΔT winding = 100°C (1)(2)(4)	Nom	Imc	Arms	1.65	2.37	2.93
	Max. Continuous Torque for ΔT winding = 60°C (2)(4)	Nom	Tmc	Nm	0.859	0.861	0.863
				lb-in	7.60	7.62	7.64
	Max. mechanical speed (5)	Nom	Nmax	rpm	8000	8000	8000
Peak Torque (1)(2)(4)	Nom	Tp	Nm	3.33	3.33	3.34	
			lb-in	29.4	29.5	29.5	
Peak Current	Nom	Ip	Arms	6.62	9.49	11.7	
120 V AC	Rated Torque (speed) (1)(2)(4)		Trtd	Nm	1.09	1.07	1.06
				lb-in	9.67	9.51	9.38
	Rated Speed		Nrtd	rpm	1800	2900	3800
	Rated Power (speed) (1)(2)(4)		Prtd	kW	0.206	0.326	0.422
Hp				0.276	0.438	0.565	
240 V AC	Rated Torque (speed) (1)(2)(4)		Trtd	Nm	1.04	0.991	0.955
				lb-in	9.21	8.77	8.45
	Rated Speed		Nrtd	rpm	4400	6600	8000
	Rated Power (speed) (1)(2)(4)		Prtd	kW	0.480	0.685	0.800
Hp				0.643	0.919	1.07	
400 V AC	Rated Torque (speed) (1)(2)(4)		Trtd	Nm	0.956	0.938	
				lb-in	8.46	8.30	
	Rated Speed		Nrtd	rpm	7800	8000	
	Rated Power (speed) (1)(2)(4)		Prtd	kW	0.781	0.786	
Hp				1.048	1.05		
480 V AC	Rated Torque (speed) (1)(2)(4)		Trtd	Nm	0.944	0.928	
				lb-in	8.36	8.21	
	Rated Speed		Nrtd	rpm	8000	8000	
	Rated Power (speed) (1)(2)(4)		Prtd	kW	0.791	0.777	
Hp				1.06	1.04		

UN	Parameter	Tolerance	Symbol	Units	AKM2G		
					22C	22D	22E
	Torque Constant (1)	+/- 10%	Kt	Nm/Arms	0.676	0.472	0.384
				lb-in/Arms	5.99	4.18	3.40
	Back EMF Constant (6)	+/- 10%	Ke	Vrms/krpm	44.2	30.9	25.1
	Motor Constant (1)	Nom	Km	Nm/ \sqrt{W}	0.144	0.144	0.145
				lb-in/ \sqrt{W}	1.28	1.28	1.28
	Resistance (line-line) (6)	+/- 10%	Rm	Ω	14.7	7.11	4.69
	Inductance Q-Axis (line-line)		Lqll	mH	37.9	18.5	12.2
	Inductance D-Axis (line-line)		Ldll	mH	TBD	TBD	TBD
	Inductance Saturation Current		Lisat	Arms	13	19	24
	Maximum Demagnetization Current		Midpeak	Arms	TBD	TBD	TBD
Parameter		Symbol	Units	AKM2G			
				22C	22D	22E	
Mechanical Data							
Inertia (incl. Resolver feedback) (3)	Jm			kgcm ²	0.155		
				lb-in-s ²	1.37E-04		
Optional Brake Inertia (additional)	Jm			kgcm ²	0.040		
				lb-in-s ²	3.54E-05		
Weight (8)	W			kg	1.4		
				lb	3.1		
Static Friction (1)	Tf			Nm	0.011		
				lb-in	0.10		
Viscous Damping (1)	Kdv			Nm/krpm	0.0030		
				lb-in/krpm	0.027		
Thermal Time Constant	TCT			mins.	10.8		
Thermal Resistance	Rthw-a			$^{\circ}\text{C}/\text{W}$	1.14		
Pole Pairs	PP				3		
Heatsink Size					10" x 10" x 1/4" Aluminum Plate		

1. Motor winding at temp. rise, $\delta T = 100^{\circ}\text{C}$, at 40°C ambient
2. All data referenced to sinusoidal commutation
3. Add parking brake if applicable for total inertia
4. Motor with resolver feedback and standard heat sink
5. May be limited at some values of V_{bus}
6. Measured at 25°C
7. See de-rate chart for the de-rate of different motor options.
8. Brake motor adds 0.45 kg [1.0 lbs]
9. Shaft seal increases Static Friction by 0.020 Nm [0.21 lb-in]

Brake options are listed in chapter "Technical Data Brakes" from [Technical Data Brakes](#).

7.2.3.1 AKM2G-22 Derates for Different Options

Note: Derate information is for general estimation only. For the most accurate information for your motor use the online Performance Curve Generator located at pcgh.kollmorgen.com, the AKM2G Performance Curves document available for download at www.kollmorgen.com/sites/default/files/public_downloads/AKM2G%20Performance%20Curves_0.pdf, or refer to Kollmorgen's Motioneering Software Tool at www.kollmorgen.com/en-us/service-and-support/technical/motioneering-online/.

De-rates are referenced to the Max Continuous Torque ΔT wdg. = 100°C

Options - No Brake	Speed: RPM								
	0	1000	2000	3000	4000	5000	6000	7000	8000
Resolver	100.0%	98.5%	96.5%	94.5%	92.4%	90.2%	87.9%	85.5%	83.1%
Resolver/Seal	98.2%	96.6%	94.6%	92.5%	90.4%	88.1%	85.8%	83.4%	80.9%
SFD	100.0%	98.5%	96.5%	94.5%	92.4%	90.2%	87.9%	85.5%	83.1%
SFD/Seal	98.2%	96.6%	94.6%	92.5%	90.4%	88.1%	85.8%	83.1%	79.7%
DSL	100.0%	98.5%	96.5%	94.5%	92.4%	90.2%	87.9%	85.5%	83.1%
DSL/seal	98.2%	96.6%	94.6%	92.5%	90.4%	88.1%	85.3%	81.9%	78.4%
EnDat2.2	97.1%	95.2%	92.7%	90.0%	87.3%	84.4%	81.3%	78.2%	74.8%
EnDat2.2/Seal	95.2%	93.0%	90.1%	87.1%	83.9%	80.5%	77.0%	73.2%	69.3%

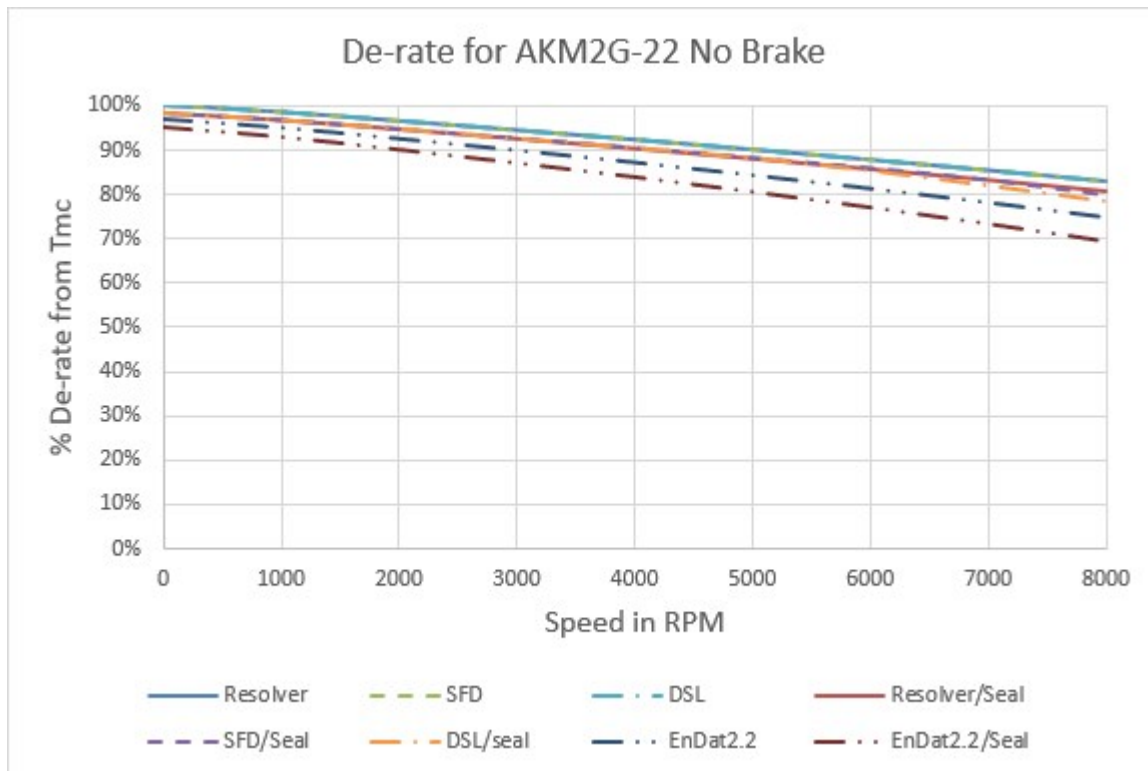

De-rates are referenced to the Max Continuous Torque ΔT wdg. = 100°C

Options - Brake	Speed: RPM								
	0	1000	2000	3000	4000	5000	6000	7000	8000
Resolver	98.9%	97.4%	95.4%	93.3%	91.2%	89.0%	86.7%	84.4%	81.9%
Resolver/Seal	97.1%	95.5%	93.5%	91.4%	89.2%	87.0%	84.5%	81.1%	77.6%
SFD	98.9%	97.4%	95.4%	93.3%	91.2%	89.0%	86.7%	84.4%	81.9%
SFD/Seal	97.1%	95.5%	93.5%	91.4%	89.2%	87.0%	84.5%	81.1%	77.6%
DSL	98.9%	97.4%	95.4%	93.3%	91.2%	89.0%	86.7%	84.4%	81.9%
DSL/seal	97.1%	95.5%	93.5%	91.4%	89.2%	87.0%	84.5%	81.1%	77.6%
EnDat2.2	95.8%	93.8%	91.3%	88.6%	85.8%	82.9%	79.8%	76.6%	73.2%
EnDat2.2/Seal	93.9%	91.7%	88.7%	85.6%	82.4%	79.0%	75.4%	71.6%	67.5%

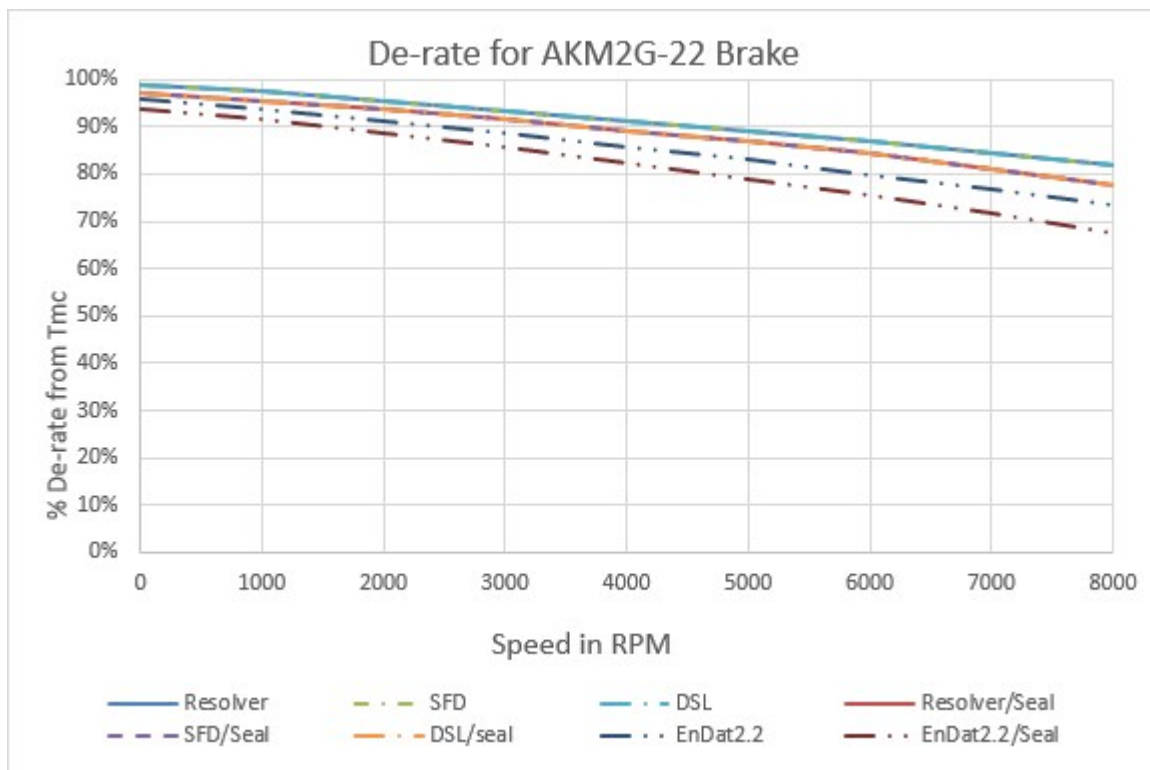

Note: For EnDat feedback motors acceleration of the motor is limited to $\leq 1 \cdot 10^5$ rad/s². The connected servo drive may further limit this value.

7.2.4 Technical Data AKM2G-22L

U _N	Parameter	Tolerance	Symbol	Units	AKM2G		
					KL	NL	PL
Electrical data							
	Max. Rated DC Bus Voltage	Max	V bus	V dc	170	170	170
	Max. Continuous Torque for ΔT winding = 100°C (1)(2)(4)	Nom	Tmc	Nm	1.10	1.11	1.12
				lb-in	9.76	9.85	9.92
	Max. Continuous Current for ΔT winding = 100°C (1)(2)(4)	Nom	Imc	Arms	9.83	15.2	18.9
	Max. Continuous Torque for ΔT winding = 60°C (2)(4)	Nom	Tmc	Nm	0.855	0.863	0.871
				lb-in	7.57	7.64	7.70
	Max. mechanical speed (5)	Nom	Nmax	rpm	8000	8000	8000
	Peak Torque (1)(2)(4)	Nom	Tp	Nm	3.32	3.34	3.35
lb-in				29.4	29.5	29.6	
Peak Current	Nom	Ip	Arms	39.3	60.8	75.6	
24 V DC	Rated Torque (speed) (1)(2)(4)		Trtd	Nm		1.08	1.08
				lb-in		9.59	9.55
	Rated Speed		Nrtd	rpm		2200	2900
	Rated Power (speed) (1)(2)(4)		Prtd	kW		0.250	0.328
Hp					0.335	0.439	
48 V DC	Rated Torque (speed) (1)(2)(4)		Trtd	Nm	1.05	1.02	0.997
				lb-in	9.31	9.02	8.82
	Rated Speed		Nrtd	rpm	3300	5200	6400
	Rated Power (speed) (1)(2)(4)		Prtd	kW	0.363	0.555	0.67
Hp				0.487	0.744	0.896	
72 V DC	Rated Torque (speed) (1)(2)(4)		Trtd	Nm	1.01	0.944	0.942
				lb-in	8.92	8.35	8.33
	Rated Speed		Nrtd	rpm	5300	8000	8000
	Rated Power (speed) (1)(2)(4)		Prtd	kW	0.559	0.791	0.789
Hp				0.750	1.06	1.06	
96 V DC	Rated Torque (speed) (1)(2)(4)		Trtd	Nm	0.956		
				lb-in	8.46		
	Rated Speed		Nrtd	rpm	7300		
	Rated Power (speed) (1)(2)(4)		Prtd	kW	0.731		
Hp				0.980			

UN	Parameter	Tolerance	Symbol	Units	AKM2G		
					KL	NL	PL
	Torque Constant (1)	+/- 10%	Kt	Nm/Arms	0.113	0.0740	0.0599
				lb-in/Arms	1.00	0.655	0.530
	Back EMF Constant (6)	+/- 10%	Ke	Vrms/krpm	7.41	4.84	3.92
	Motor Constant (1)	Nom	Km	Nm/ \sqrt{W}	0.143	0.145	0.146
				lb-in/ \sqrt{W}	1.27	1.28	1.29
	Resistance (line-line) (6)	+/- 10%	Rm	Ω	0.416	0.174	0.112
	Inductance Q-Axis (line-line)		Lqll	mH	1.06	0.45	0.30
	Inductance D-Axis (line-line)		Ldll	mH	TBD	TBD	TBD
	Inductance Saturation Current		Lisat	Arms	79	121	150
	Maximum Demagnetization Current		Midpeak	Arms	TBD	TBD	TBD

Parameter	Symbol	Units	AKM2G		
			KL	NL	PL
Mechanical Data					
Inertia (incl. Resolver feedback) (3)	Jm	kgcm ²	0.155		
		lb-in-s ²	1.37E-04		
Optional Brake Inertia (additional)	Jm	kgcm ²	0.040		
		lb-in-s ²	3.54E-05		
Weight (8)	W	kg	1.4		
		lb	3.1		
Static Friction (1)	Tf	Nm	0.011		
		lb-in	0.10		
Viscous Damping (1)	Kdv	Nm/krpm	0.0030		
		lb-in/krpm	0.027		
Thermal Time Constant	TCT	mins.	10.8		
Thermal Resistance	Rthw-a	°C/W	1.14		
Pole Pairs	PP		3		
Heatsink Size			10" x 10" x 1/4" Aluminum Plate		

1. Motor winding at temp. rise, $\delta T = 100^{\circ}\text{C}$, at 40°C ambient
2. All data referenced to sinusoidal commutation
3. Add parking brake if applicable for total inertia
4. Motor with resolver feedback and standard heat sink
5. May be limited at some values of V_{bus}
6. Measured at 25°C
7. See de-rate chart for the de-rate of different motor options.
8. Brake motor adds 0.45 kg [1.0 lbs]
9. Shaft seal increases Static Friction by 0.020 Nm [0.21 lb-in]

Brake options are listed in chapter "Technical Data Brakes" from [Technical Data Brakes](#).

7.2.4.1 AKM2G-22L Derates for Different Options

Note: Derate information is for general estimation only. For the most accurate information for your motor use the online Performance Curve Generator located at pcgh.kollmorgen.com, the AKM2G Performance Curves document available for download at www.kollmorgen.com/sites/default/files/public_downloads/AKM2G%20Performance%20Curves_0.pdf, or refer to Kollmorgen's Motioneering Software Tool at www.kollmorgen.com/en-us/service-and-support/technical/motioneering-online/.

De-rates are referenced to the Max Continuous Torque ΔT wdg. = 100°C

Options - No Brake	Speed: RPM								
	0	1000	2000	3000	4000	5000	6000	7000	8000
SFD	100.0%	99.1%	97.3%	95.3%	93.3%	91.2%	89.0%	86.8%	84.5%
SFD/Seal	98.2%	97.3%	95.4%	93.4%	91.3%	89.2%	87.0%	84.6%	81.3%
DSL	100.0%	99.1%	97.3%	95.3%	93.3%	91.2%	89.0%	86.8%	84.5%
DSL/seal	98.2%	97.3%	95.4%	93.4%	91.3%	89.2%	86.6%	83.4%	80.0%
EnDat2.2	97.1%	95.9%	93.5%	91.0%	88.4%	85.6%	82.7%	79.7%	76.5%
EnDat2.2/Seal	95.3%	93.7%	91.0%	88.1%	85.0%	81.8%	78.4%	74.8%	71.0%

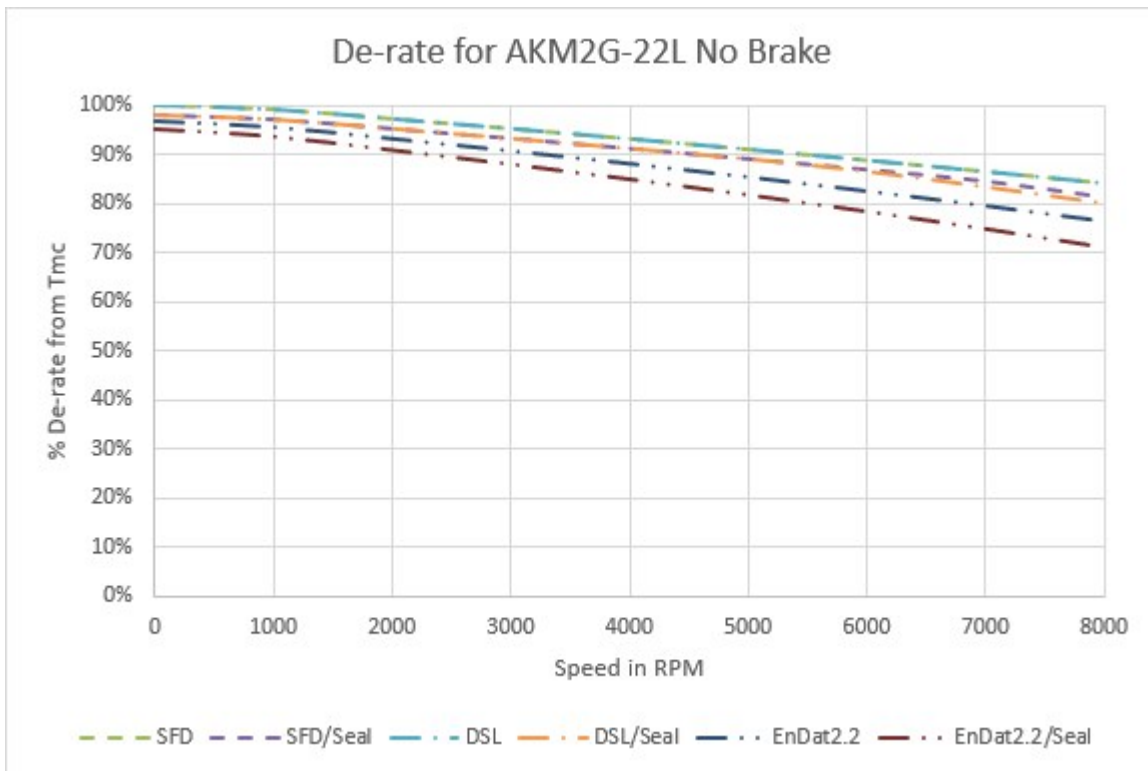

De-rates are referenced to the Max Continuous Torque ΔT wdg. = 100°C

Options - Brake	Speed: RPM								
	0	1000	2000	3000	4000	5000	6000	7000	8000
SFD	98.9%	98.0%	96.1%	94.2%	92.2%	90.1%	87.9%	85.6%	83.3%
SFD/Seal	97.1%	96.2%	94.3%	92.3%	90.2%	88.0%	85.8%	82.6%	79.2%
DSL	98.9%	98.0%	96.1%	94.2%	92.2%	90.1%	87.9%	85.6%	83.3%
DSL/seal	97.1%	96.2%	94.3%	92.3%	90.2%	88.0%	85.8%	82.6%	79.2%
EnDat2.2	95.8%	94.5%	92.1%	89.6%	86.9%	84.2%	81.2%	78.2%	74.9%
EnDat2.2/Seal	93.9%	92.4%	89.6%	86.6%	83.5%	80.3%	76.8%	73.2%	69.3%

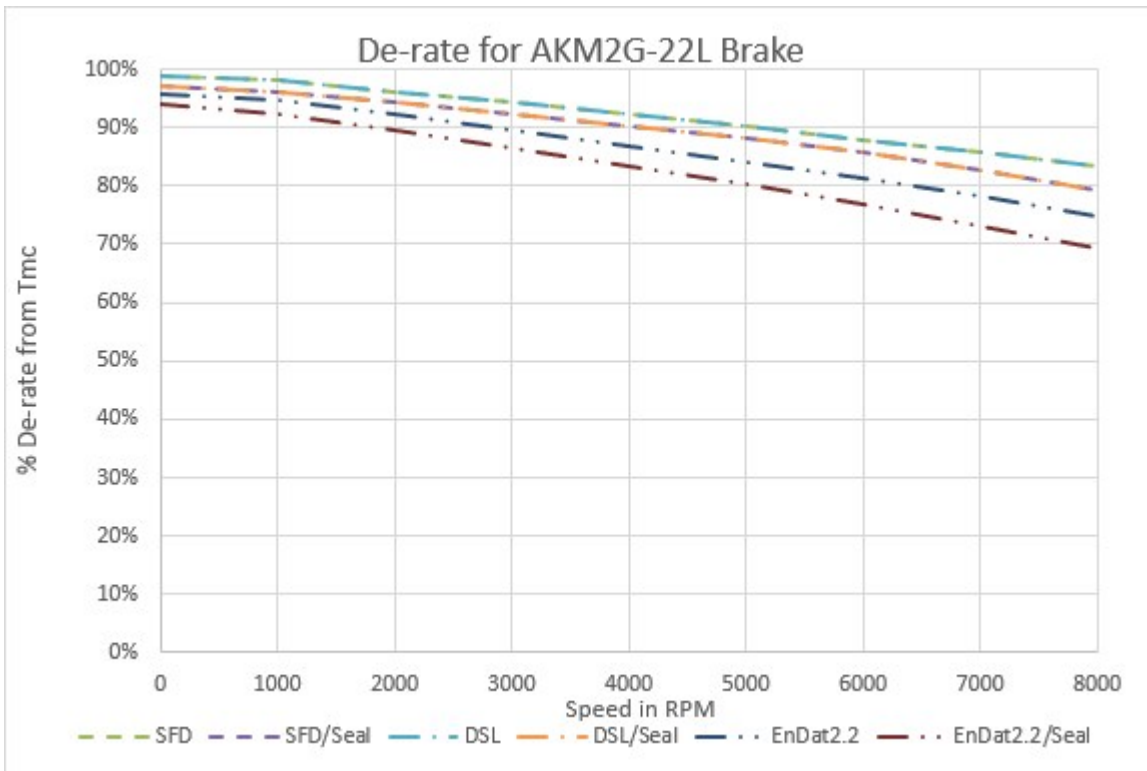

Note: For EnDat feedback motors acceleration of the motor is limited to $\leq 1 \cdot 10^5$ rad/s². The connected servo drive may further limit this value.

7.2.5 Technical Data AKM2G-23

U _N	Parameter	Tolerance	Symbol	Units	AKM2G		
					23D	23E	23F
Electrical data							
	Max. Rated DC Bus Voltage	Max	V bus	V dc	480	480	240
	Max. Continuous Torque for ΔT winding = 100°C (1)(2)(4)	Nom	Tmc	Nm	1.48	1.48	1.50
				lb-in	13.1	13.1	13.3
	Max. Continuous Current for ΔT winding = 100°C (1)(2)(4)	Nom	Imc	Arms	2.11	2.92	4.07
	Max. Continuous Torque for ΔT winding = 60°C (2)(4)	Nom	Tmc	Nm	1.150	1.151	1.168
				lb-in	10.2	10.2	10.3
	Max. mechanical speed (5)	Nom	Nmax	rpm	8000	8000	8000
	Peak Torque (1)(2)(4)	Nom	Tp	Nm	4.69	4.69	4.74
				lb-in	41.5	41.5	41.9
	Peak Current	Nom	Ip	Arms	8.44	11.7	16.3
24 V DC	Rated Torque (speed) (1)(2)(4)		Trtd	Nm	1.45	1.42	1.39
				lb-in	12.8	12.5	12.3
	Rated Speed		Nrtd	rpm	1800	2800	4100
	Rated Power (speed) (1)(2)(4)		Prtd	kW	0.273	0.416	0.599
Hp				0.366	0.557	0.803	
48 V DC	Rated Torque (speed) (1)(2)(4)		Trtd	Nm	1.37	1.29	1.22
				lb-in	12.1	11.4	10.8
	Rated Speed		Nrtd	rpm	4300	6200	8000
	Rated Power (speed) (1)(2)(4)		Prtd	kW	0.615	0.839	1.02
Hp				0.825	1.12	1.37	
72 V DC	Rated Torque (speed) (1)(2)(4)		Trtd	Nm	1.23	1.19	
				lb-in	10.9	10.5	
	Rated Speed		Nrtd	rpm	7600	8000	
	Rated Power (speed) (1)(2)(4)		Prtd	kW	0.977	0.993	
Hp				1.31	1.33		
96 V DC	Rated Torque (speed) (1)(2)(4)		Trtd	Nm	1.20	1.17	
				lb-in	10.6	10.3	
	Rated Speed		Nrtd	rpm	8000	8000	
	Rated Power (speed) (1)(2)(4)		Prtd	kW	1.00	0.978	
Hp				1.35	1.31		

UN	Parameter	Tolerance	Symbol	Units	AKM2G		
					23D	23E	23F
	Torque Constant (1)	+/- 10%	Kt	Nm/Arms	0.710	0.512	0.373
				lb-in/Arms	6.28	4.53	3.30
	Back EMF Constant (6)	+/- 10%	Ke	Vrms/krpm	46.1	33.3	24.2
	Motor Constant (1)	Nom	Km	Nm/ \sqrt{W}	0.187	0.187	0.190
				lb-in/ \sqrt{W}	1.66	1.66	1.68
	Resistance (line-line) (6)	+/- 10%	Rm	Ω	9.60	4.99	2.57
	Inductance Q-Axis (line-line)		Lqll	mH	26.5	13.8	7.32
	Inductance D-Axis (line-line)		Ldll	mH	TBD	TBD	TBD
	Inductance Saturation Current		Lisat	Arms	19	27	37
	Maximum Demagnetization Current		Midpeak	Arms	TBD	TBD	TBD

Parameter	Symbol	Units	AKM2G		
			23D	23E	23F
Mechanical Data					
Inertia (incl. Resolver feedback) (3)	Jm	kgcm ²	0.217		
		lb-in-s ²	1.92E-04		
Optional Brake Inertia (additional)	Jm	kgcm ²	0.040		
		lb-in-s ²	3.54E-05		
Weight (8)	W	kg	1.7		
		lb	3.7		
Static Friction (1)	Tf	Nm	0.015		
		lb-in	0.13		
Viscous Damping (1)	Kdv	Nm/krpm	0.0045		
		lb-in/krpm	0.040		
Thermal Time Constant	TCT	mins.	11.9		
Thermal Resistance	Rthw-a	°C/W	1.07		
Pole Pairs	PP		3		
Heatsink Size			10" x 10" x 1/4" Aluminum Plate		

1. Motor winding at temp. rise, $\delta T = 100^{\circ}\text{C}$, at 40°C ambient
2. All data referenced to sinusoidal commutation
3. Add parking brake if applicable for total inertia
4. Motor with resolver feedback and standard heat sink
5. May be limited at some values of V_{bus}
6. Measured at 25°C
7. See de-rate chart for the de-rate of different motor options.
8. Brake motor adds 0.45 kg [1.0 lbs]
9. Shaft seal increases Static Friction by 0.020 Nm [0.21 lb-in]

Brake options are listed in chapter "Technical Data Brakes" from [Technical Data Brakes](#).

7.2.5.1 AKM2G-23 Derates for Different Options

Note: Derate information is for general estimation only. For the most accurate information for your motor use the online Performance Curve Generator located at pcgh.kollmorgen.com, the AKM2G Performance Curves document available for download at www.kollmorgen.com/sites/default/files/public_downloads/AKM2G%20Performance%20Curves_0.pdf, or refer to Kollmorgen's Motioneering Software Tool at www.kollmorgen.com/en-us/service-and-support/technical/motioneering-online/.

De-rates are referenced to the Max Continuous Torque ΔT wdg. = 100°C

Options - No Brake	Speed: RPM								
	0	1000	2000	3000	4000	5000	6000	7000	8000
Resolver	100.0%	98.1%	95.7%	93.2%	90.6%	87.8%	85.0%	82.0%	78.9%
Resolver/Seal	98.6%	96.8%	94.3%	91.7%	89.1%	86.3%	83.4%	80.4%	77.2%
SFD	100.0%	98.1%	95.7%	93.2%	90.6%	87.8%	84.5%	80.9%	77.1%
SFD/Seal	98.6%	96.8%	94.3%	91.7%	88.9%	85.4%	81.7%	77.7%	73.5%
DSL	100.0%	98.1%	95.7%	93.2%	90.2%	86.8%	83.4%	79.7%	75.8%
DSL/seal	98.6%	96.8%	94.3%	91.3%	87.8%	84.3%	80.5%	76.5%	72.2%
EnDat2.2	94.5%	92.2%	89.1%	85.9%	82.5%	78.8%	75.0%	70.9%	66.5%
EnDat2.2/Seal	93.1%	90.6%	87.3%	83.7%	80.0%	76.0%	71.7%	67.2%	62.3%

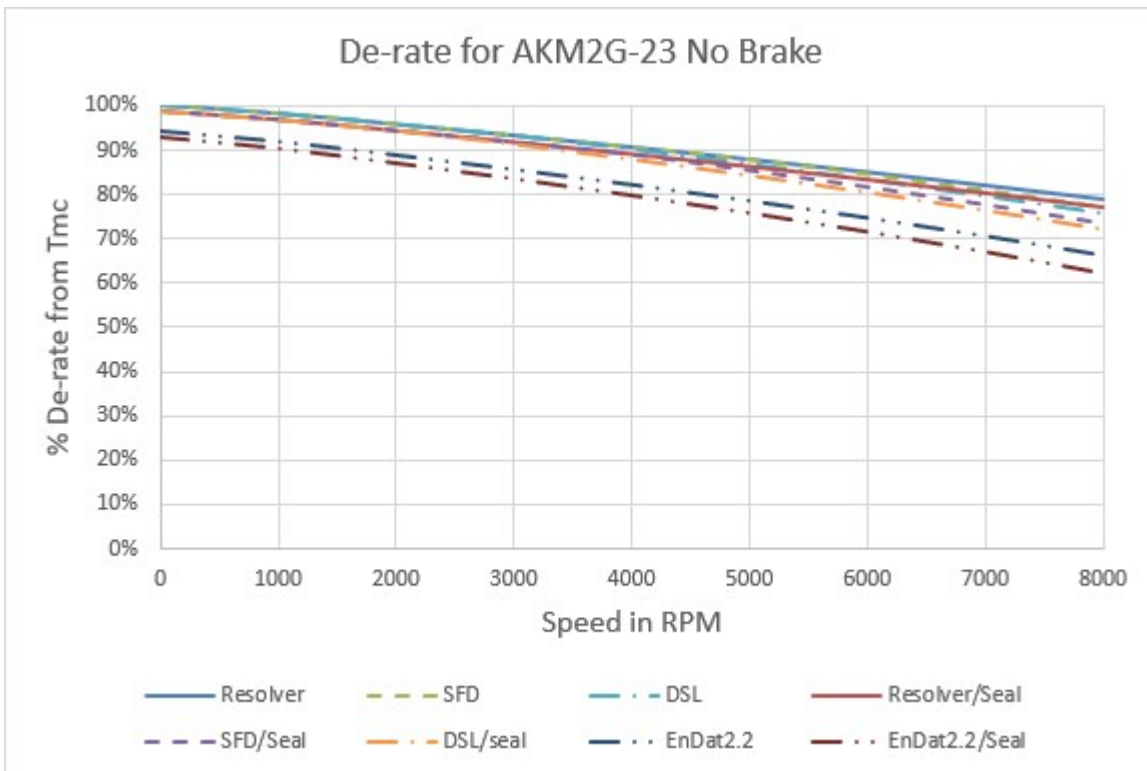

De-rates are referenced to the Max Continuous Torque ΔT wdg. = 100°C

Options - Brake	Speed: RPM								
	0	1000	2000	3000	4000	5000	6000	7000	8000
Resolver	99.1%	97.3%	94.8%	91.9%	88.8%	85.4%	81.9%	78.1%	74.2%
Resolver/Seal	97.8%	95.9%	93.2%	89.9%	86.4%	82.8%	78.9%	74.8%	70.5%
SFD	99.1%	97.3%	94.8%	91.9%	88.8%	85.4%	81.9%	78.1%	74.2%
SFD/Seal	97.8%	95.9%	93.2%	89.9%	86.4%	82.8%	78.9%	74.8%	70.5%
DSL	99.1%	97.3%	94.8%	91.9%	88.8%	85.4%	81.9%	78.1%	74.2%
DSL/seal	97.8%	95.9%	93.2%	89.9%	86.4%	82.8%	78.9%	74.8%	70.5%
EnDat2.2	92.5%	90.1%	87.0%	83.7%	80.2%	76.5%	72.5%	68.3%	63.8%
EnDat2.2/Seal	91.1%	88.5%	85.1%	81.5%	77.6%	73.5%	69.2%	64.5%	59.4%

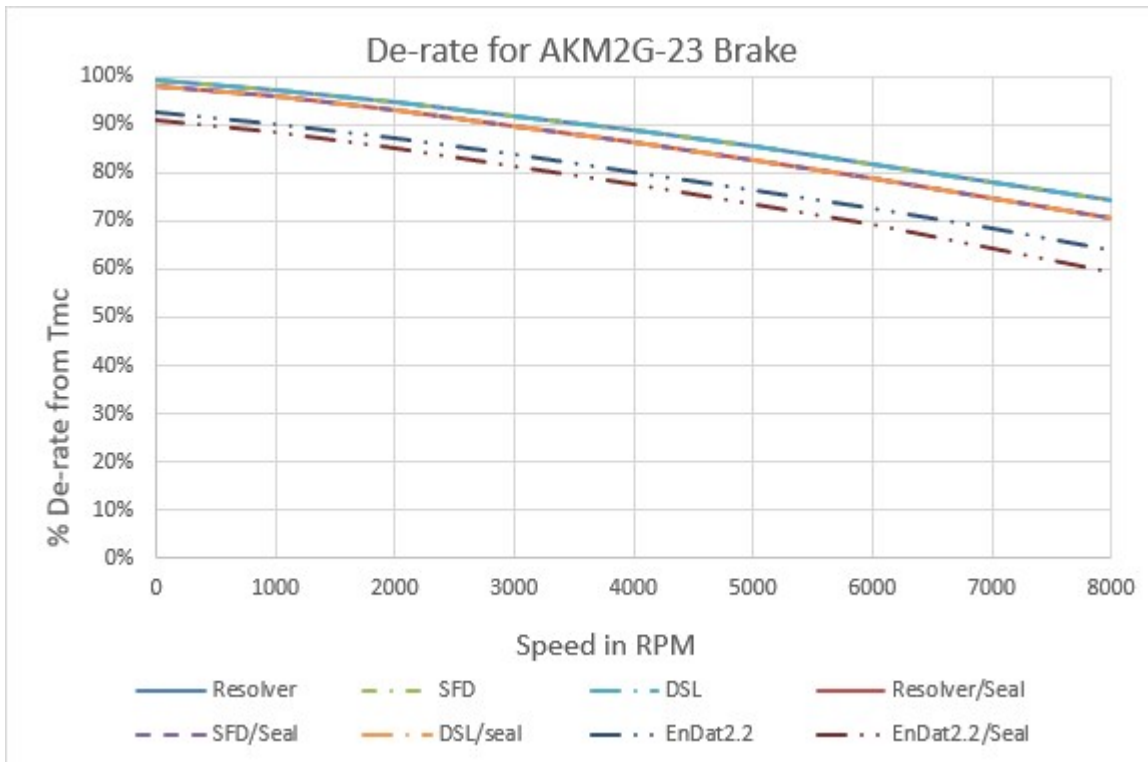

Note: For EnDat feedback motors acceleration of the motor is limited to $\leq 1 \cdot 10^5$ rad/s². The connected servo drive may further limit this value.

7.2.6 Technical Data AKM2G-23L

UN	Parameter	Tolerance	Symbol	Units	AKM2G		
					KL	ML	PL
Electrical data							
	Max. Rated DC Bus Voltage	Max	V bus	V dc	170	170	170
	Max. Continuous Torque for ΔT winding = 100°C (1)(2)(4)	Nom	Tmc	Nm	1.48	1.49	1.50
				ib-in	13.1	13.2	13.3
	Max. Continuous Current for ΔT winding = 100°C (1)(2)(4)	Nom	Imc	Arms	9.82	13.5	19.2
	Max. Continuous Torque for ΔT winding = 60°C (2)(4)	Nom	Tmc	Nm	1.15	1.15	1.17
				lb-in	10.1	10.2	10.3
	Max. mechanical speed (5)	Nom	Nmax	rpm	8000	8000	8000
	Peak Torque (1)(2)(4)	Nom	Tp	Nm	4.69	4.70	4.73
				lb-in	41.5	41.6	41.9
	Peak Current	Nom	Ip	Arms	39.3	54.0	76.9
24 V DC	Rated Torque (speed) (1)(2)(4)		Trtd	Nm			1.46
				lb-in			12.9
	Rated Speed		Nrtd	rpm			1900
	Rated Power (speed) (1)(2)(4)		Prtd	kW			0.291
Hp						0.390	
48 V DC	Rated Torque (speed) (1)(2)(4)		Trtd	Nm	1.42	1.40	1.35
				lb-in	12.6	12.4	12.0
	Rated Speed		Nrtd	rpm	2400	3400	4900
	Rated Power (speed) (1)(2)(4)		Prtd	kW	0.358	0.498	0.694
Hp				0.480	0.668	0.930	
72 V DC	Rated Torque (speed) (1)(2)(4)		Trtd	Nm	1.37	1.31	1.18
				lb-in	12.1	11.6	10.4
	Rated Speed		Nrtd	rpm	4000	5500	8000
	Rated Power (speed) (1)(2)(4)		Prtd	kW	0.574	0.755	0.989
Hp				0.770	1.01	1.33	
96 V DC	Rated Torque (speed) (1)(2)(4)		Trtd	Nm	1.30	1.19	
				lb-in	11.5	10.6	
	Rated Speed		Nrtd	rpm	5500	7600	
	Rated Power (speed) (1)(2)(4)		Prtd	kW	0.751	0.951	
Hp				1.01	1.27		

UN	Parameter	Tolerance	Symbol	Units	AKM2G		
					KL	ML	PL
	Torque Constant (1)	+/- 10%	Kt	Nm/Arms	0.152	0.111	0.0789
				lb-in/Arms	1.35	0.985	0.698
	Back EMF Constant (6)	+/- 10%	Ke	Vrms/krpm	9.88	7.23	5.12
	Motor Constant (1)	Nom	Km	Nm/ \sqrt{W}	0.186	0.188	0.190
				lb-in/ \sqrt{W}	1.65	1.66	1.68
	Resistance (line-line) (6)	+/- 10%	Rm	Ω	0.444	0.234	0.115
	Inductance Q-Axis (line-line)		Lqll	mH	1.22	0.65	0.33
	Inductance D-Axis (line-line)		Ldll	mH	TBD	TBD	TBD
	Inductance Saturation Current		Lisat	Arms	89	121	171
	Maximum Demagnetization Current		Midpeak	Arms	TBD	TBD	TBD

Parameter	Symbol	Units	AKM2G		
			KL	ML	PL
Mechanical Data					
Inertia (incl. Resolver feedback) (3)	Jm	kgcm ²	0.217		
		lb-in-s ²	1.92E-04		
Optional Brake Inertia (additional)	Jm	kgcm ²	0.040		
		lb-in-s ²	3.54E-05		
Weight (8)	W	kg	1.7		
		lb	3.7		
Static Friction (1)	Tf	Nm	0.015		
		lb-in	0.13		
Viscous Damping (1)	Kdv	Nm/krpm	0.0045		
		lb-in/krpm	0.040		
Thermal Time Constant	TCT	mins.	11.9		
Thermal Resistance	Rthw-a	°C/W	1.07		
Pole Pairs	PP		3		
Heatsink Size			10" x 10" x 1/4" Aluminum Plate		

1. Motor winding at temp. rise, $\delta T = 100^{\circ}\text{C}$, at 40°C ambient
2. All data referenced to sinusoidal commutation
3. Add parking brake if applicable for total inertia
4. Motor with resolver feedback and standard heat sink
5. May be limited at some values of V_{bus}
6. Measured at 25°C
7. See de-rate chart for the de-rate of different motor options.
8. Brake motor adds 0.45 kg [1.0 lbs]
9. Shaft seal increases Static Friction by 0.020 Nm [0.21 lb-in]

Brake options are listed in chapter "Technical Data Brakes" from [Technical Data Brakes](#).

7.2.6.1 AKM2G-23L Derates for Different Options

Note: Derate information is for general estimation only. For the most accurate information for your motor use the online Performance Curve Generator located at pcgh.kollmorgen.com, the AKM2G Performance Curves document available for download at www.kollmorgen.com/sites/default/files/public_downloads/AKM2G%20Performance%20Curves_0.pdf, or refer to Kollmorgen's Motioneering Software Tool at www.kollmorgen.com/en-us/service-and-support/technical/motioneering-online/.

De-rates are referenced to the Max Continuous Torque ΔT wdg. = 100°C

Options - No Brake	Speed: RPM								
	0	1000	2000	3000	4000	5000	6000	7000	8000
SFD	100.0%	98.4%	96.2%	93.9%	91.6%	89.1%	86.5%	83.3%	79.9%
SFD/Seal	98.7%	97.0%	94.8%	92.5%	90.1%	87.0%	83.7%	80.2%	76.4%
DSL	100.0%	98.4%	96.2%	93.9%	91.4%	88.5%	85.4%	82.1%	78.6%
DSL/seal	98.7%	97.0%	94.8%	92.2%	89.2%	85.9%	82.5%	79.0%	75.2%
EnDat2.2	94.6%	92.5%	89.8%	87.0%	83.9%	80.7%	77.3%	73.7%	69.8%
EnDat2.2/Seal	93.2%	91.0%	88.0%	84.8%	81.5%	77.9%	74.2%	70.2%	65.9%

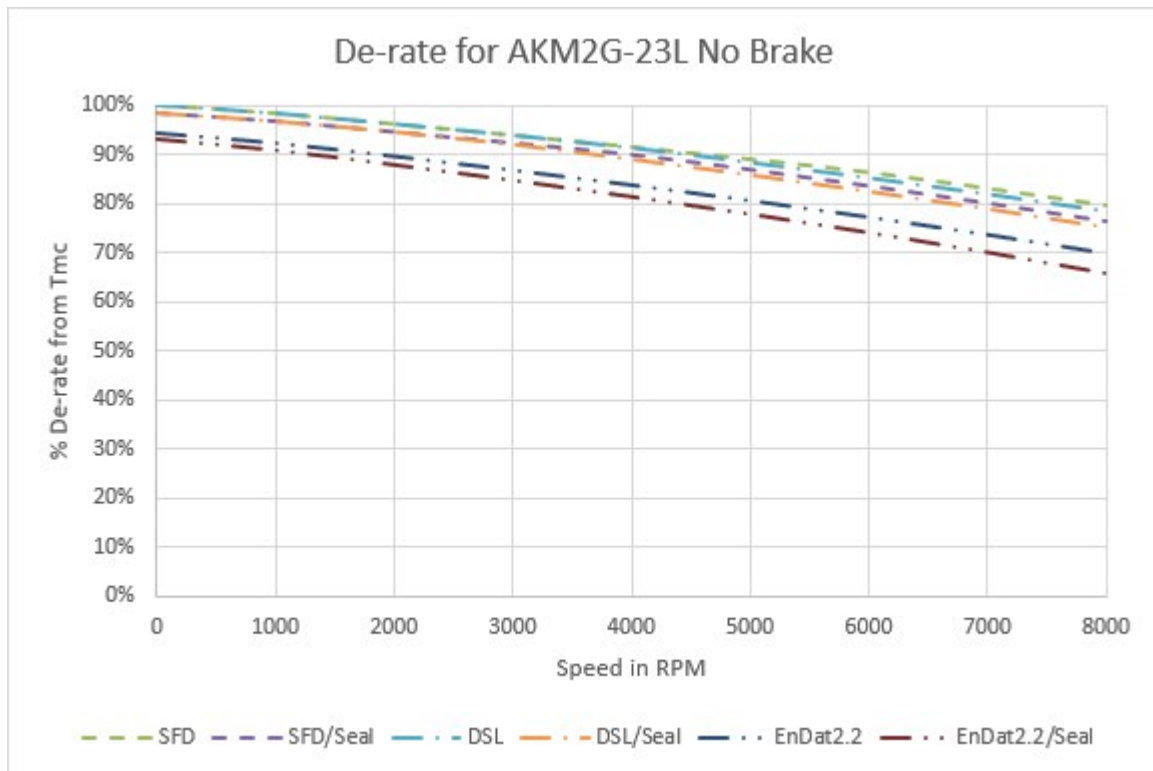

De-rates are referenced to the Max Continuous Torque ΔT wdg. = 100°C

Options - Brake	Speed: RPM								
	0	1000	2000	3000	4000	5000	6000	7000	8000
SFD	99.1%	97.5%	95.3%	92.9%	90.0%	87.1%	83.9%	80.6%	77.1%
SFD/Seal	97.8%	96.1%	93.8%	90.9%	87.8%	84.5%	81.0%	77.4%	73.5%
DSL	99.1%	97.5%	95.3%	92.9%	90.0%	87.1%	83.9%	80.6%	77.1%
DSL/seal	97.8%	96.1%	93.8%	90.9%	87.8%	84.5%	81.0%	77.4%	73.5%
EnDat2.2	92.6%	90.5%	87.7%	84.8%	81.7%	78.4%	74.9%	71.2%	67.3%
EnDat2.2/Seal	91.2%	88.9%	85.9%	82.6%	79.2%	75.6%	71.7%	67.6%	63.1%

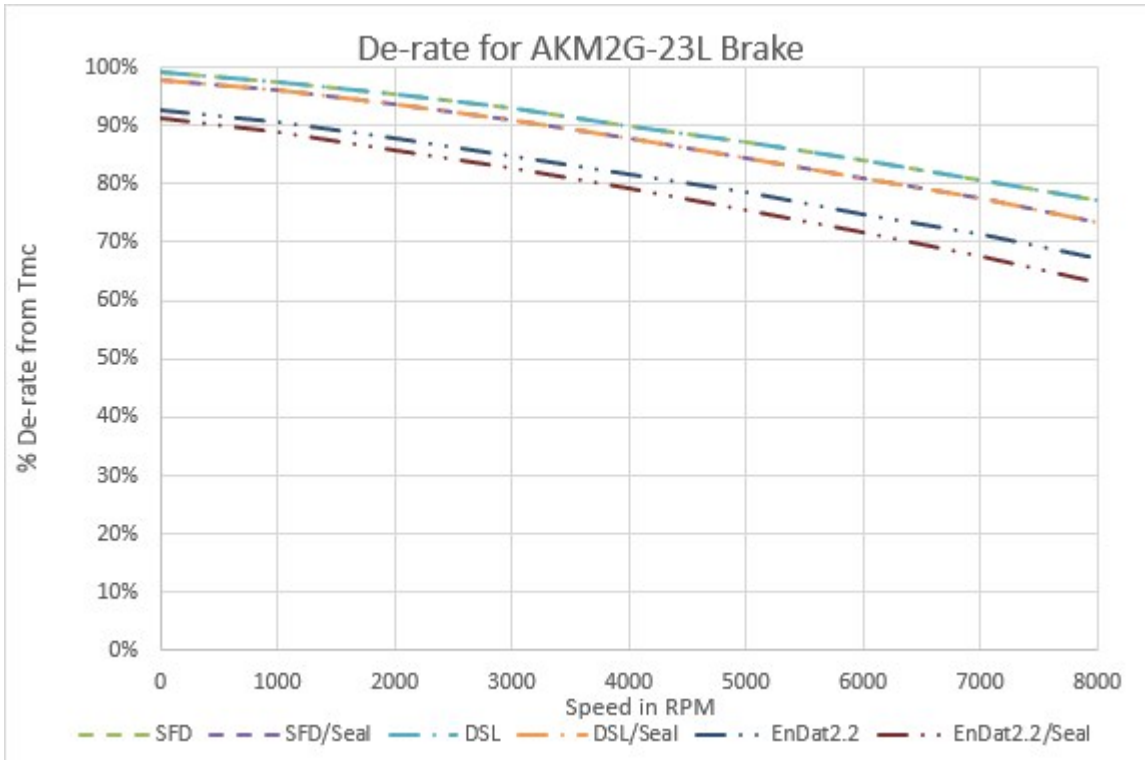

Note: For EnDat feedback motors acceleration of the motor is limited to $\leq 1 \cdot 10^5$ rad/s². The connected servo drive may further limit this value.

7.2.7 Technical Data AKM2G-24

UN	Parameter	Tolerance	Symbol	Units	AKM2G		
					24D	24E	24F
Electrical data							
	Max. Rated Equivalent Line Voltage	Max	V bus	V ac	480	480	480
	Max. Continuous Torque for ΔT winding = 100°C (1)(2)(4)	Nom	Tmc	Nm	1.80	1.81	1.83
				lb-in	16.0	16.0	16.2
	Max. Continuous Current for ΔT winding = 100°C (1)(2)(4)	Nom	Imc	Arms	2.11	2.92	4.11
	Max. Continuous Torque for ΔT winding = 60°C (2)(4)	Nom	Tmc	Nm	1.40	1.41	1.43
				lb-in	12.4	12.5	12.6
	Max. mechanical speed (5)	Nom	Nmax	rpm	8000	8000	8000
	Peak Torque (1)(2)(4)	Nom	Tp	Nm	5.93	5.95	6.00
				lb-in	52.5	52.6	53.1
	Peak Current	Nom	Ip	Arms	8.45	11.7	16.4
120 V AC	Rated Torque (speed) (1)(2)(4)		Trtd	Nm	1.76	1.74	1.71
				lb-in	15.6	15.4	15.2
	Rated Speed		Nrtd	rpm	1500	2300	3400
	Rated Power (speed) (1)(2)(4)		Prtd	kW	0.277	0.419	0.610
Hp				0.371	0.562	0.818	
240 V AC	Rated Torque (speed) (1)(2)(4)		Trtd	Nm	1.67	1.60	1.47
				lb-in	14.8	14.1	13.0
	Rated Speed		Nrtd	rpm	3600	5100	7300
	Rated Power (speed) (1)(2)(4)		Prtd	kW	0.629	0.853	1.13
Hp				0.844	1.14	1.51	
400 V AC	Rated Torque (speed) (1)(2)(4)		Trtd	Nm	1.51	1.39	1.36
				lb-in	13.4	12.3	12.0
	Rated Speed		Nrtd	rpm	6300	8000	8000
	Rated Power (speed) (1)(2)(4)		Prtd	kW	0.999	1.16	1.14
Hp				1.34	1.56	1.52	
480 V AC	Rated Torque (speed) (1)(2)(4)		Trtd	Nm	1.42	1.36	1.32
				lb-in	12.59	12.06	11.68
	Rated Speed		Nrtd	rpm	7600	8000	8000
	Rated Power (speed) (1)(2)(4)		Prtd	kW	1.13	1.14	1.11
Hp				1.52	1.53	1.48	

UN	Parameter	Tolerance	Symbol	Units	AKM2G		
					24D	24E	24F
	Torque Constant (1)	+/- 10%	Kt	Nm/Arms	0.863	0.627	0.451
				lb-in/Arms	7.64	5.55	3.99
	Back EMF Constant (6)	+/- 10%	Ke	Vrms/krpm	55.7	40.5	29.1
	Motor Constant (1)	Nom	Km	Nm/ \sqrt{W}	0.225	0.226	0.229
				lb-in/ \sqrt{W}	1.99	2.00	2.03
	Resistance (line-line) (6)	+/- 10%	Rm	Ω	9.84	5.15	2.58
	Inductance Q-Axis (line-line)		Lqll	mH	28.4	15.0	7.75
	Inductance D-Axis (line-line)		Ldll	mH	TBD	TBD	TBD
	Inductance Saturation Current		Lisat	Arms	21	29	41
	Maximum Demagnetization Current		Midpeak	Arms	TBD	TBD	TBD

Parameter	Symbol	Units	AKM2G		
			24D	24E	24F
Mechanical Data					
Inertia (incl. Resolver feedback) (3)	Jm	kgcm ²	0.279		
		lb-in-s ²	2.47E-04		
Optional Brake Inertia (additional)	Jm	kgcm ²	0.040		
		lb-in-s ²	3.54E-05		
Weight (8)	W	kg	2.0		
		lb	4.4		
Static Friction (1)	Tf	Nm	0.019		
		lb-in	0.17		
Viscous Damping (1)	Kdv	Nm/krpm	0.0060		
		lb-in/krpm	0.053		
Thermal Time Constant	TCT	mins.	13.0		
Thermal Resistance	Rthw-a	°C/W	1.04		
Pole Pairs	PP		3		
Heatsink Size			10" x 10" x 1/4" Aluminum Plate		

1. Motor winding at temp. rise, $\delta T = 100^{\circ}\text{C}$, at 40°C ambient
2. All data referenced to sinusoidal commutation
3. Add parking brake if applicable for total inertia
4. Motor with resolver feedback and standard heat sink
5. May be limited at some values of V_{bus}
6. Measured at 25°C
7. See de-rate chart for the de-rate of different motor options.
8. Brake motor adds 0.45 kg [1.0 lbs]
9. Shaft seal increases Static Friction by 0.020 Nm [0.21 lb-in]

Brake options are listed in chapter "Technical Data Brakes" from [Technical Data Brakes](#).

7.2.7.1 AKM2G-24 Derates for Different Options

Note: Derate information is for general estimation only. For the most accurate information for your motor use the online Performance Curve Generator located at pcgh.kollmorgen.com, the AKM2G Performance Curves document available for download at www.kollmorgen.com/sites/default/files/public_downloads/AKM2G%20Performance%20Curves_0.pdf, or refer to Kollmorgen's Motioneering Software Tool at www.kollmorgen.com/en-us/service-and-support/technical/motioneering-online/.

De-rates are referenced to the Max Continuous Torque ΔT wdg. = 100°C

Options - No Brake	Speed: RPM								
	0	1000	2000	3000	4000	5000	6000	7000	8000
Resolver	100.0%	97.6%	94.4%	91.1%	87.7%	84.0%	80.2%	76.2%	72.0%
Resolver/Seal	98.9%	96.4%	93.2%	89.8%	86.3%	82.6%	78.7%	74.6%	70.3%
SFD	100.0%	97.6%	94.4%	91.1%	87.3%	82.8%	78.0%	72.8%	67.2%
SFD/Seal	98.9%	96.4%	93.2%	89.8%	85.4%	80.7%	75.6%	70.0%	64.1%
DSL	100.0%	97.6%	94.4%	90.5%	86.2%	81.6%	76.7%	71.4%	65.7%
DSL/seal	98.9%	96.4%	93.1%	88.8%	84.3%	79.4%	74.2%	68.6%	62.4%
EnDat2.2	94.4%	91.3%	87.1%	82.6%	77.8%	72.7%	67.1%	60.9%	54.1%
EnDat2.2/Seal	93.3%	90.0%	85.6%	80.8%	75.8%	70.3%	64.3%	57.6%	

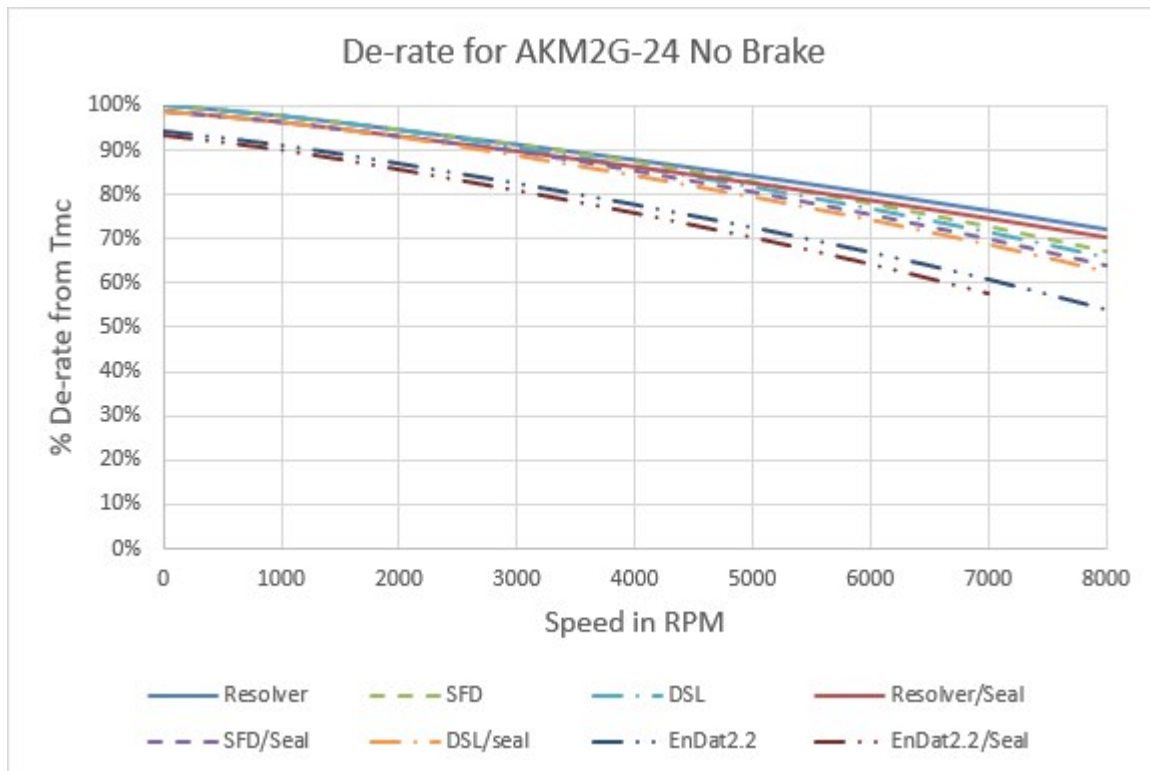

De-rates are referenced to the Max Continuous Torque ΔT wdg. = 100°C

Options - Brake	Speed: RPM								
	0	1000	2000	3000	4000	5000	6000	7000	8000
Resolver	99.3%	96.8%	93.1%	89.0%	84.6%	79.9%	74.9%	69.5%	63.6%
Resolver/Seal	98.1%	95.7%	91.6%	87.3%	82.6%	77.7%	72.3%	66.6%	60.3%
SFD	99.3%	96.8%	93.1%	89.0%	84.6%	79.9%	74.9%	69.5%	63.6%
SFD/Seal	98.1%	95.7%	91.6%	87.3%	82.6%	77.7%	72.3%	66.6%	60.3%
DSL	99.3%	96.8%	93.1%	89.0%	84.6%	79.9%	74.9%	69.5%	63.6%
DSL/seal	98.1%	95.7%	91.6%	87.3%	82.6%	77.7%	72.3%	66.6%	60.3%
EnDat2.2	92.3%	89.1%	84.8%	80.2%	75.2%	69.9%	64.1%	57.7%	50.5%
EnDat2.2/Seal	91.1%	87.7%	83.2%	78.4%	73.1%	67.4%	61.2%	54.3%	

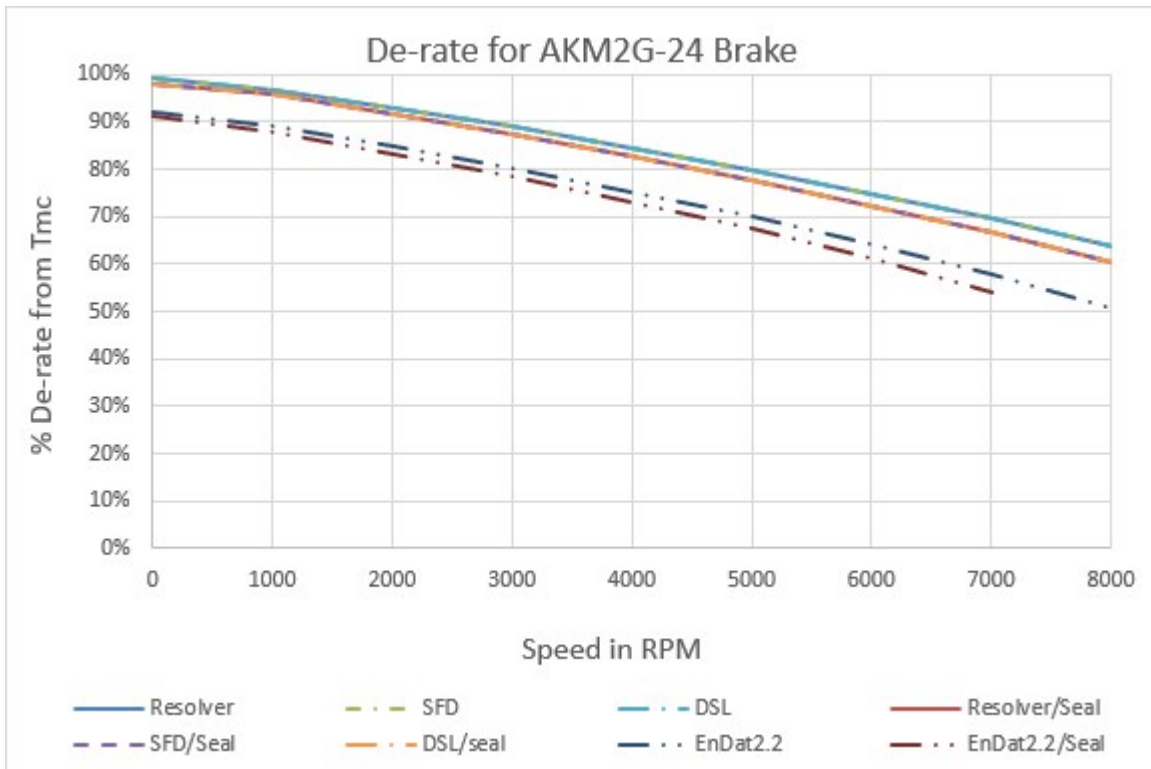

Note: For EnDat feedback motors acceleration of the motor is limited to $\leq 1 \cdot 10^5$ rad/s². The connected servo drive may further limit this value.

7.2.8 Technical Data AKM2G-24L

UN	Parameter	Tolerance	Symbol	Units	AKM2G		
					KL	ML	PL
Electrical data							
	Max. Rated DC Bus Voltage	Max	V bus	V dc	170	170	170
	Max. Continuous Torque for ΔT winding = 100°C (1)(2)(4)	Nom	Tmc	Nm	1.79	1.79	1.82
				lb-in	15.9	15.9	16.1
	Max. Continuous Current for ΔT winding = 100°C (1)(2)(4)	Nom	Imc	Arms	9.92	13.7	19.1
	Max. Continuous Torque for ΔT winding = 60°C (2)(4)	Nom	Tmc	Nm	1.39	1.39	1.41
				lb-in	12.3	12.3	12.5
	Max. mechanical speed (5)	Nom	Nmax	rpm	8000	8000	8000
	Peak Torque (1)(2)(4)	Nom	Tp	Nm	5.92	5.92	5.97
lb-in				52.4	52.3	52.8	
Peak Current	Nom	Ip	Arms	39.7	54.9	76.4	
24 V DC	Rated Torque (speed) (1)(2)(4)		Trtd	Nm			1.77
				lb-in			15.7
	Rated Speed		Nrtd	rpm			1600
	Rated Power (speed) (1)(2)(4)		Prtd	kW			0.297
Hp						0.399	
48 V DC	Rated Torque (speed) (1)(2)(4)		Trtd	Nm	1.73	1.69	1.65
				lb-in	15.3	15.0	14.6
	Rated Speed		Nrtd	rpm	2000	2900	4000
	Rated Power (speed) (1)(2)(4)		Prtd	kW	0.363	0.514	0.692
Hp				0.487	0.689	0.928	
72 V DC	Rated Torque (speed) (1)(2)(4)		Trtd	Nm	1.67	1.58	1.46
				lb-in	14.8	14.0	12.9
	Rated Speed		Nrtd	rpm	3300	4700	6500
	Rated Power (speed) (1)(2)(4)		Prtd	kW	0.578	0.779	0.994
Hp				0.775	1.05	1.33	
96 V DC	Rated Torque (speed) (1)(2)(4)		Trtd	Nm	1.59	1.44	1.30
				lb-in	14.1	12.8	11.5
	Rated Speed		Nrtd	rpm	4600	6500	8000
	Rated Power (speed) (1)(2)(4)		Prtd	kW	0.766	0.982	1.085
Hp				1.03	1.32	1.46	

UN	Parameter	Tolerance	Symbol	Units	AKM2G		
					KL	ML	PL
	Torque Constant (1)	+/- 10%	Kt	Nm/Arms	0.183	0.132	0.0962
				lb-in/Arms	1.62	1.169	0.852
	Back EMF Constant (6)	+/- 10%	Ke	Vrms/krpm	11.81	8.52	6.21
	Motor Constant (1)	Nom	Km	Nm/ \sqrt{W}	0.223	0.224	0.227
				lb-in/ \sqrt{W}	1.98	1.98	2.01
	Resistance (line-line) (6)	+/- 10%	Rm	Ω	0.448	0.233	0.120
	Inductance Q-Axis (line-line)		Lqll	mH	1.28	0.66	0.35
	Inductance D-Axis (line-line)		Ldll	mH	TBD	TBD	TBD
	Inductance Saturation Current		Lisat	Arms	99	137	188
	Maximum Demagnetization Current		Midpeak	Arms	TBD	TBD	TBD

Parameter	Symbol	Units	AKM2G		
			KL	ML	PL
Mechanical Data					
Inertia (incl. Resolver feedback) (3)	Jm	kgcm ²	0.279		
		lb-in-s ²	2.47E-04		
Optional Brake Inertia (additional)	Jm	kgcm ²	0.040		
		lb-in-s ²	3.54E-05		
Weight (8)	W	kg	2.0		
		lb	4.4		
Static Friction (1)	Tf	Nm	0.019		
		lb-in	0.17		
Viscous Damping (1)	Kdv	Nm/krpm	0.0060		
		lb-in/krpm	0.053		
Thermal Time Constant	TCT	mins.	13.0		
Thermal Resistance	Rthw-a	°C/W	1.04		
Pole Pairs	PP		3		
Heatsink Size			10" x 10" x 1/4" Aluminum Plate		

1. Motor winding at temp. rise, $\delta T = 100^{\circ}\text{C}$, at 40°C ambient
2. All data referenced to sinusoidal commutation
3. Add parking brake if applicable for total inertia
4. Motor with resolver feedback and standard heat sink
5. May be limited at some values of V_{bus}
6. Measured at 25°C
7. See de-rate chart for the de-rate of different motor options.
8. Brake motor adds 0.45 kg [1.0 lbs]
9. Shaft seal increases Static Friction by 0.020 Nm [0.21 lb-in]

Brake options are listed in chapter "Technical Data Brakes" from [Technical Data Brakes](#).

7.2.8.1 AKM2G-24L Derates for Different Options

Note: Derate information is for general estimation only. For the most accurate information for your motor use the online Performance Curve Generator located at pcgh.kollmorgen.com, the AKM2G Performance Curves document available for download at www.kollmorgen.com/sites/default/files/public_downloads/AKM2G%20Performance%20Curves_0.pdf, or refer to Kollmorgen's Motioneering Software Tool at www.kollmorgen.com/en-us/service-and-support/technical/motioneering-online/.

De-rates are referenced to the Max Continuous Torque ΔT wdg. = 100°C

Options - No Brake	Speed: RPM								
	0	1000	2000	3000	4000	5000	6000	7000	8000
SFD	100.0%	97.9%	95.2%	92.4%	89.4%	85.8%	81.7%	77.3%	72.6%
SFD/Seal	98.9%	96.8%	94.0%	91.1%	87.7%	83.6%	79.3%	74.6%	69.6%
DSL	100.0%	97.9%	95.2%	92.1%	88.5%	84.6%	80.4%	76.0%	71.3%
DSL/seal	98.9%	96.8%	94.0%	90.5%	86.6%	82.5%	78.0%	73.3%	68.2%
EnDat2.2	94.5%	91.9%	88.3%	84.6%	80.5%	76.2%	71.5%	66.5%	61.0%
EnDat2.2/Seal	93.4%	90.5%	86.8%	82.8%	78.5%	73.9%	68.9%	63.4%	

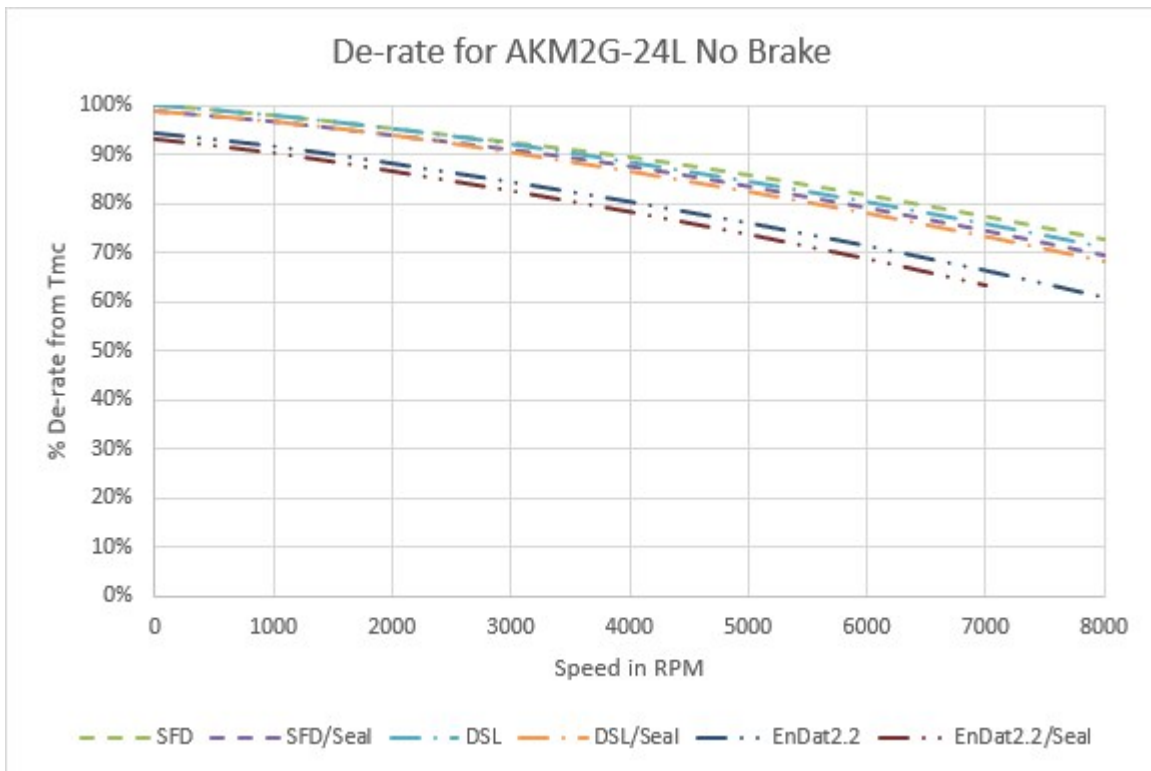

De-rates are referenced to the Max Continuous Torque ΔT wdg. = 100°C

Options - Brake	Speed: RPM								
	0	1000	2000	3000	4000	5000	6000	7000	8000
SFD	99.3%	97.2%	94.2%	90.7%	86.9%	83.0%	78.7%	74.2%	69.4%
SFD/Seal	98.1%	96.0%	92.7%	89.0%	85.0%	80.8%	76.3%	71.5%	66.2%
DSL	99.3%	97.2%	94.2%	90.7%	86.9%	83.0%	78.7%	74.2%	69.4%
DSL/seal	98.1%	96.0%	92.7%	89.0%	85.0%	80.8%	76.3%	71.5%	66.2%
EnDat2.2	92.4%	89.7%	86.1%	82.2%	78.0%	73.6%	68.8%	63.6%	57.8%
EnDat2.2/Seal	91.2%	88.3%	84.5%	80.4%	76.0%	71.2%	66.0%	60.4%	

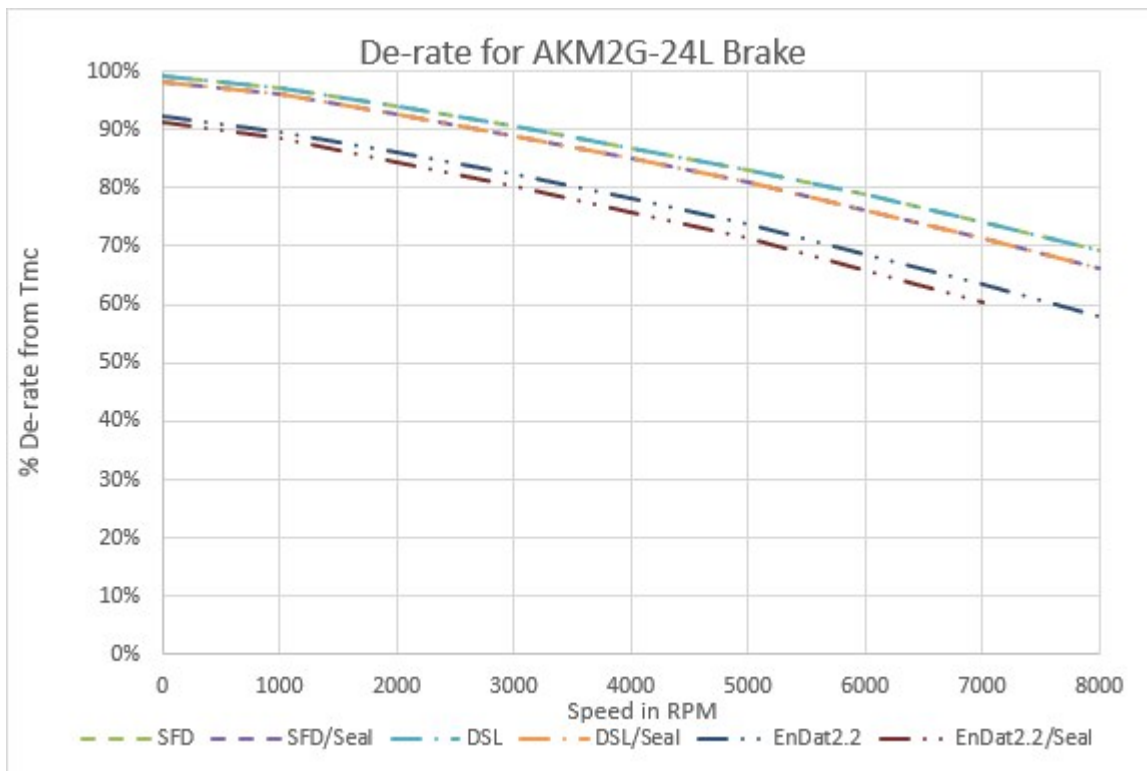

Note: For EnDat feedback motors acceleration of the motor is limited to $\leq 1 \cdot 10^5$ rad/s². The connected servo drive may further limit this value.

7.3 Technical Data AKM2G-3x Series

7.3.1 Technical Data AKM2G-31

UN	Parameter	Tolerance	Symbol	Units	AKM2G		
					31C	31D	31E
Electrical data							
	Max. Rated Equivalent Line Voltage	Max	V bus	V ac	480	480	480
	Max. Continuous Torque for ΔT winding = 100°C (1)(2)(4)	Nom	Tmc	Nm	1.68	1.68	1.70
				lb-in	14.9	14.9	15.1
	Max. Continuous Current for ΔT winding = 100°C (1)(2)(4)	Nom	Imc	Arms	1.48	2.06	2.90
	Max. Continuous Torque for ΔT winding = 60°C (2)(4)	Nom	Tmc	Nm	1.30	1.31	1.33
				lb-in	11.5	11.6	11.7
	Max. mechanical speed (5)	Nom	Nmax	rpm	8000	8000	8000
	Peak Torque (1)(2)(4)	Nom	Tp	Nm	5.99	6.00	6.06
				lb-in	53.0	53.1	53.6
	Peak Current	Nom	Ip	Arms	5.90	8.23	11.6
120 V AC	Rated Torque (speed) (1)(2)(4)		Trtd	Nm	1.67	1.67	1.68
				lb-in	14.8	14.8	14.8
	Rated Speed		Nrtd	rpm	1000	1500	2300
	Rated Power (speed) (1)(2)(4)		Prtd	kW	0.175	0.263	0.404
Hp				0.235	0.352	0.542	
240 V AC	Rated Torque (speed) (1)(2)(4)		Trtd	Nm	1.64	1.62	1.59
				lb-in	14.5	14.3	14.1
	Rated Speed		Nrtd	rpm	2400	3500	5000
	Rated Power (speed) (1)(2)(4)		Prtd	kW	0.412	0.594	0.832
Hp				0.553	0.796	1.12	
400 V AC	Rated Torque (speed) (1)(2)(4)		Trtd	Nm	1.58	1.52	1.43
				lb-in	14.0	13.5	12.7
	Rated Speed		Nrtd	rpm	4300	6100	8000
	Rated Power (speed) (1)(2)(4)		Prtd	kW	0.713	0.972	1.20
Hp				0.956	1.30	1.61	
480 V AC	Rated Torque (speed) (1)(2)(4)		Trtd	Nm	1.55	1.46	1.39
				lb-in	13.7	12.9	12.3
	Rated Speed		Nrtd	rpm	5200	7300	8000
	Rated Power (speed) (1)(2)(4)		Prtd	kW	0.844	1.12	1.16
Hp				1.13	1.50	1.56	

UN	Parameter	Tolerance	Symbol	Units	AKM2G		
					31C	31D	31E
	Torque Constant (1)	+/- 10%	Kt	Nm/Arms	1.16	0.836	0.601
				lb-in/Arms	10.3	7.399	5.318
	Back EMF Constant (6)	+/- 10%	Ke	Vrms/krpm	75.6	54.4	39.1
	Motor Constant (1)	Nom	Km	Nm/ \sqrt{W}	0.205	0.206	0.209
				lb-in/ \sqrt{W}	1.82	1.83	1.85
	Resistance (line-line) (6)	+/- 10%	Rm	Ω	21.4	10.9	5.49
	Inductance Q-Axis (line-line)		Lqll	mH	46.9	24.2	12.5
	Inductance D-Axis (line-line)		Ldll	mH	TBD	TBD	TBD
	Inductance Saturation Current		Lisat	Arms	20	28	39
	Maximum Demagnetization Current		Midpeak	Arms	TBD	TBD	TBD

Parameter	Symbol	Units	AKM2G		
			31C	31D	31E
Mechanical Data					
Inertia (incl. Resolver feedback) (3)	Jm	kgcm ²	0.426		
		lb-in-s ²	3.77E-04		
Optional Brake Inertia (additional)	Jm	kgcm ²	0.120		
		lb-in-s ²	1.06E-04		
Weight (8)	W	kg	1.8		
		lb	4.0		
Static Friction (1)	Tf	Nm	0.013		
		lb-in	0.12		
Viscous Damping (1)	Kdv	Nm/krpm	0.0039		
		lb-in/krpm	0.035		
Thermal Time Constant	TCT	mins.	17		
Thermal Resistance	Rthw-a	°C/W	0.980		
Pole Pairs	PP		4		
Heatsink Size			10" x 10" x 1/4" Aluminum Plate		

1. Motor winding at temp. rise, $\delta T = 100^{\circ}\text{C}$, at 40°C ambient
2. All data referenced to sinusoidal commutation
3. Add parking brake if applicable for total inertia
4. Motor with resolver feedback and standard heat sink
5. May be limited at some values of V_{bus}
6. Measured at 25°C
7. See de-rate chart for the de-rate of different motor options.
8. Brake motor adds 0.72 kg [1.6 lbs]
9. Shaft seal increases Static Friction by 0.017 Nm [0.15 lb-in]

Brake options are listed in chapter "Technical Data Brakes" from [Technical Data Brakes](#).

7.3.1.1 AKM2G-31 Derates for Different Options

Note: Derate information is for general estimation only. For the most accurate information for your motor use the online Performance Curve Generator located at pcgh.kollmorgen.com, the AKM2G Performance Curves document available for download at www.kollmorgen.com/sites/default/files/public_downloads/AKM2G%20Performance%20Curves_0.pdf, or refer to Kollmorgen's Motioneering Software Tool at www.kollmorgen.com/en-us/service-and-support/technical/motioneering-online/.

De-rates are referenced to the Max Continuous Torque ΔT wdg. = 100°C

Options - No Brake	Speed: RPM								
	0	1000	2000	3000	4000	5000	6000	7000	8000
Resolver	100.0%	98.2%	95.9%	93.6%	91.3%	88.9%	86.5%	84.1%	81.6%
Resolver/Seal	99.5%	97.6%	95.2%	92.7%	90.2%	87.6%	85.0%	82.4%	79.7%
SFD	100.0%	98.2%	95.9%	93.6%	91.1%	87.9%	84.6%	81.3%	78.0%
SFD/Seal	99.5%	97.6%	95.2%	92.7%	90.0%	86.5%	83.0%	79.4%	75.8%
DSL	100.0%	98.2%	95.5%	92.1%	88.8%	85.4%	81.9%	78.5%	75.0%
DSL/Seal	99.5%	97.6%	94.7%	91.1%	87.5%	83.9%	80.2%	76.5%	72.7%
EnDat2.2	98.8%	96.1%	92.6%	89.1%	85.6%	82.0%	78.4%	74.7%	71.0%
EnDat2.2/Seal	98.3%	95.4%	91.8%	88.1%	84.3%	80.5%	76.6%	72.6%	68.6%

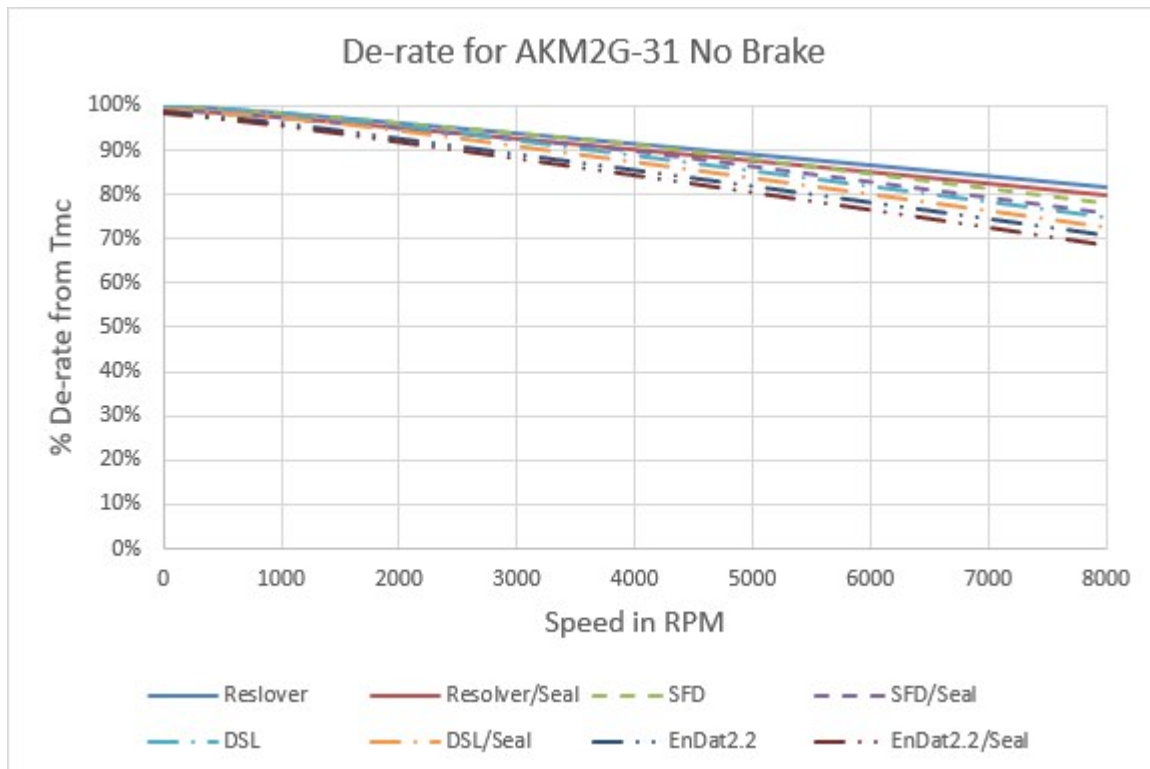

De-rates are referenced to the Max Continuous Torque ΔT wdg. = 100°C

Options - Brake	Speed: RPM								
	0	1000	2000	3000	4000	5000	6000	7000	8000
Resolver	99.3%	97.5%	95.2%	92.9%	90.5%	88.2%	85.7%	83.0%	79.8%
Resolver/Seal	98.8%	96.9%	94.4%	92.0%	89.4%	86.9%	84.2%	81.1%	77.7%
SFD	99.3%	97.5%	95.2%	92.6%	89.3%	85.9%	82.5%	79.1%	75.6%
SFD/Seal	98.8%	96.9%	94.4%	91.6%	88.0%	84.4%	80.8%	77.1%	73.4%
DSL	99.3%	96.8%	93.4%	89.9%	86.4%	82.8%	79.3%	75.7%	72.0%
DSL/Seal	98.8%	96.1%	92.5%	88.8%	85.1%	81.3%	77.5%	73.6%	69.7%
EnDat2.2	95.0%	92.2%	88.5%	84.7%	80.9%	77.0%	73.1%	69.1%	65.1%
EnDat2.2/Seal	94.5%	91.5%	87.6%	83.6%	79.5%	75.4%	71.2%	66.9%	62.5%

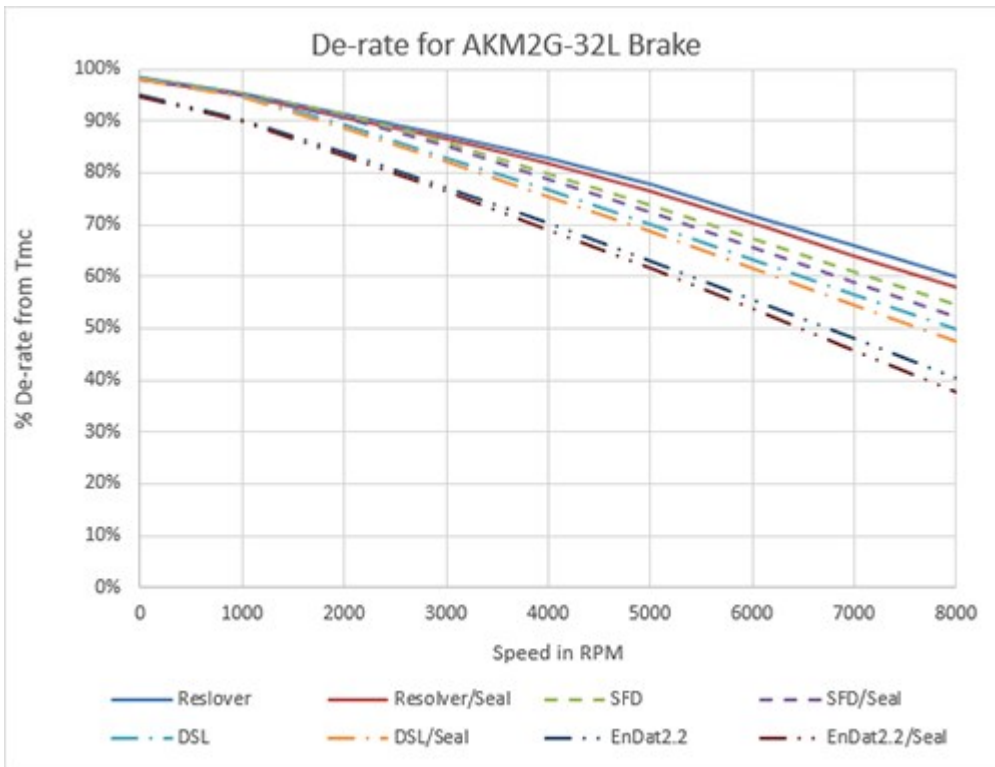

Note: For EnDat feedback motors acceleration of the motor is limited to $\leq 1 \cdot 10^5$ rad/s². The connected servo drive may further limit this value.

7.3.2 Technical Data AKM2G-31L

UN	Parameter	Tolerance	Symbol	Units	AKM2G	
					ML	PL
Electrical data						
	Max. Rated DC Bus Voltage	Max	V bus	V dc	170	170
	Max. Continuous Torque for ΔT winding = 100°C (1)(2)(4)	Nom	Tmc	Nm	1.73	1.69
				lb-in	15.3	15.0
	Max. Continuous Current for ΔT winding = 100°C (1)(2)(4)	Nom	Imc	Arms	14.2	20.0
	Max. Continuous Torque for ΔT winding = 60°C (2)(4)	Nom	Tmc	Nm	1.34	1.33
				lb-in	11.9	11.8
	Max. mechanical speed (5)	Nom	Nmax	rpm	8000	8000
	Peak Torque (1)(2)(4)	Nom	Tp	Nm	6.14	6.09
lb-in				54.3	53.9	
Peak Current	Nom	Ip	Arms	56.8	80.7	
24 V DC	Rated Torque (speed) (1)(2)(4)		Trtd	Nm		1.67
				lb-in		14.8
	Rated Speed		Nrtd	rpm		2200
	Rated Power (speed) (1)(2)(4)		Prtd	kW		0.385
Hp					0.517	
48 V DC	Rated Torque (speed) (1)(2)(4)		Trtd	Nm	1.65	1.57
				lb-in	14.6	13.9
	Rated Speed		Nrtd	rpm	3300	4900
	Rated Power (speed) (1)(2)(4)		Prtd	kW	0.570	0.804
Hp				0.764	1.08	
72 V DC	Rated Torque (speed) (1)(2)(4)		Trtd	Nm	1.57	1.41
				lb-in	13.9	12.4
	Rated Speed		Nrtd	rpm	5200	7800
	Rated Power (speed) (1)(2)(4)		Prtd	kW	0.853	1.15
Hp				1.14	1.54	
96 V DC	Rated Torque (speed) (1)(2)(4)		Trtd	Nm	1.46	
				lb-in	12.9	
	Rated Speed		Nrtd	rpm	7200	
	Rated Power (speed) (1)(2)(4)		Prtd	kW	1.10	
Hp				1.47		

UN	Parameter	Tolerance	Symbol	Units	AKM2G	
					ML	PL
	Torque Constant (1)	+/- 10%	Kt	Nm/Arms	0.124	0.087
				lb-in/Arms	1.10	0.766
	Back EMF Constant (6)	+/- 10%	Ke	Vrms/krpm	8.09	5.64
	Motor Constant (1)	Nom	Km	Nm/ \sqrt{W}	0.211	0.210
				lb-in/ \sqrt{W}	1.87	1.85
	Resistance (line-line) (6)	+/- 10%	Rm	Ω	0.230	0.114
	Inductance Q-Axis (line-line)		Lqll	mH	0.54	0.26
	Inductance D-Axis (line-line)		Ldll	mH	TBD	TBD
	Inductance Saturation Current		Lisat	Arms	188	270
Maximum Demagnetization Current		Midpeak	Arms	TBD	TBD	

Parameter	Symbol	Units	AKM2G		
			ML	PL	QL
Mechanical Data					
Inertia (incl. Resolver feedback) (3)	Jm	kgcm ²	0.426		
		lb-in-s ²	3.77E-04		
Optional Brake Inertia (additional)	Jm	kgcm ²	0.120		
		lb-in-s ²	1.06E-04		
Weight (8)	W	kg	1.8		
		lb	4.0		
Static Friction (1)	Tf	Nm	0.013		
		lb-in	0.12		
Viscous Damping (1)	Kdv	Nm/krpm	0.0039		
		lb-in/krpm	0.035		
Thermal Time Constant	TCT	mins.	17		
Thermal Resistance	Rthw-a	°C/W	0.980		
Pole Pairs	PP		4		
Heatsink Size			10" x 10" x 1/4" Aluminum Plate		

1. Motor winding at temp. rise, $\delta T = 100^{\circ}\text{C}$, at 40°C ambient
2. All data referenced to sinusoidal commutation
3. Add parking brake if applicable for total inertia
4. Motor with resolver feedback and standard heat sink
5. May be limited at some values of V_{bus}
6. Measured at 25°C
7. See de-rate chart for the de-rate of different motor options.
8. Brake motor adds 0.72 kg [1.6 lbs]
9. Shaft seal increases Static Friction by 0.017 Nm [0.15 lb-in]

Brake options are listed in chapter "Technical Data Brakes" from [Technical Data Brakes](#).

7.3.2.1 AKM2G-31L Derates for Different Options

Note: Derate information is for general estimation only. For the most accurate information for your motor use the online Performance Curve Generator located at pcgh.kollmorgen.com, the AKM2G Performance Curves document available for download at www.kollmorgen.com/sites/default/files/public_downloads/AKM2G%20Performance%20Curves_0.pdf, or refer to Kollmorgen's Motioneering Software Tool at www.kollmorgen.com/en-us/service-and-support/technical/motioneering-online/.

De-rates are referenced to the Max Continuous Torque ΔT wdg. = 100°C

Options - No Brake	Speed: RPM								
	0	1000	2000	3000	4000	5000	6000	7000	8000
Resolver	100.0%	98.2%	95.8%	93.3%	90.8%	88.1%	85.3%	82.5%	79.5%
Resolver/Seal	99.5%	97.6%	95.0%	92.4%	89.7%	86.8%	83.9%	80.8%	77.7%
SFD	100.0%	98.2%	95.8%	93.3%	90.8%	87.3%	83.6%	79.9%	76.1%
SFD/Seal	99.5%	97.6%	95.0%	92.4%	89.6%	85.9%	82.0%	78.0%	74.0%
DSL	100.0%	98.2%	95.5%	92.0%	88.5%	84.8%	81.0%	77.1%	73.2%
DSL/Seal	99.5%	97.6%	94.7%	91.0%	87.3%	83.4%	79.3%	75.2%	71.0%
EnDat2.2	98.9%	96.2%	92.7%	89.1%	85.3%	81.5%	77.5%	73.4%	69.3%
EnDat2.2/Seal	98.4%	95.5%	91.9%	88.0%	84.1%	80.0%	75.7%	71.4%	66.9%

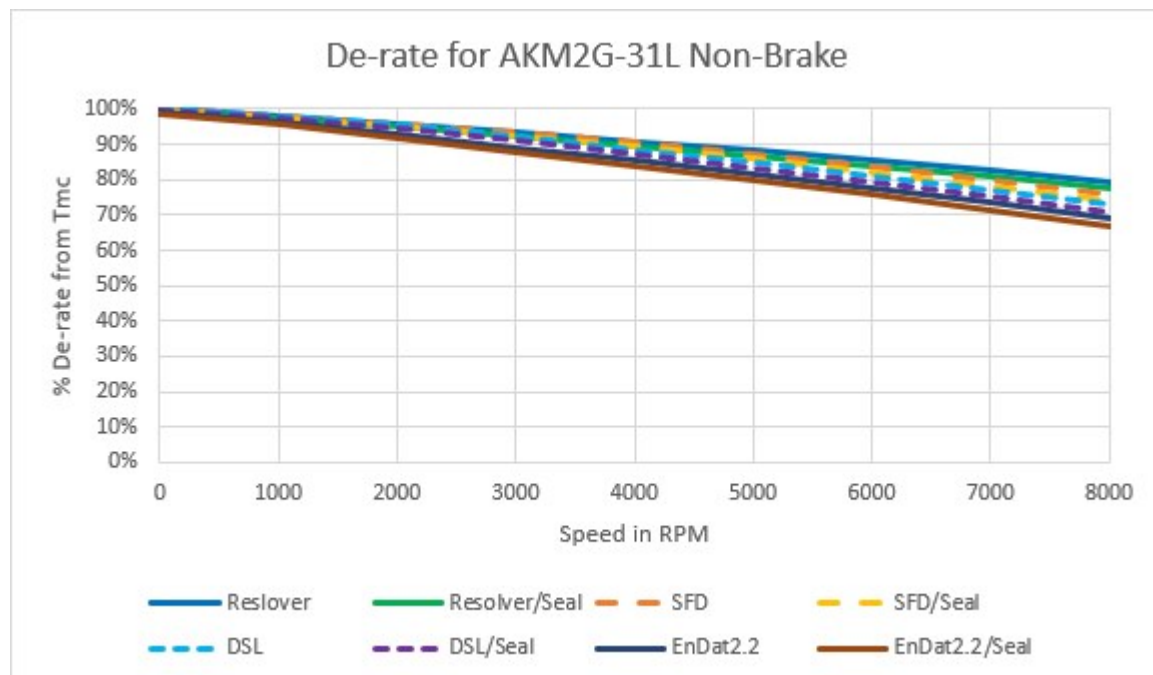

De-rates are referenced to the Max Continuous Torque ΔT wdg. = 100°C

Options - Brake	Speed: RPM								
	0	1000	2000	3000	4000	5000	6000	7000	8000
Resolver	99.3%	97.5%	95.1%	92.6%	90.0%	87.3%	84.5%	81.6%	77.8%
Resolver/Seal	98.8%	96.8%	94.3%	91.7%	88.9%	86.0%	83.1%	79.7%	75.8%
SFD	99.3%	97.5%	95.1%	92.5%	89.0%	85.3%	81.5%	77.7%	73.8%
SFD/Seal	98.8%	96.8%	94.3%	91.5%	87.8%	83.9%	79.9%	75.8%	71.6%
DSL	99.3%	96.9%	93.4%	89.8%	86.1%	82.3%	78.4%	74.4%	70.3%
DSL/Seal	98.8%	96.2%	92.6%	88.8%	84.9%	80.8%	76.7%	72.4%	68.0%
EnDat2.2	95.1%	92.3%	88.5%	84.7%	80.7%	76.6%	72.3%	68.0%	63.5%
EnDat2.2/Seal	94.6%	91.6%	87.7%	83.6%	79.4%	75.0%	70.5%	65.8%	61.1%

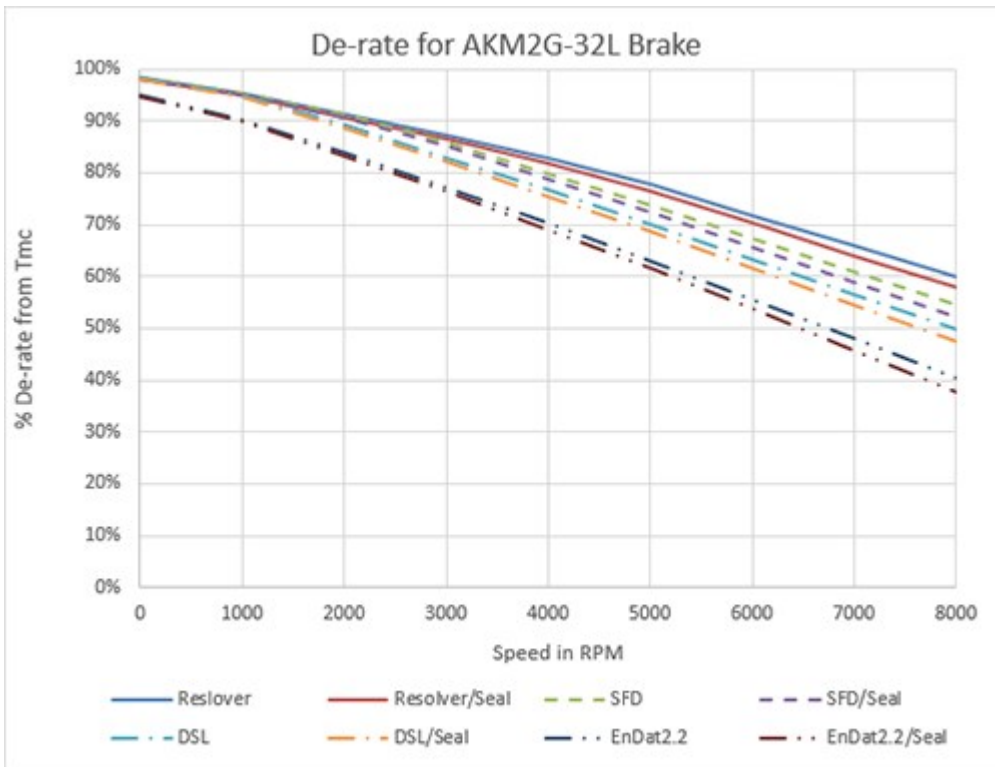

Note: For EnDat feedback motors acceleration of the motor is limited to $\leq 1 \cdot 10^5$ rad/s². The connected servo drive may further limit this value.

7.3.3 Technical Data AKM2G-32

UN	Parameter	Tolerance	Symbol	Units	AKM2G		
					32D	32E	32G
Electrical data							
	Max. Rated Equivalent Line Voltage	Max	V bus	V ac	480	480	400
	Max. Continuous Torque for ΔT winding = 100°C (1)(2)(4)	Nom	Tmc	Nm	2.81	2.80	2.90
				lb-in	24.8	24.8	25.7
	Max. Continuous Current for ΔT winding = 100°C (1)(2)(4)	Nom	Imc	Arms	2.17	2.75	4.24
	Max. Continuous Torque for ΔT winding = 60°C (2)(4)	Nom	Tmc	Nm	2.18	2.18	2.26
				lb-in	19.3	19.3	20.0
	Max. mechanical speed (5)	Nom	Nmax	rpm	8000	8000	8000
	Peak Torque (1)(2)(4)	Nom	Tp	Nm	10.4	10.3	10.6
lb-in				91.7	91.6	94.2	
Peak Current	Nom	Ip	Arms	8.66	11.0	17.0	
120 V AC	Rated Torque (speed) (1)(2)(4)		Trtd	Nm		2.78	2.82
				lb-in		24.6	25.0
	Rated Speed		Nrtd	rpm		1300	2300
	Rated Power (speed) (1)(2)(4)		Prtd	kW		0.378	0.680
Hp					0.507	0.912	
240 V AC	Rated Torque (speed) (1)(2)(4)		Trtd	Nm	2.72	2.67	2.60
				lb-in	24.1	23.6	23.0
	Rated Speed		Nrtd	rpm	2200	2900	4700
	Rated Power (speed) (1)(2)(4)		Prtd	kW	0.628	0.811	1.28
Hp				0.842	1.09	1.72	
400 V AC	Rated Torque (speed) (1)(2)(4)		Trtd	Nm	2.58	2.46	2.17
				lb-in	22.9	21.8	19.2
	Rated Speed		Nrtd	rpm	3900	5000	7600
	Rated Power (speed) (1)(2)(4)		Prtd	kW	1.06	1.29	1.72
Hp				1.42	1.73	2.31	
480 V AC	Rated Torque (speed) (1)(2)(4)		Trtd	Nm	2.50	2.33	
				lb-in	22.1	20.6	
	Rated Speed		Nrtd	rpm	4700	6100	
	Rated Power (speed) (1)(2)(4)		Prtd	kW	1.23	1.49	
Hp				1.65	1.99		

UN	Parameter	Tolerance	Symbol	Units	AKM2G		
					32D	32E	32G
	Torque Constant (1)	+/- 10%	Kt	Nm/Arms	1.33	1.05	0.701
				lb-in/Arms	11.8	9.26	6.20
	Back EMF Constant (6)	+/- 10%	Ke	Vrms/krpm	86.1	67.7	45.4
	Motor Constant (1)	Nom	Km	Nm/ \sqrt{W}	0.326	0.325	0.337
				lb-in/ \sqrt{W}	2.88	2.88	2.99
	Resistance (line-line) (6)	+/- 10%	Rm	Ω	11.14	6.90	2.87
	Inductance Q-Axis (line-line)		Lqll	mH	24.7	15.3	6.8
	Inductance D-Axis (line-line)		Ldll	mH	TBD	TBD	TBD
	Inductance Saturation Current		Lisat	Arms	36	46	68
	Maximum Demagnetization Current		Midpeak	Arms	TBD	TBD	TBD

Parameter	Symbol	Units	AKM2G		
			32D	32E	32G
Mechanical Data					
Inertia (incl. Resolver feedback) (3)	Jm	kgcm ²	0.813		
		lb-in-s ²	7.20E-04		
Optional Brake Inertia (additional)	Jm	kgcm ²	0.120		
		lb-in-s ²	1.06E-04		
Weight (8)	W	kg	2.5		
		lb	5.6		
Static Friction (1)	Tf	Nm	0.023		
		lb-in	0.20		
Viscous Damping (1)	Kdv	Nm/krpm	0.0078		
		lb-in/krpm	0.069		
Thermal Time Constant	TCT	mins.	21		
Thermal Resistance	Rthw-a	°C/W	0.868		
Pole Pairs	PP		4		
Heatsink Size			10" x 10" x 1/4" Aluminum Plate		

1. Motor winding at temp. rise, $\delta T = 100^{\circ}\text{C}$, at 40°C ambient
2. All data referenced to sinusoidal commutation
3. Add parking brake if applicable for total inertia
4. Motor with resolver feedback and standard heat sink
5. May be limited at some values of V_{bus}
6. Measured at 25°C
7. See de-rate chart for the de-rate of different motor options.
8. Brake motor adds 0.45 kg [1.0 lbs]
9. Shaft seal increases Static Friction by 0.020 Nm [0.21 lb-in]

Brake options are listed in chapter "Technical Data Brakes" from [Technical Data Brakes](#).

7.3.3.1 AKM2G-32 Derates for Different Options

Note: Derate information is for general estimation only. For the most accurate information for your motor use the online Performance Curve Generator located at pcgh.kollmorgen.com, the AKM2G Performance Curves document available for download at www.kollmorgen.com/sites/default/files/public_downloads/AKM2G%20Performance%20Curves_0.pdf, or refer to Kollmorgen's Motioneering Software Tool at www.kollmorgen.com/en-us/service-and-support/technical/motioneering-online/.

De-rates are referenced to the Max Continuous Torque ΔT wdg. = 100°C

Options - No Brake	Speed: RPM								
	0	1000	2000	3000	4000	5000	6000	7000	8000
Resolver	100.0%	97.3%	93.9%	90.5%	87.0%	83.6%	80.1%	76.7%	74.6%
Resolver/Seal	99.7%	96.9%	93.3%	89.7%	86.1%	82.5%	78.9%	75.3%	73.1%
SFD	100.0%	97.3%	93.9%	90.5%	86.6%	81.9%	77.2%	72.7%	70.0%
SFD/Seal	99.7%	96.9%	93.3%	89.7%	85.6%	80.7%	75.8%	70.9%	68.1%
DSL	100.0%	97.3%	93.7%	88.8%	83.9%	79.0%	74.1%	69.3%	66.4%
DSL/Seal	99.7%	96.9%	93.1%	88.0%	82.9%	77.8%	72.6%	67.5%	64.4%
EnDat2.2	99.8%	95.8%	90.7%	85.6%	80.4%	75.1%	69.9%	64.7%	61.6%
EnDat2.2/Seal	99.5%	95.4%	90.1%	84.7%	79.3%	73.8%	68.3%	62.8%	59.5%

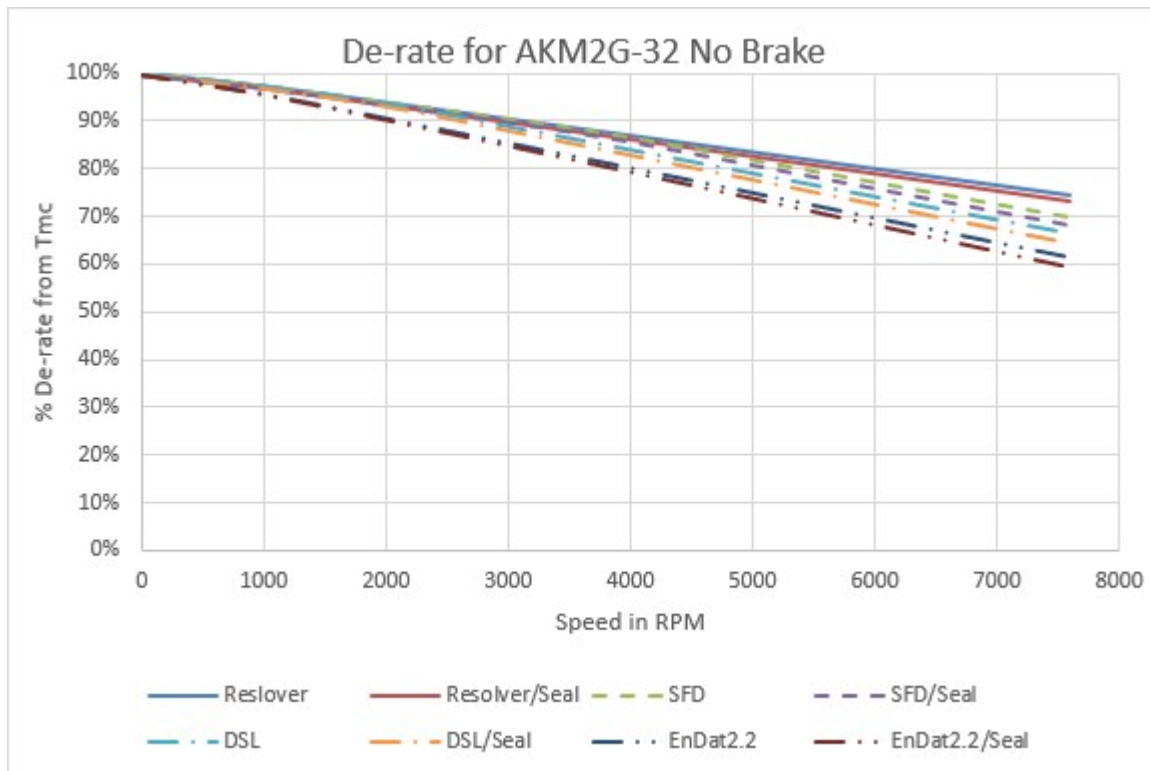

De-rates are referenced to the Max Continuous Torque ΔT wdg. = 100°C

Options - Brake	Speed: RPM								
	0	1000	2000	3000	4000	5000	6000	7000	8000
Resolver	97.0%	94.2%	90.7%	87.2%	83.7%	80.1%	75.7%	71.1%	68.4%
Resolver/Seal	96.7%	93.8%	90.2%	86.5%	82.8%	79.0%	74.3%	69.4%	66.5%
SFD	97.0%	94.2%	90.7%	86.5%	81.5%	76.5%	71.4%	66.5%	63.5%
SFD/Seal	96.7%	93.8%	90.2%	85.7%	80.5%	75.2%	69.9%	64.6%	61.5%
DSL	97.0%	94.0%	88.9%	83.6%	78.3%	73.0%	67.7%	62.4%	59.3%
DSL/Seal	96.7%	93.6%	88.2%	82.8%	77.3%	71.7%	66.1%	60.4%	57.1%
EnDat2.2	93.8%	89.4%	83.8%	78.1%	72.2%	66.3%	60.3%	54.3%	50.7%
EnDat2.2/Seal	93.5%	88.9%	83.1%	77.2%	71.1%	64.9%	58.5%	52.0%	48.1%

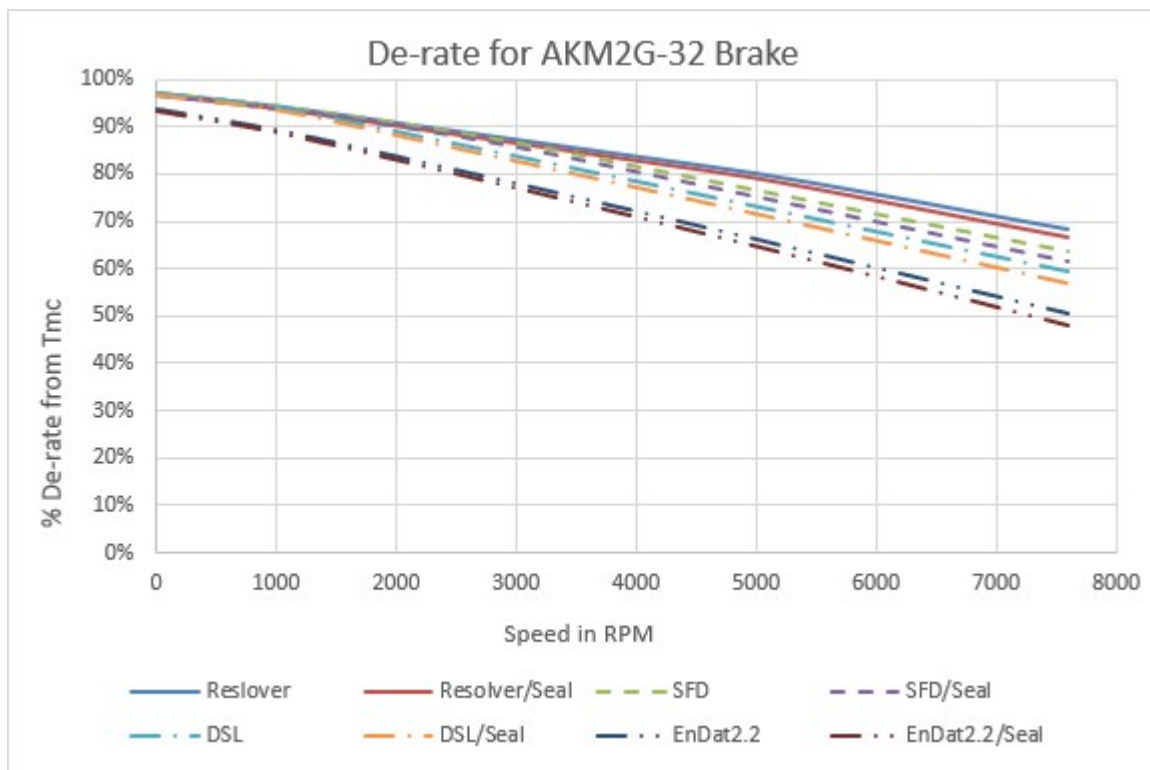

Note: For EnDat feedback motors acceleration of the motor is limited to $\leq 1 \cdot 10^5$ rad/s². The connected servo drive may further limit this value.

7.3.4 Technical Data AKM2G-32L

U _N	Parameter	Tolerance	Symbol	Units	AKM2G	
					ML	PL
Electrical data						
	Max. Rated DC Bus Voltage	Max	V bus	V dc	170	170
	Max. Continuous Torque for ΔT winding = 100°C (1)(2)(4)	Nom	Tmc	Nm	2.89	2.77
				lb-in	25.6	24.6
	Max. Continuous Current for ΔT winding = 100°C (1)(2)(4)	Nom	Imc	Arms	14.8	20.0
	Max. Continuous Torque for ΔT winding = 60°C (2)(4)	Nom	Tmc	Nm	2.25	2.23
				lb-in	19.9	19.7
	Max. mechanical speed (5)	Nom	Nmax	rpm	8000	8000
Peak Torque (1)(2)(4)	Nom	Tp	Nm	10.7	10.6	
			lb-in	94.6	93.7	
Peak Current	Nom	Ip	Arms	59.1	82.4	
24 V DC	Rated Torque (speed) (1)(2)(4)		Trtd	Nm		2.79
				lb-in		24.7
	Rated Speed		Nrtd	rpm		1300
	Rated Power (speed) (1)(2)(4)		Prtd	kW		0.379
Hp					0.509	
48 V DC	Rated Torque (speed) (1)(2)(4)		Trtd	Nm	2.81	2.70
				lb-in	24.9	23.9
	Rated Speed		Nrtd	rpm	2000	3000
	Rated Power (speed) (1)(2)(4)		Prtd	kW	0.589	0.849
Hp				0.790	1.138	
72 V DC	Rated Torque (speed) (1)(2)(4)		Trtd	Nm	2.70	2.51
				lb-in	23.9	22.2
	Rated Speed		Nrtd	rpm	3200	4700
	Rated Power (speed) (1)(2)(4)		Prtd	kW	0.906	1.23
Hp				1.215	1.66	
96 V DC	Rated Torque (speed) (1)(2)(4)		Trtd	Nm	2.57	2.26
				lb-in	22.7	20.0
	Rated Speed		Nrtd	rpm	4400	6400
	Rated Power (speed) (1)(2)(4)		Prtd	kW	1.18	1.51
Hp				1.59	2.03	

UN	Parameter	Tolerance	Symbol	Units	AKM2G	
					ML	PL
	Torque Constant (1)	+/- 10%	Kt	Nm/Arms	0.201	0.142
				lb-in/Arms	1.78	1.261
	Back EMF Constant (6)	+/- 10%	Ke	Vrms/krpm	13.09	9.28
	Motor Constant (1)	Nom	Km	Nm/√W	0.335	0.332
				lb-in/√W	2.97	2.94
	Resistance (line-line) (6)	+/- 10%	Rm	Ω	0.240	0.122
	Inductance Q-Axis (line-line)		Lqll	mH	0.57	0.29
	Inductance D-Axis (line-line)		Ldll	mH	TBD	TBD
	Inductance Saturation Current		Lisat	Arms	236	333
	Maximum Demagnetization Current		Midpeak	Arms	TBD	TBD

Parameter	Symbol	Units	AKM2G		
			ML	PL	QL
Mechanical Data					
Inertia (incl. Resolver feedback) (3)	Jm	kgcm ²	0.813		
		lb-in-s ²	7.20E-04		
Optional Brake Inertia (additional)	Jm	kgcm ²	0.120		
		lb-in-s ²	1.06E-04		
Weight (8)	W	kg	2.5		
		lb	5.6		
Static Friction (1)	Tf	Nm	0.023		
		lb-in	0.20		
Viscous Damping (1)	Kdv	Nm/krpm	0.0078		
		lb-in/krpm	0.069		
Thermal Time Constant	TCT	mins.	21		
Thermal Resistance	Rthw-a	°C/W	0.868		
Pole Pairs	PP		4		
Heatsink Size			10" x 10" x 1/4" Aluminum Plate		

1. Motor winding at temp. rise, $\delta T = 100^{\circ}\text{C}$, at 40°C ambient
2. All data referenced to sinusoidal commutation
3. Add parking brake if applicable for total inertia
4. Motor with resolver feedback and standard heat sink
5. May be limited at some values of V_{bus}
6. Measured at 25°C
7. See de-rate chart for the de-rate of different motor options.
8. Brake motor adds 0.45 kg [1.0 lbs]
9. Shaft seal increases Static Friction by 0.020 Nm [0.21 lb-in]

Brake options are listed in chapter "Technical Data Brakes" from [Technical Data Brakes](#).

7.3.4.1 AKM2G-32L Derates for Different Options

Note: Derate information is for general estimation only. For the most accurate information for your motor use the online Performance Curve Generator located at pcgh.kollmorgen.com, the AKM2G Performance Curves document available for download at www.kollmorgen.com/sites/default/files/public_downloads/AKM2G%20Performance%20Curves_0.pdf, or refer to Kollmorgen's Motioneering Software Tool at www.kollmorgen.com/en-us/service-and-support/technical/motioneering-online/.

De-rates are referenced to the Max Continuous Torque ΔT wdg. = 100°C

Options - No Brake	Speed: RPM								
	0	1000	2000	3000	4000	5000	6000	7000	8000
Resolver	100.0%	98.4%	94.5%	90.4%	86.3%	82.0%	77.7%	73.3%	68.8%
Resolver/Seal	99.7%	98.0%	93.9%	89.7%	85.4%	81.0%	76.5%	71.9%	67.2%
SFD	100.0%	98.4%	94.5%	90.4%	85.2%	79.3%	73.3%	67.3%	61.4%
SFD/Seal	99.7%	98.0%	93.9%	89.7%	84.2%	78.1%	71.9%	65.6%	59.3%
DSL	100.0%	98.4%	94.0%	88.3%	82.4%	76.3%	70.1%	63.8%	57.5%
DSL/Seal	99.7%	98.0%	93.4%	87.5%	81.4%	75.0%	68.5%	61.9%	55.3%
EnDat2.2	100.0%	96.7%	90.9%	84.9%	78.7%	72.2%	65.6%	58.9%	52.2%
EnDat2.2/Seal	99.7%	96.3%	90.3%	84.1%	77.6%	70.9%	63.9%	56.9%	49.9%

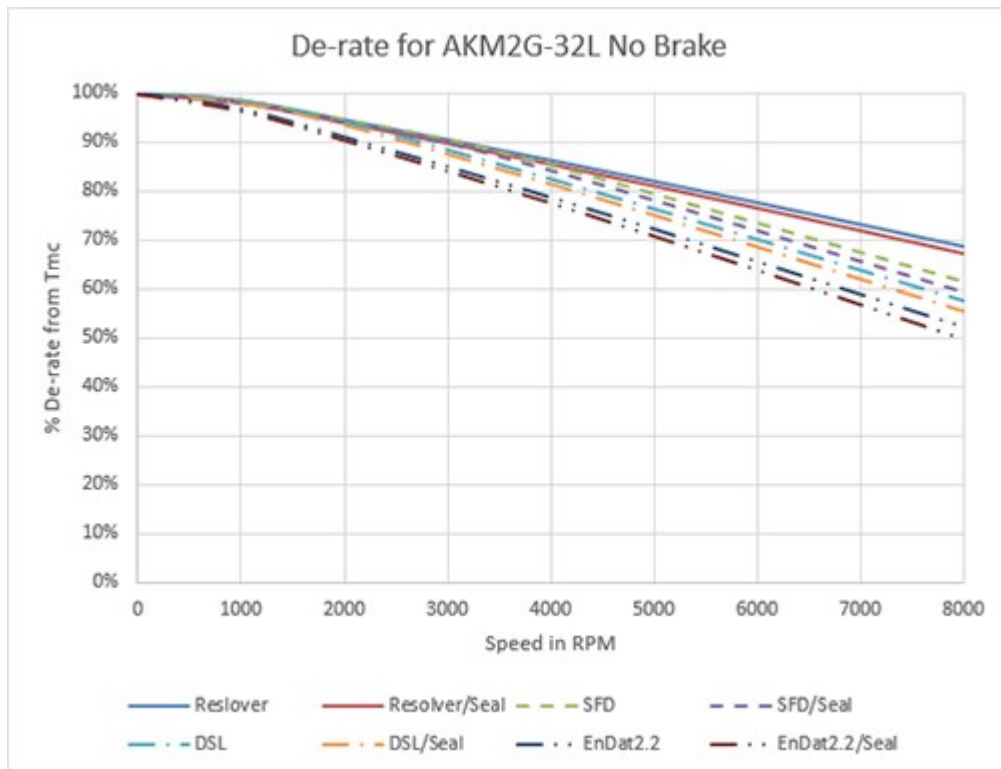

De-rates are referenced to the Max Continuous Torque ΔT wdg. = 100°C

Options - Brake	Speed: RPM								
	0	1000	2000	3000	4000	5000	6000	7000	8000
Resolver	98.4%	95.3%	91.3%	87.1%	82.9%	77.8%	71.8%	65.8%	59.8%
Resolver/Seal	98.1%	94.9%	90.7%	86.4%	82.0%	76.6%	70.3%	64.0%	57.8%
SFD	98.4%	95.3%	91.3%	85.9%	79.9%	73.7%	67.3%	60.9%	54.6%
SFD/Seal	98.1%	94.9%	90.7%	85.1%	78.9%	72.4%	65.7%	59.0%	52.3%
DSL	98.4%	94.9%	89.1%	83.0%	76.6%	70.1%	63.4%	56.6%	49.9%
DSL/Seal	98.1%	94.5%	88.4%	82.1%	75.5%	68.7%	61.7%	54.6%	47.4%
EnDat2.2	95.1%	90.2%	83.9%	77.2%	70.3%	63.1%	55.6%	48.0%	40.5%
EnDat2.2/Seal	94.8%	89.8%	83.2%	76.3%	69.1%	61.5%	53.7%	45.7%	37.6%

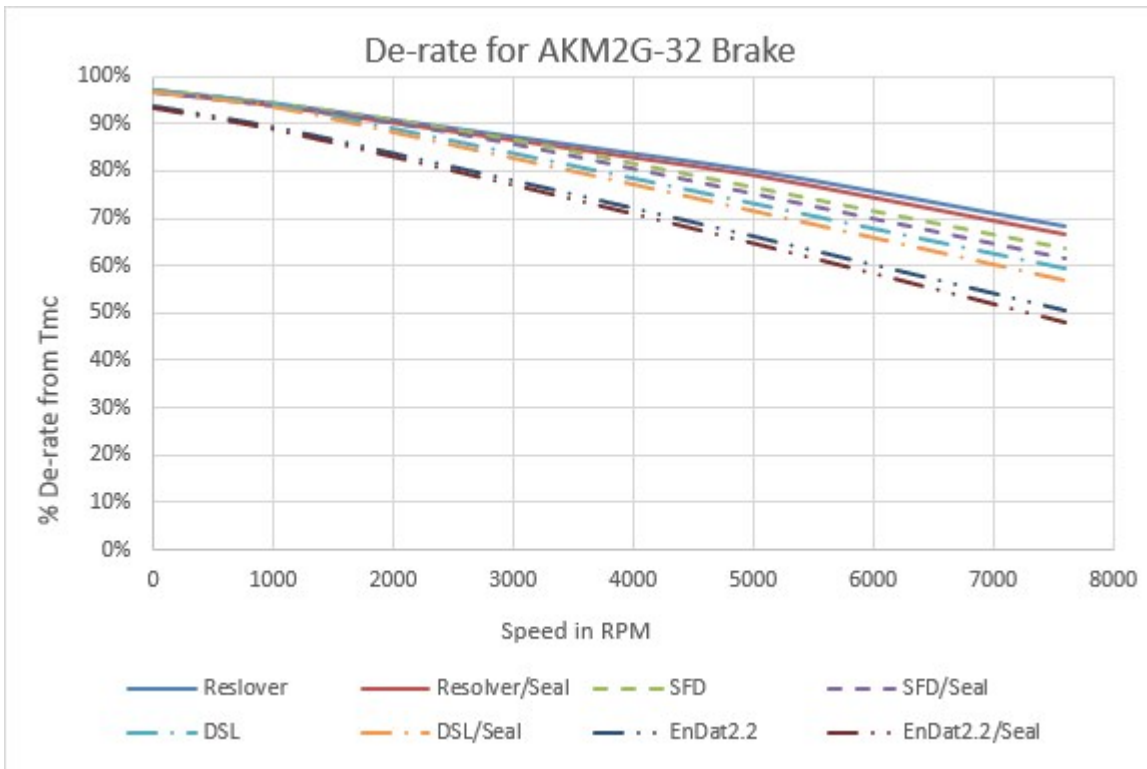

Note: For EnDat feedback motors acceleration of the motor is limited to $\leq 1 \cdot 10^5$ rad/s². The connected servo drive may further limit this value.

7.3.5 Technical Data AKM2G-33

UN	Parameter	Tolerance	Symbol	Units	AKM2G		
					33E	33G	33H
Electrical data							
	Max. Rated Equivalent Line Voltage	Max	V bus	V ac	480	480	400
	Max. Continuous Torque for ΔT winding = 100°C (1)(2)(4)	Nom	Tmc	Nm	3.86	3.81	3.85
				ib-in	34.1	33.7	34.1
	Max. Continuous Current for ΔT winding = 100°C (1)(2)(4)	Nom	Imc	Arms	2.99	4.24	5.80
	Max. Continuous Torque for ΔT winding = 60°C (2)(4)	Nom	Tmc	Nm	3.00	2.97	3.01
				lb-in	26.5	26.3	26.7
	Max. mechanical speed (5)	Nom	Nmax	rpm	8000	8000	8000
	Peak Torque (1)(2)(4)	Nom	Tp	Nm	14.6	14.4	14.6
				lb-in	129	128	129
	Peak Current	Nom	Ip	Arms	12.0	16.9	23.2
120 V AC	Rated Torque (speed) (1)(2)(4)		Trtd	Nm		3.71	3.68
				lb-in		32.8	32.5
	Rated Speed		Nrtd	rpm		1600	2250
	Rated Power (speed) (1)(2)(4)		Prtd	kW		0.622	0.866
Hp					0.833	1.16	
240 V AC	Rated Torque (speed) (1)(2)(4)		Trtd	Nm	3.64	3.44	3.20
				lb-in	32.2	30.4	28.3
	Rated Speed		Nrtd	rpm	2300	3350	4600
	Rated Power (speed) (1)(2)(4)		Prtd	kW	0.878	1.21	1.54
Hp				1.18	1.62	2.07	
400 V AC	Rated Torque (speed) (1)(2)(4)		Trtd	Nm	3.33	2.83	1.88
				lb-in	29.5	25.1	16.6
	Rated Speed		Nrtd	rpm	4000	5800	8000
	Rated Power (speed) (1)(2)(4)		Prtd	kW	1.39	1.72	1.57
Hp				1.87	2.31	2.11	
480 V AC	Rated Torque (speed) (1)(2)(4)		Trtd	Nm	3.14	2.42	
				lb-in	27.8	21.4	
	Rated Speed		Nrtd	rpm	4800	7000	
	Rated Power (speed) (1)(2)(4)		Prtd	kW	1.58	1.77	
Hp				2.11	2.38		

UN	Parameter	Tolerance	Symbol	Units	AKM2G		
					33E	33G	33H
	Torque Constant (1)	+/- 10%	Kt	Nm/Arms	1.33	0.924	0.683
				lb-in/Arms	11.7	8.18	6.04
	Back EMF Constant (6)	+/- 10%	Ke	Vrms/krpm	85.6	59.7	44.1
	Motor Constant (1)	Nom	Km	Nm/ \sqrt{W}	0.429	0.426	0.431
				lb-in/ \sqrt{W}	3.80	3.77	3.82
	Resistance (line-line) (6)	+/- 10%	Rm	Ω	6.35	3.14	1.67
	Inductance Q-Axis (line-line)		Lqll	mH	15.1	7.3	4.0
	Inductance D-Axis (line-line)		Ldll	mH	TBD	TBD	TBD
	Inductance Saturation Current		Lisat	Arms	54.4	78.0	105.5
Maximum Demagnetization Current		Midpeak	Arms	TBD	TBD	TBD	

Parameter	Symbol	Units	AKM2G		
			33E	33G	33H
Mechanical Data					
Inertia (incl. Resolver feedback) (3)	Jm	kgcm ²	1.200		
		lb-in-s ²	1.06E-03		
Optional Brake Inertia (additional)	Jm	kgcm ²	0.120		
		lb-in-s ²	1.06E-04		
Weight (8)	W	kg	3.3		
		lb	7.2		
Static Friction (1)	Tf	Nm	0.031		
		lb-in	0.27		
Viscous Damping (1)	Kdv	Nm/krpm	0.0117		
		lb-in/krpm	0.104		
Thermal Time Constant	TCT	mins.	25		
Thermal Resistance	Rthw-a	°C/W	0.795		
Pole Pairs	PP		4		
Heatsink Size			10" x 10" x 1/4" Aluminum Plate		

1. Motor winding at temp. rise, $\delta T = 100^{\circ}\text{C}$, at 40°C ambient
2. All data referenced to sinusoidal commutation
3. Add parking brake if applicable for total inertia
4. Motor with resolver feedback and standard heat sink
5. May be limited at some values of V_{bus}
6. Measured at 25°C
7. See de-rate chart for the de-rate of different motor options.
8. Brake motor adds 0.72 kg [1.6 lbs]
9. Shaft seal increases Static Friction by 0.017 Nm [0.15 lb-in]

Brake options are listed in chapter "Technical Data Brakes" from [Technical Data Brakes](#).

7.3.5.1 AKM2G-33 Derates for Different Options

Note: Derate information is for general estimation only. For the most accurate information for your motor use the online Performance Curve Generator located at pcgh.kollmorgen.com, the AKM2G Performance Curves document available for download at www.kollmorgen.com/sites/default/files/public_downloads/AKM2G%20Performance%20Curves_0.pdf, or refer to Kollmorgen's Motioneering Software Tool at www.kollmorgen.com/en-us/service-and-support/technical/motioneering-online/.

De-rates are referenced to the Max Continuous Torque ΔT wdg. = 100°C

Options - No Brake	Speed: RPM								
	0	1000	2000	3000	4000	5000	6000	7000	8000
Resolver	100.0%	96.1%	91.0%	85.6%	79.9%	73.7%	67.1%	60.1%	52.4%
Resolver/Seal	99.8%	95.8%	90.6%	85.0%	79.1%	72.8%	66.1%	58.8%	50.8%
SFD	100.0%	96.1%	91.0%	85.6%	78.3%	70.3%	61.8%	52.6%	42.7%
SFD/Seal	99.8%	95.8%	90.6%	85.0%	77.3%	69.0%	60.1%	50.4%	39.8%
DSL	100.0%	96.1%	90.3%	83.0%	75.2%	66.8%	57.7%	47.8%	
DSL/Seal	99.8%	95.8%	89.8%	82.3%	74.2%	65.4%	55.9%	45.4%	
EnDat2.2	99.7%	94.3%	87.1%	79.4%	71.0%	62.0%	52.1%		
EnDat2.2/Seal	99.5%	94.0%	86.6%	78.6%	69.9%	60.5%	50.0%		

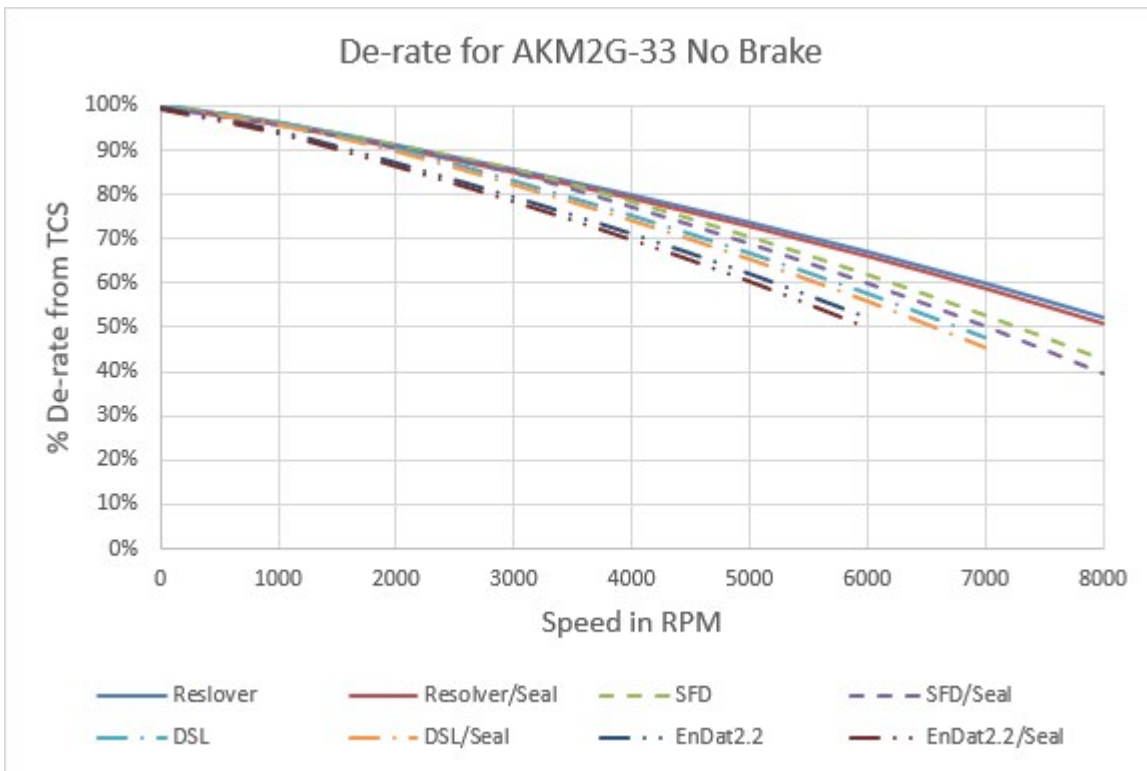

De-rates are referenced to the Max Continuous Torque ΔT wdg. = 100°C

Options - Brake	Speed: RPM								
	0	1000	2000	3000	4000	5000	6000	7000	8000
Resolver	97.7%	93.8%	88.6%	83.0%	77.1%	69.7%	61.2%	52.1%	42.1%
Resolver/Seal	97.5%	93.5%	88.1%	82.5%	76.4%	68.4%	59.5%	49.8%	39.2%
SFD	97.7%	93.8%	88.6%	81.4%	73.5%	64.9%	55.7%	45.5%	
SFD/Seal	97.5%	93.5%	88.1%	80.6%	72.4%	63.5%	53.8%	43.0%	
DSL	97.7%	93.3%	86.0%	78.3%	69.9%	60.7%	50.7%	39.5%	
DSL/Seal	97.5%	92.9%	85.5%	77.4%	68.7%	59.2%	48.7%	36.6%	
EnDat2.2	94.5%	88.6%	80.7%	72.1%	62.8%	52.3%	40.4%		
EnDat2.2/Seal	94.2%	88.2%	80.1%	71.2%	61.5%	50.6%	37.9%		

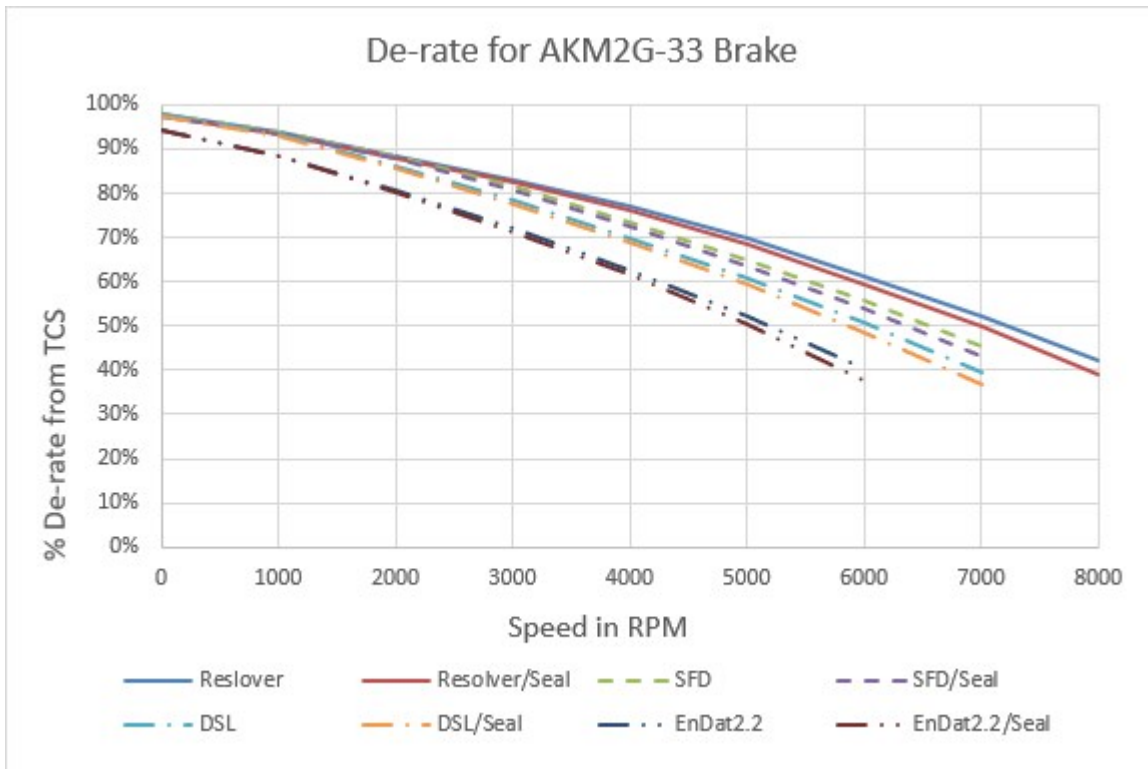

Note: For EnDat feedback motors acceleration of the motor is limited to $\leq 1 \cdot 10^5$ rad/s². The connected servo drive may further limit this value.

7.3.6 Technical Data AKM2G-33L

UN	Parameter	Tolerance	Symbol	Units	AKM2G	
					ML	PL
Electrical data						
	Max. Rated DC Bus Voltage	Max	V bus	V dc	170	170
	Max. Continuous Torque for ΔT winding = 100°C (1)(2)(4)	Nom	Tmc	Nm	3.82	3.83
				lb-in	33.8	33.9
	Max. Continuous Current for ΔT winding = 100°C (1)(2)(4)	Nom	Imc	Arms	14.8	20.0
	Max. Continuous Torque for ΔT winding = 60°C (2)(4)	Nom	Tmc	Nm	2.97	3.01
				lb-in	26.3	26.7
	Max. mechanical speed (5)	Nom	Nmax	rpm	8000	8000
Peak Torque (1)(2)(4)	Nom	Tp	Nm	14.5	14.6	
			lb-in	128	130	
Peak Current	Nom	Ip	Arms	59.0	80.8	
24 V DC	Rated Torque (speed) (1)(2)(4)		Trtd	Nm		3.82
				lb-in		33.8
	Rated Speed		Nrtd	rpm		800
	Rated Power (speed) (1)(2)(4)		Prtd	kW		0.320
Hp					0.430	
48 V DC	Rated Torque (speed) (1)(2)(4)		Trtd	Nm	3.69	3.64
				lb-in	32.6	32.2
	Rated Speed		Nrtd	rpm	1500	2100
	Rated Power (speed) (1)(2)(4)		Prtd	kW	0.579	0.801
Hp				0.777	1.07	
72 V DC	Rated Torque (speed) (1)(2)(4)		Trtd	Nm	3.54	3.38
				lb-in	31.3	30.0
	Rated Speed		Nrtd	rpm	2400	3400
	Rated Power (speed) (1)(2)(4)		Prtd	kW	0.890	1.21
Hp				1.19	1.62	
96 V DC	Rated Torque (speed) (1)(2)(4)		Trtd	Nm	3.34	3.06
				lb-in	29.6	27.1
	Rated Speed		Nrtd	rpm	3400	4700
	Rated Power (speed) (1)(2)(4)		Prtd	kW	1.19	1.50
Hp				1.60	2.02	

UN	Parameter	Tolerance	Symbol	Units	AKM2G	
					ML	PL
	Torque Constant (1)	+/- 10%	Kt	Nm/Arms	0.265	0.196
				lb-in/Arms	2.34	1.731
	Back EMF Constant (6)	+/- 10%	Ke	Vrms/krpm	17.2	12.7
	Motor Constant (1)	Nom	Km	Nm/√W	0.422	0.428
				lb-in/√W	3.74	3.79
	Resistance (line-line) (6)	+/- 10%	Rm	Ω	0.262	0.139
	Inductance Q-Axis (line-line)		Lqll	mH	0.61	0.33
	Inductance D-Axis (line-line)		Ldll	mH	TBD	TBD
	Inductance Saturation Current		Lisat	Arms	270	266
Maximum Demagnetization Current		Midpeak	Arms	TBD	TBD	

Parameter	Symbol	Units	AKM2G		
			ML	PL	QL
Mechanical Data					
Inertia (incl. Resolver feedback) (3)	Jm	kgcm ²	1.200		
		lb-in-s ²	1.06E-03		
Optional Brake Inertia (additional)	Jm	kgcm ²	0.120		
		lb-in-s ²	1.06E-04		
Weight (8)	W	kg	3.3		
		lb	7.2		
Static Friction (1)	Tf	Nm	0.031		
		lb-in	0.27		
Viscous Damping (1)	Kdv	Nm/krpm	0.0117		
		lb-in/krpm	0.104		
Thermal Time Constant	TCT	mins.	25		
Thermal Resistance	Rthw-a	°C/W	0.795		
Pole Pairs	PP		4		
Heatsink Size			10" x 10" x 1/4" Aluminum Plate		

1. Motor winding at temp. rise, $\delta T = 100^{\circ}\text{C}$, at 40°C ambient
2. All data referenced to sinusoidal commutation
3. Add parking brake if applicable for total inertia
4. Motor with resolver feedback and standard heat sink
5. May be limited at some values of V_{bus}
6. Measured at 25°C
7. See de-rate chart for the de-rate of different motor options.
8. Brake motor adds 0.72 kg [1.6 lbs]
9. Shaft seal increases Static Friction by 0.017 Nm [0.15 lb-in]

Brake options are listed in chapter "Technical Data Brakes" from [Technical Data Brakes](#).

7.3.6.1 AKM2G-33L Derates for Different Options

Note: Derate information is for general estimation only. For the most accurate information for your motor use the online Performance Curve Generator located at pcgh.kollmorgen.com, the AKM2G Performance Curves document available for download at www.kollmorgen.com/sites/default/files/public_downloads/AKM2G%20Performance%20Curves_0.pdf, or refer to Kollmorgen's Motioneering Software Tool at www.kollmorgen.com/en-us/service-and-support/technical/motioneering-online/.

De-rates are referenced to the Max Continuous Torque ΔT wdg. = 100°C

Options - No Brake	Speed: RPM							
	0	1000	2000	3000	4000	4500	5000	5400
Resolver	100.0%	96.6%	92.0%	87.1%	81.7%	78.9%	76.1%	73.7%
Resolver/Seal	99.8%	96.3%	91.6%	86.5%	81.1%	78.2%	75.2%	72.8%
SFD	100.0%	96.6%	92.0%	87.1%	81.7%	78.9%	76.1%	73.5%
SFD/Seal	99.8%	96.3%	91.6%	86.5%	81.1%	78.2%	75.0%	72.2%
DSL	100.0%	96.6%	92.0%	86.4%	80.0%	76.6%	73.2%	70.4%
DSL/Seal	99.8%	96.3%	91.6%	85.7%	79.0%	75.5%	72.0%	69.1%
EnDat2.2	100.0%	95.5%	89.5%	83.1%	76.3%	72.8%	69.2%	66.3%
EnDat2.2/Seal	99.7%	95.1%	89.0%	82.3%	75.3%	71.7%	67.9%	64.9%

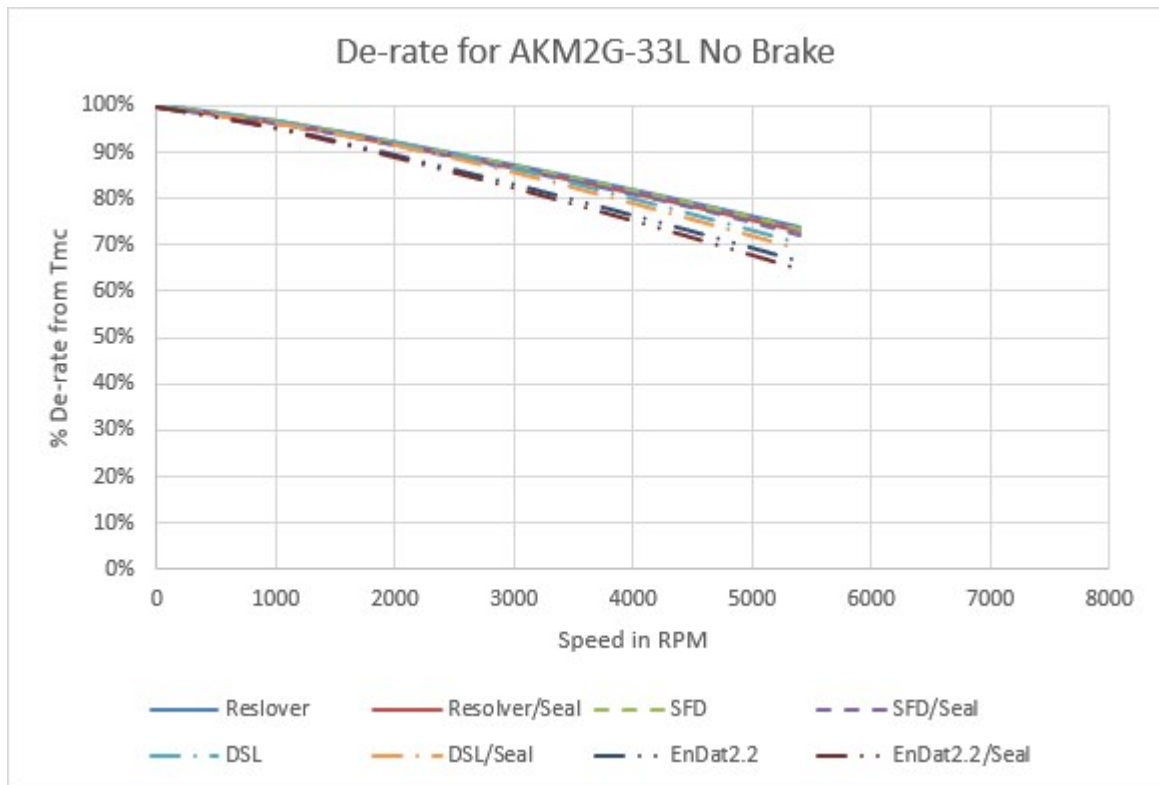

De-rates are referenced to the Max Continuous Torque ΔT wdg. = 100°C

Options - Brake	Speed: RPM								
	0	1000	2000	3000	4000	5000	6000	7000	8000
Resolver	97.7%	93.8%	88.6%	83.0%	77.1%	69.7%	61.2%	52.1%	42.1%
Resolver/Seal	97.5%	93.5%	88.1%	82.5%	76.4%	68.4%	59.5%	49.8%	39.2%
SFD	97.7%	93.8%	88.6%	81.4%	73.5%	64.9%	55.7%	45.5%	
SFD/Seal	97.5%	93.5%	88.1%	80.6%	72.4%	63.5%	53.8%	43.0%	
DSL	97.7%	93.3%	86.0%	78.3%	69.9%	60.7%	50.7%	39.5%	
DSL/Seal	97.5%	92.9%	85.5%	77.4%	68.7%	59.2%	48.7%	36.6%	
EnDat2.2	94.5%	88.6%	80.7%	72.1%	62.8%	52.3%	40.4%		
EnDat2.2/Seal	94.2%	88.2%	80.1%	71.2%	61.5%	50.6%	37.9%		

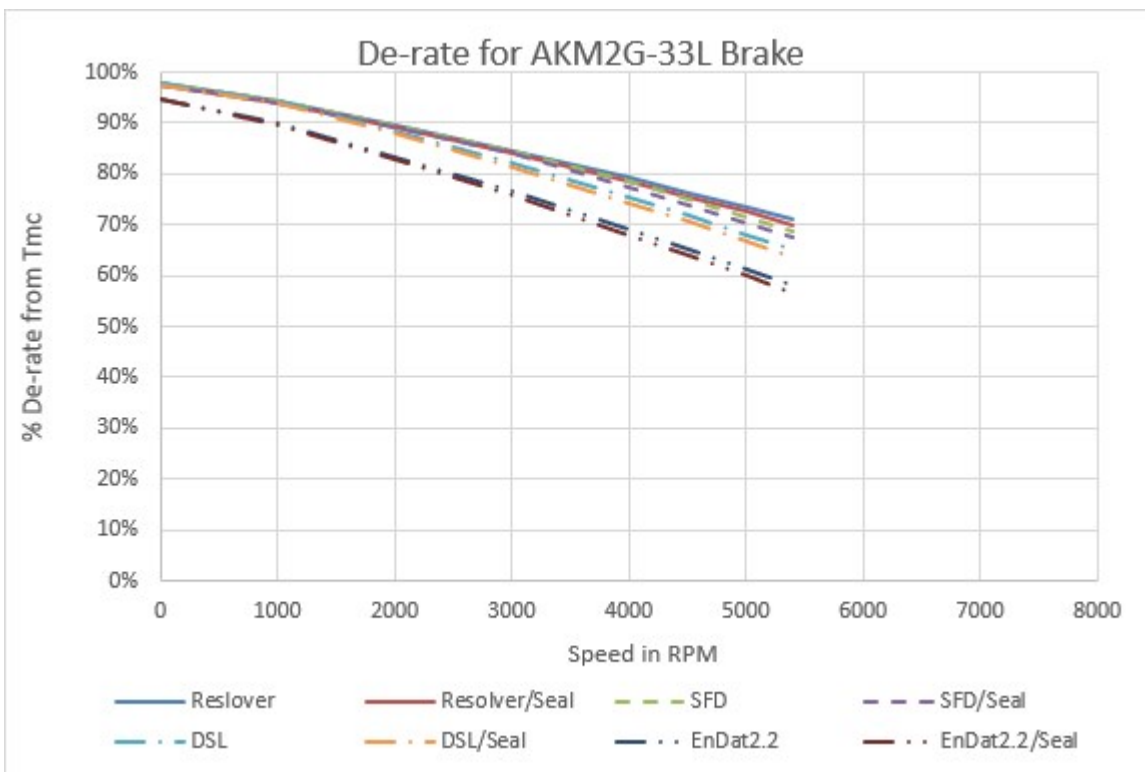

Note: For EnDat feedback motors acceleration of the motor is limited to $\leq 1 \cdot 10^5$ rad/s². The connected servo drive may further limit this value.

7.4 Technical Data AKM2G-4x Series

7.4.1 Technical Data AKM2G-41

UN	Parameter	Tolerance	Symbol	Units	AKM2G		
					41D	41E	41G
Electrical data							
	Max. Rated Equivalent Line Voltage	Max	V bus	V ac	480	480	480
	Max. Continuous Torque for ΔT winding = 100°C (1)(2)(4)	Nom	Tmc	Nm	2.85	2.87	2.86
				ib-in	25.2	25.4	25.3
	Max. Continuous Current for ΔT winding = 100°C (1)(2)(4)	Nom	Imc	Arms	2.32	2.92	4.53
	Max. Continuous Torque for ΔT winding = 60°C (2)(4)	Nom	Tmc	Nm	2.22	2.24	2.24
				lb-in	19.7	19.8	19.9
	Max. mechanical speed (5)	Nom	Nmax	rpm	6000	6000	6000
	Peak Torque (1)(2)(4)	Nom	Tp	Nm	7.25	7.26	7.26
				lb-in	64.2	64.2	64.2
	Peak Current	Nom	Ip	Arms	9.27	11.7	18.1
120 V AC	Rated Torque (speed) (1)(2)(4)		Trtd	Nm	2.84	2.84	2.79
				lb-in	25.1	25.1	24.7
	Rated Speed		Nrtd	rpm	900	1200	2100
	Rated Power (speed) (1)(2)(4)		Prtd	kW	0.267	0.357	0.613
Hp				0.358	0.478	0.823	
240 V AC	Rated Torque (speed) (1)(2)(4)		Trtd	Nm	2.76	2.73	2.57
				lb-in	24.4	24.2	22.7
	Rated Speed		Nrtd	rpm	2100	2700	4500
	Rated Power (speed) (1)(2)(4)		Prtd	kW	0.607	0.773	1.21
Hp				0.814	1.04	1.62	
400 V AC	Rated Torque (speed) (1)(2)(4)		Trtd	Nm	2.62	2.52	2.28
				lb-in	23.2	22.3	20.1
	Rated Speed		Nrtd	rpm	3800	4800	6000
	Rated Power (speed) (1)(2)(4)		Prtd	kW	1.04	1.27	1.43
Hp				1.40	1.70	1.92	
480 V AC	Rated Torque (speed) (1)(2)(4)		Trtd	Nm	2.53	2.38	2.19
				lb-in	22.4	21.1	19.4
	Rated Speed		Nrtd	rpm	4600	5900	6000
	Rated Power (speed) (1)(2)(4)		Prtd	kW	1.22	1.47	1.37
Hp				1.63	1.97	1.84	

UN	Parameter	Tolerance	Symbol	Units	AKM2G		
					41D	41E	41G
	Torque Constant (1)	+/- 10%	Kt	Nm/Arms	1.24	0.99	0.64
				lb-in/Arms	11.0	8.76	5.64
	Back EMF Constant (6)	+/- 10%	Ke	Vrms/krpm	82.2	65.6	42.2
	Motor Constant (1)	Nom	Km	Nm/ \sqrt{W}	0.327	0.329	0.330
				lb-in/ \sqrt{W}	2.89	2.91	2.92
	Resistance (line-line) (6)	+/- 10%	Rm	Ω	9.61	6.04	2.49
	Inductance Q-Axis (line-line)		Lqll	mH	56.5	36.0	14.9
	Inductance D-Axis (line-line)		Ldll	mH	TBD	TBD	TBD
	Inductance Saturation Current		Lisat	Arms	11.9	15.0	23.3
	Maximum Demagnetization Current		Midpeak	Arms	TBD	TBD	TBD

Parameter	Symbol	Units	AKM2G		
			41D	41E	41G
Mechanical Data					
Inertia (incl. Resolver feedback) (3)	Jm	kgcm ²	0.774		
		lb-in-s ²	6.85E-04		
Optional Brake Inertia (additional)	Jm	kgcm ²	0.360		
		lb-in-s ²	3.19E-04		
Weight (8)	W	kg	2.90		
		lb	6.39		
Static Friction (1)	Tf	Nm	0.0230		
		lb-in	0.2036		
Viscous Damping (1)	Kdv	Nm/krpm	0.00450		
		lb-in/krpm	0.0398		
Thermal Time Constant	TCT	mins.	17		
Thermal Resistance	Rthw-a	°C/W	0.880		
Pole Pairs	PP		5		
Heatsink Size			10" x 10" x 1/4" Aluminum Plate		

1. Motor winding at temp. rise, $\delta T = 100^{\circ}\text{C}$, at 40°C ambient
2. All data referenced to sinusoidal commutation
3. Add parking brake if applicable for total inertia
4. Motor with resolver feedback and standard heat sink
5. May be limited at some values of V_{bus}
6. Measured at 25°C
7. See de-rate chart for the de-rate of different motor options.
8. Brake motor adds 0.45 kg [1.0 lbs]
9. Shaft seal increases Static Friction by 0.020 Nm [0.21 lb-in]

Brake options are listed in chapter "Technical Data Brakes" from [Technical Data Brakes](#).

7.4.1.1 AKM2G-41 Derates for Different Options

Note: Derate information is for general estimation only. For the most accurate information for your motor use the online Performance Curve Generator located at pcgh.kollmorgen.com, the AKM2G Performance Curves document available for download at www.kollmorgen.com/sites/default/files/public_downloads/AKM2G%20Performance%20Curves_0.pdf, or refer to Kollmorgen's Motioneering Software Tool at www.kollmorgen.com/en-us/service-and-support/technical/motioneering-online/.

De-rates are referenced to the Max Continuous Torque ΔT wdg. = 100°C

Options - No Brake	Speed: RPM						
	0	1000	2000	3000	4000	5000	6000
Resolver	100.0%	96.9%	93.0%	89.0%	84.9%	80.7%	76.4%
Resolver/Seal	99.1%	95.6%	91.1%	86.5%	81.8%	77.0%	71.9%
SFD	100.0%	96.9%	93.0%	89.0%	84.9%	80.7%	76.4%
SFD/Seal	99.1%	95.6%	91.1%	86.5%	81.8%	77.0%	71.9%
DSL	100.0%	96.9%	93.0%	89.0%	84.9%	80.7%	76.4%
DSL/Seal	99.1%	95.6%	91.1%	86.5%	81.8%	77.0%	71.9%
EnDat2.2	100.0%	96.9%	93.0%	89.0%	84.9%	80.7%	74.6%
EnDat2.2/Seal	99.1%	95.6%	91.1%	86.5%	80.9%	73.2%	64.7%

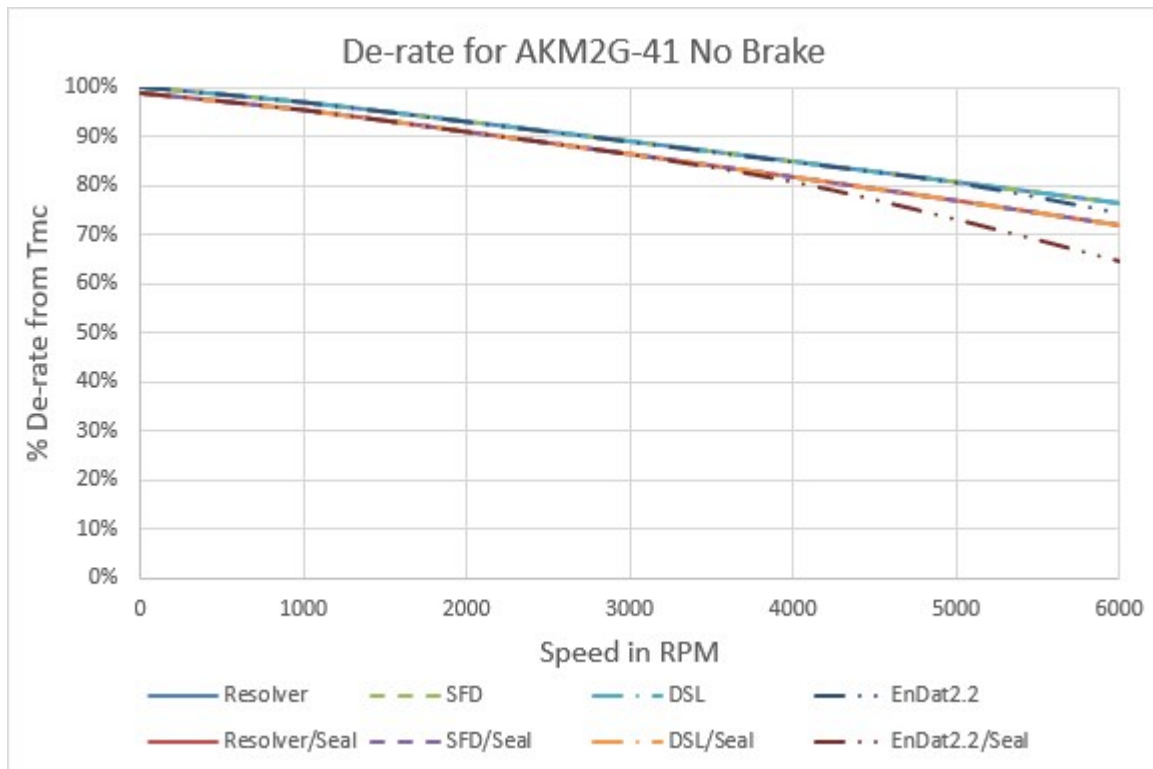

De-rates are referenced to the Max Continuous Torque ΔT wdg. = 100°C

Options - Brake	Speed: RPM						
	0	1000	2000	3000	4000	5000	6000
Resolver	100.0%	96.9%	93.0%	89.0%	84.9%	80.7%	76.4%
Resolver/Seal	99.1%	95.6%	91.1%	86.5%	81.8%	77.0%	71.9%
SFD	100.0%	96.9%	93.0%	89.0%	84.9%	80.7%	76.4%
SFD/Seal	99.1%	95.6%	91.1%	86.5%	81.8%	77.0%	71.9%
DSL	100.0%	96.9%	93.0%	89.0%	84.9%	80.7%	76.4%
DSL/Seal	99.1%	95.6%	91.1%	86.5%	81.8%	77.0%	71.9%
EnDat2.2	100.0%	96.9%	93.0%	89.0%	84.9%	80.7%	74.6%
EnDat2.2/Seal	99.1%	95.6%	91.1%	86.5%	80.9%	73.2%	64.7%

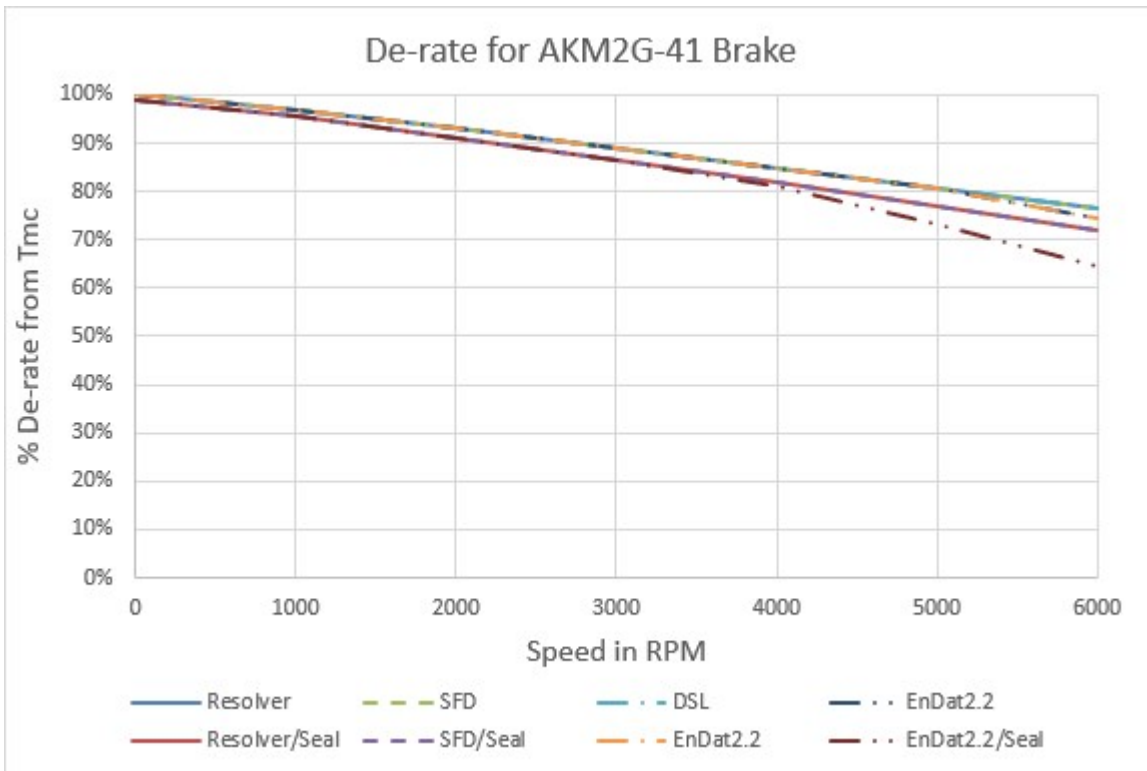

Note: For EnDat feedback motors acceleration of the motor is limited to $\leq 1 \cdot 10^5$ rad/s². The connected servo drive may further limit this value.

7.4.2 Technical Data AKM2G-41L

UN	Parameter	Tolerance	Symbol	Units	AKM2G	
					ML	PL
Electrical data						
24 V DC	Rated Torque (speed) (1)(2)(4)		Trtd	Nm		2.89
				lb-in		25.6
	Rated Speed		Nrtd	rpm		1000
	Rated Power (speed) (1)(2)(4)		Prtd	kW		0.303
Hp					0.406	
48 V DC	Rated Torque (speed) (1)(2)(4)		Trtd	Nm	2.85	2.80
				lb-in	25.2	24.8
	Rated Speed		Nrtd	rpm	1600	2300
	Rated Power (speed) (1)(2)(4)		Prtd	kW	0.477	0.674
Hp				0.639	0.904	
72 V DC	Rated Torque (speed) (1)(2)(4)		Trtd	Nm	2.78	2.68
				lb-in	24.6	23.7
	Rated Speed		Nrtd	rpm	2500	3600
	Rated Power (speed) (1)(2)(4)		Prtd	kW	0.727	1.01
Hp				0.97	1.35	
96 V DC	Rated Torque (speed) (1)(2)(4)		Trtd	Nm	2.69	2.51
				lb-in	23.8	22.2
	Rated Speed		Nrtd	rpm	3400	5000
	Rated Power (speed) (1)(2)(4)		Prtd	kW	0.96	1.31
Hp				1.28	1.76	
	Torque Constant (1)	+/- 10%	Kt	Nm/Arms	0.209	0.147
				lb-in/Arms	1.85	1.30
	Back EMF Constant (6)	+/- 10%	Ke	Vrms/krpm	13.8	9.75
	Motor Constant (1)	Nom	Km	Nm/ \sqrt{W}	0.333	0.334
				lb-in/ \sqrt{W}	2.95	2.96
	Resistance (line-line) (6)	+/- 10%	Rm	Ω	0.262	0.130
	Inductance Q-Axis (line-line)		Lqll	mH	1.6	0.80
	Inductance D-Axis (line-line)		Ldll	mH	TBD	TBD
Inductance Saturation Current		Lisat	Arms	71	101	
Maximum Demagnetization Current		Midpeak	Arms	TBD	TBD	

Parameter	Symbol	Units	AKM2G		
			ML	PL	QL
Mechanical Data					
Inertia (incl. Resolver feedback) (3)	Jm	kgcm ²	0.774		
			lb-in-s ²		
Optional Brake Inertia (additional)	Jm	kgcm ²	0.360		
			lb-in-s ²		

Parameter	Symbol	Units	AKM2G		
			ML	PL	QL
Weight (8)	W	kg	2.90		
		lb	6.39		
Static Friction (1)	Tf	Nm	0.0230		
		lb-in	0.2036		
Viscous Damping (1)	Kdv	Nm/krpm	0.00450		
		lb-in/krpm	0.0398		
Thermal Time Constant	TCT	mins.	17		
Thermal Resistance	Rthw-a	°C/W	0.880		
Pole Pairs	PP		5		
Heatsink Size			10" x 10" x 1/4" Aluminum Plate		

1. Motor winding at temp. rise, $\delta T = 100^{\circ}\text{C}$, at 40°C ambient
2. All data referenced to sinusoidal commutation
3. Add parking brake if applicable for total inertia
4. Motor with resolver feedback and standard heat sink
5. May be limited at some values of V_{bus}
6. Measured at 25°C
7. See de-rate chart for the de-rate of different motor options.
8. Brake motor adds 0.45 kg [1.0 lbs]
9. Shaft seal increases Static Friction by 0.020 Nm [0.21 lb-in]

Brake options are listed in chapter "Technical Data Brakes" from [Technical Data Brakes](#).

7.4.2.1 AKM2G-41L Derates for Different Options

Note: Derate information is for general estimation only. For the most accurate information for your motor use the online Performance Curve Generator located at pcgh.kollmorgen.com, the AKM2G Performance Curves document available for download at www.kollmorgen.com/sites/default/files/public_downloads/AKM2G%20Performance%20Curves_0.pdf, or refer to Kollmorgen's Motioneering Software Tool at www.kollmorgen.com/en-us/service-and-support/technical/motioneering-online/.

De-rates are referenced to the Max Continuous Torque ΔT wdg. = 100°C

Options - No Brake	Speed: RPM							
	0	500	1000	2000	3000	4000	5000	5700
Resolver	100.0%	99.1%	97.6%	94.5%	91.4%	88.2%	85.0%	82.7%
Resolver/Seal	99.1%	98.1%	96.3%	92.7%	89.0%	85.2%	81.4%	78.6%
SFD	100.0%	99.1%	97.6%	94.5%	91.4%	88.2%	85.0%	82.7%
SFD/Seal	99.1%	98.1%	96.3%	92.7%	89.0%	85.2%	81.4%	78.6%
DSL	100.0%	99.1%	97.6%	94.5%	91.4%	88.2%	85.0%	82.7%
DSL/Seal	99.1%	98.1%	96.3%	92.7%	89.0%	85.2%	81.4%	78.6%
EnDat2.2	100.0%	99.1%	97.6%	94.5%	91.4%	88.2%	85.0%	82.7%
EnDat2.2/Seal	99.1%	98.1%	96.3%	92.7%	89.0%	85.2%	79.4%	74.8%

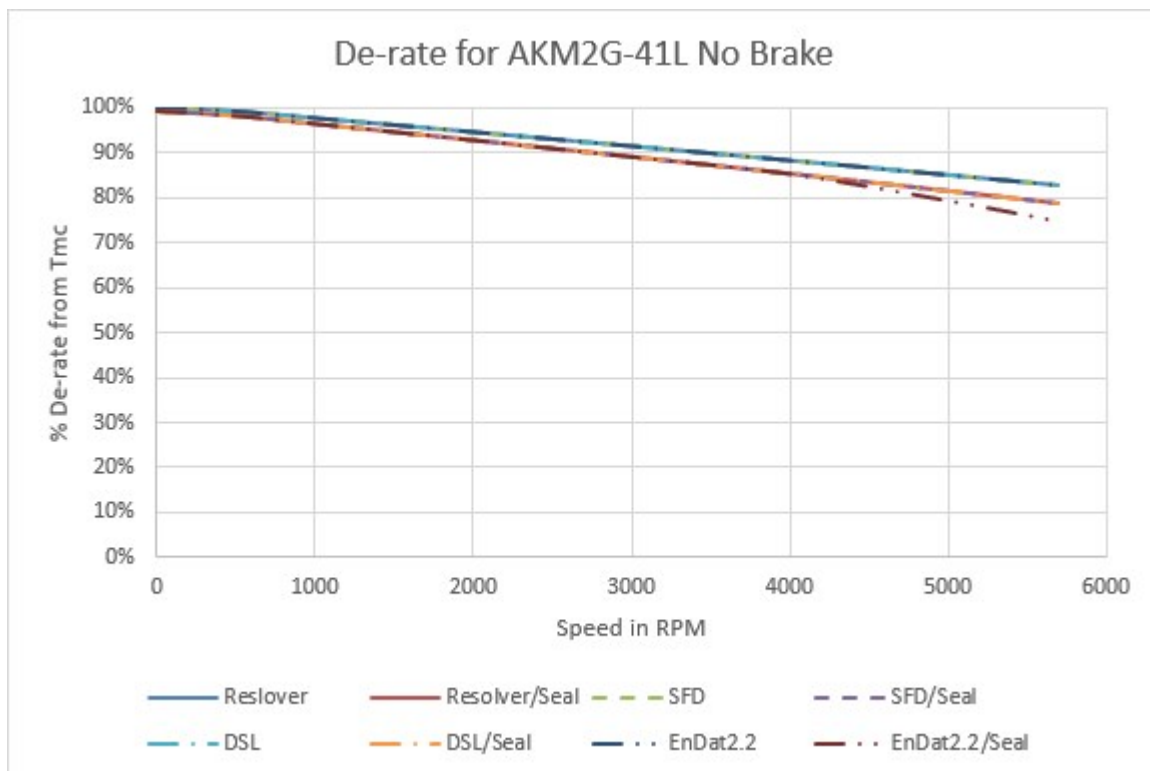

De-rates are referenced to the Max Continuous Torque ΔT wdg. = 100°C

Options - Brake	Speed: RPM							
	0	500	1000	2000	3000	4000	5000	5700
Resolver	100.0%	99.1%	97.6%	94.5%	91.4%	88.2%	85.0%	82.7%
Resolver/Seal	99.1%	98.1%	96.3%	92.7%	89.0%	85.2%	81.4%	78.6%
SFD	100.0%	99.1%	97.6%	94.5%	91.4%	88.2%	85.0%	82.7%
SFD/Seal	99.1%	98.1%	96.3%	92.7%	89.0%	85.2%	81.4%	78.6%
DSL	100.0%	99.1%	97.6%	94.5%	91.4%	88.2%	85.0%	82.7%
DSL/Seal	99.1%	98.1%	96.3%	92.7%	89.0%	85.2%	81.4%	78.6%
EnDat2.2	100.0%	99.1%	97.6%	94.5%	91.4%	88.2%	85.0%	82.5%
EnDat2.2/Seal	99.1%	98.1%	96.3%	92.7%	89.0%	84.9%	78.6%	73.9%

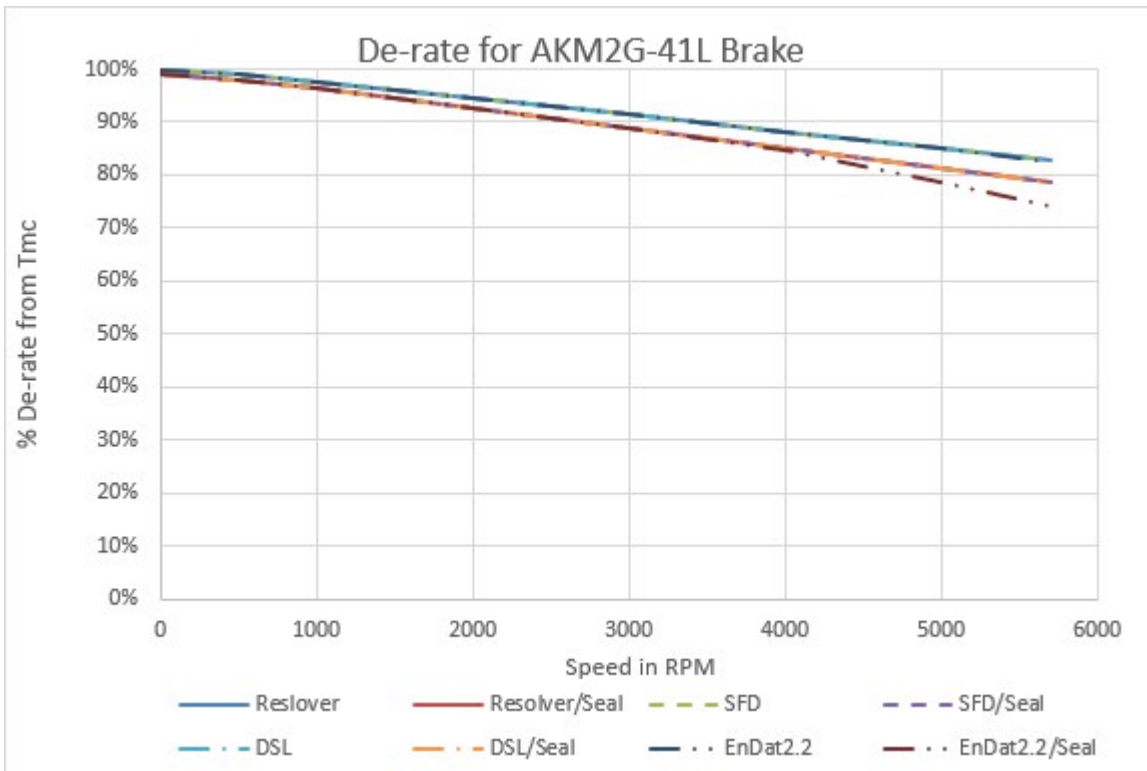

Note: For EnDat feedback motors acceleration of the motor is limited to $\leq 1 \cdot 10^5$ rad/s². The connected servo drive may further limit this value.

7.4.3 Technical Data AKM2G-42

UN	Parameter	Tolerance	Symbol	Units	AKM2G		
					42D	42E	42H
Electrical data							
	Max. Rated Equivalent Line Voltage	Max	V bus	V ac	480	480	480
	Max. Continuous Torque for ΔT winding = 100°C (1)(2)(4)	Nom	Tmc	Nm	5.04	5.08	5.12
				ib-in	44.6	45.0	45.3
	Max. Continuous Current for ΔT winding = 100°C (1)(2)(4)	Nom	Imc	Arms	2.27	2.88	5.64
	Max. Continuous Torque for ΔT winding = 60°C (2)(4)	Nom	Tmc	Nm	3.93	3.97	4.02
				lb-in	34.8	35.1	35.6
	Max. mechanical speed (5)	Nom	Nmax	rpm	6000	6000	6000
	Peak Torque (1)(2)(4)	Nom	Tp	Nm	14.35	14.40	14.44
				lb-in	127.0	127.4	127.8
	Peak Current	Nom	Ip	Arms	9.07	11.5	22.6
120 V AC	Rated Torque (speed) (1)(2)(4)		Trtd	Nm			5.00
				lb-in			44.3
	Rated Speed		Nrtd	rpm			1500
	Rated Power (speed) (1)(2)(4)		Prtd	kW			0.79
Hp						1.05	
240 V AC	Rated Torque (speed) (1)(2)(4)		Trtd	Nm	4.94	4.93	4.65
				lb-in	43.8	43.6	41.1
	Rated Speed		Nrtd	rpm	1200	1600	3200
	Rated Power (speed) (1)(2)(4)		Prtd	kW	0.62	0.83	1.56
Hp				0.83	1.11	2.09	
400 V AC	Rated Torque (speed) (1)(2)(4)		Trtd	Nm	4.79	4.71	3.87
				lb-in	42.4	41.7	34.3
	Rated Speed		Nrtd	rpm	2100	2700	5600
	Rated Power (speed) (1)(2)(4)		Prtd	kW	1.05	1.33	2.27
Hp				1.41	1.78	3.04	
480 V AC	Rated Torque (speed) (1)(2)(4)		Trtd	Nm	4.69	4.56	3.56
				lb-in	41.5	40.4	31.5
	Rated Speed		Nrtd	rpm	2600	3300	6000
	Rated Power (speed) (1)(2)(4)		Prtd	kW	1.28	1.58	2.23
Hp				1.71	2.11	3.00	

UN	Parameter	Tolerance	Symbol	Units	AKM2G		
					42D	42E	42H
	Torque Constant (1)	+/- 10%	Kt	Nm/Arms	2.24	1.77	0.913
				lb-in/Arms	19.8	15.7	8.1
	Back EMF Constant (6)	+/- 10%	Ke	Vrms/krpm	149.2	118.2	60.8
	Motor Constant (1)	Nom	Km	Nm/ \sqrt{W}	0.52	0.53	0.53
				lb-in/ \sqrt{W}	4.63	4.67	4.73
	Resistance (line-line) (6)	+/- 10%	Rm	Ω	12.19	7.52	1.94
	Inductance Q-Axis (line-line)		Lqll	mH	81.9	51.4	13.6
	Inductance D-Axis (line-line)		Ldll	mH	TBD	TBD	TBD
	Inductance Saturation Current		Lisat	Arms	13.4	16.9	32.9
Maximum Demagnetization Current		Midpeak	Arms	TBD	TBD	TBD	

Parameter	Symbol	Units	AKM2G		
			42D	42E	42H
Mechanical Data					
Inertia (incl. Resolver feedback) (3)	Jm	kgcm ²	1.36		
		lb-in-s ²	1.20E-03		
Optional Brake Inertia (additional)	Jm	kgcm ²	0.36		
		lb-in-s ²	3.19E-04		
Weight (8)	W	kg	3.86		
		lb	8.5		
Static Friction (1)	Tf	Nm	0.030		
		lb-in	0.27		
Viscous Damping (1)	Kdv	Nm/krpm	0.009		
		lb-in/krpm	0.08		
Thermal Time Constant	TCT	mins.	22		
Thermal Resistance	Rthw-a	°C/W	0.725		
Pole Pairs	PP		5		
Heatsink Size			10" x 10" x 1/4" Aluminum Plate		

1. Motor winding at temp. rise, $\delta T = 100^{\circ}\text{C}$, at 40°C ambient
2. All data referenced to sinusoidal commutation
3. Add parking brake if applicable for total inertia
4. Motor with resolver feedback and standard heat sink
5. May be limited at some values of V_{bus}
6. Measured at 25°C
7. See de-rate chart for the de-rate of different motor options.
8. Brake motor adds 0.45 kg [1.0 lbs]
9. Shaft seal increases Static Friction by 0.020 Nm [0.21 lb-in]

Brake options are listed in chapter "Technical Data Brakes" from [Technical Data Brakes](#).

7.4.3.1 AKM2G-42 Derates for Different Options

Note: Derate information is for general estimation only. For the most accurate information for your motor use the online Performance Curve Generator located at pcgh.kollmorgen.com, the AKM2G Performance Curves document available for download at www.kollmorgen.com/sites/default/files/public_downloads/AKM2G%20Performance%20Curves_0.pdf, or refer to Kollmorgen's Motioneering Software Tool at www.kollmorgen.com/en-us/service-and-support/technical/motioneering-online/.

De-rates are referenced to the Max Continuous Torque ΔT wdg. = 100°C

Options - No Brake	Speed: RPM						
	0	1000	2000	3000	4000	5000	6000
Resolver	100.0%	96.1%	91.1%	86.0%	80.8%	75.3%	69.5%
Resolver/Seal	99.5%	95.2%	89.6%	84.0%	78.1%	71.9%	65.1%
SFD	100.0%	96.1%	91.1%	86.0%	80.8%	75.3%	69.5%
SFD/Seal	99.5%	95.2%	89.6%	84.0%	78.1%	71.0%	61.4%
DSL	100.0%	96.1%	91.1%	86.0%	80.8%	75.3%	69.5%
DSL/Seal	99.5%	95.2%	89.6%	84.0%	78.1%	71.0%	61.4%
EnDat2.2	100.0%	96.1%	90.2%	83.5%	76.4%	68.5%	59.7%
EnDat2.2/Seal	99.5%	95.2%	87.9%	80.1%	71.3%	61.4%	49.8%

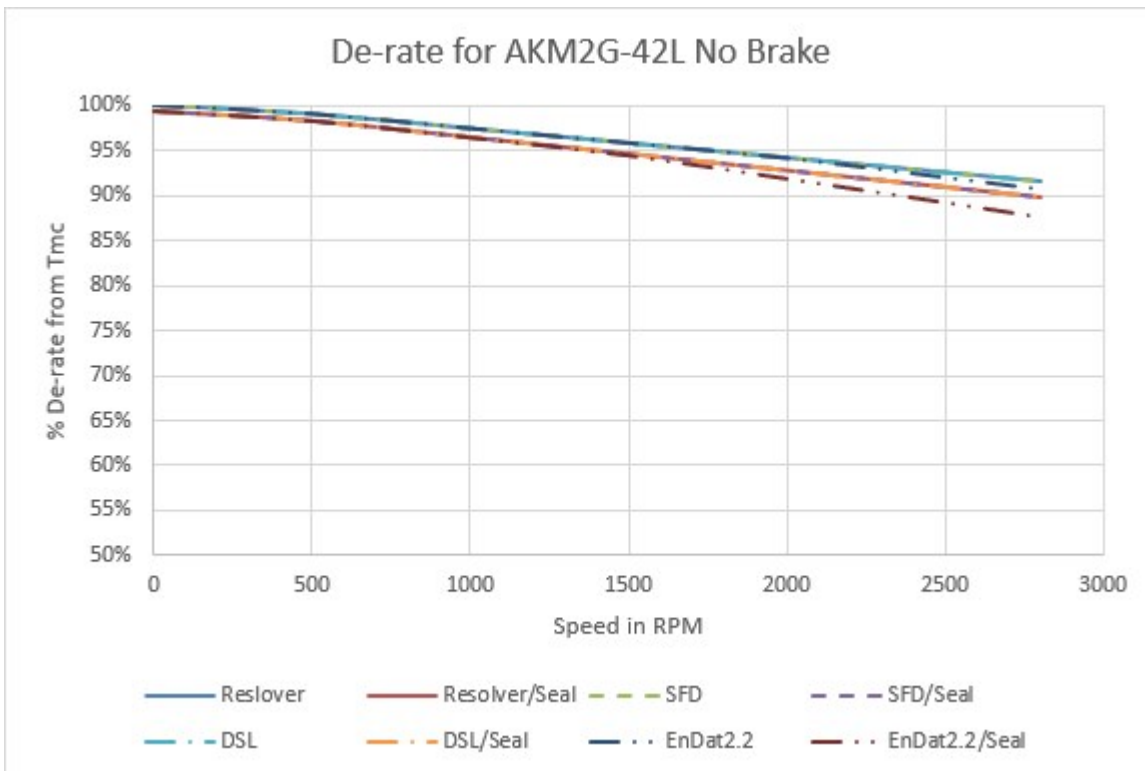

De-rates are referenced to the Max Continuous Torque ΔT wdg. = 100°C

Options - Brake	Speed: RPM						
	0	1000	2000	3000	4000	5000	6000
Resolver	100.0%	96.1%	91.1%	86.0%	80.8%	75.3%	69.5%
Resolver/Seal	99.5%	95.2%	89.6%	84.0%	78.1%	71.0%	61.4%
SFD	100.0%	96.1%	91.1%	86.0%	80.8%	75.3%	69.4%
SFD/Seal	99.5%	95.2%	89.6%	84.0%	78.1%	70.9%	61.2%
DSL	100.0%	96.1%	91.1%	86.0%	80.8%	75.3%	69.4%
DSL/Seal	99.5%	95.2%	89.6%	84.0%	78.1%	70.9%	61.2%
EnDat2.2	100.0%	96.1%	90.2%	83.5%	76.4%	68.5%	59.7%
EnDat2.2/Seal	99.5%	95.2%	87.9%	80.1%	71.3%	61.4%	49.8%

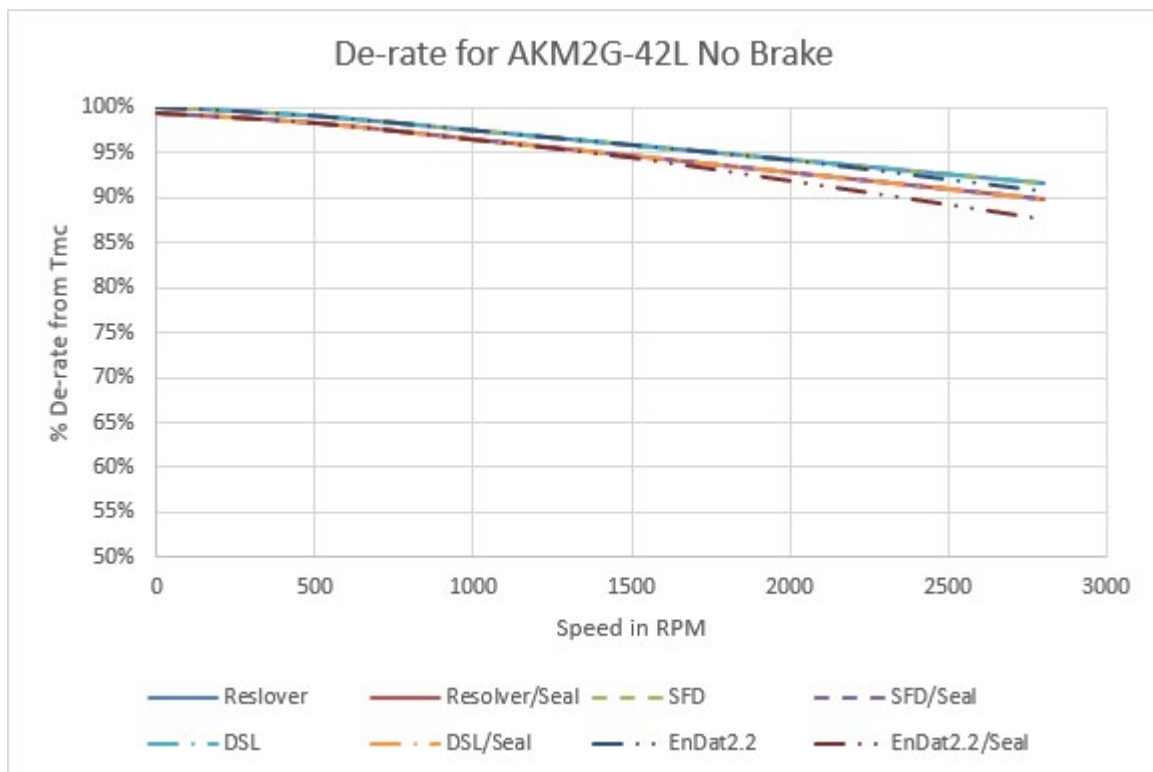

Note: For EnDat feedback motors acceleration of the motor is limited to $\leq 1 \cdot 10^5$ rad/s². The connected servo drive may further limit this value.

7.4.4 Technical Data AKM2G-42L

UN	Parameter	Tolerance	Symbol	Units	AKM2G		
					ML	NL	PL
Electrical data							
	Max. Rated DC Bus Voltage	Max	V bus	V dc	170	170	170
	Max. Continuous Torque for ΔT winding = 100°C (1)(2)(4)	Nom	Tmc	Nm	5.17	5.17	5.16
				ib-in	45.7	45.7	45.7
	Max. Continuous Current for ΔT winding = 100°C (1)(2)(4)	Nom	Imc	Arms	13.8	17.4	19.7
	Max. Continuous Torque for ΔT winding = 60°C (2)(4)	Nom	Tmc	Nm	4.03	4.03	4.02
				lb-in	35.6	35.7	35.6
	Max. mechanical speed (5)	Nom	Nmax	rpm	6000	6000	6000
	Peak Torque (1)(2)(4)	Nom	Tp	Nm	14.5	14.5	14.5
				lb-in	128	128	128
	Peak Current	Nom	Ip	Arms	55.1	69.8	78.8
24 V DC	Rated Torque (speed) (1)(2)(4)		Trtd	Nm		5.12	5.10
				lb-in		45.3	45.1
	Rated Speed		Nrtd	rpm		800	900
	Rated Power (speed) (1)(2)(4)		Prtd	kW		0.429	0.480
Hp					0.575	0.64	
48 V DC	Rated Torque (speed) (1)(2)(4)		Trtd	Nm	5.10	5.08	5.04
				lb-in	45.1	44.9	44.6
	Rated Speed		Nrtd	rpm	900	1100	1300
	Rated Power (speed) (1)(2)(4)		Prtd	kW	0.481	0.585	0.686
Hp				0.645	0.78	0.92	
72 V DC	Rated Torque (speed) (1)(2)(4)		Trtd	Nm	5.02	4.96	4.89
				lb-in	44.5	43.9	43.3
	Rated Speed		Nrtd	rpm	1400	1800	2100
	Rated Power (speed) (1)(2)(4)		Prtd	kW	0.736	0.93	1.08
Hp				0.988	1.25	1.44	
96 V DC	Rated Torque (speed) (1)(2)(4)		Trtd	Nm	4.93	4.81	4.73
				lb-in	43.6	42.6	41.8
	Rated Speed		Nrtd	rpm	1900	2500	2800
	Rated Power (speed) (1)(2)(4)		Prtd	kW	0.98	1.26	1.39
Hp				1.32	1.69	1.86	

UN	Parameter	Tolerance	Symbol	Units	AKM2G		
					ML	NL	PL
	Torque Constant (1)	+/- 10%	Kt	Nm/Arms	0.378	0.298	0.263
				lb-in/Arms	3.34	2.64	2.33
	Back EMF Constant (6)	+/- 10%	Ke	Vrms/krpm	25.2	19.9	17.6
	Motor Constant (1)	Nom	Km	Nm/ \sqrt{W}	0.536	0.536	0.536
				lb-in/ \sqrt{W}	4.74	4.75	4.74
	Resistance (line-line) (6)	+/- 10%	Rm	Ω	0.331	0.206	0.161
	Inductance Q-Axis (line-line)		Lqll	mH	2.3	1.5	1.1
	Inductance D-Axis (line-line)		Ldll	mH	TBD	TBD	TBD
	Inductance Saturation Current		Lisat	Arms	80	101	114
	Maximum Demagnetization Current		Midpeak	Arms	TBD	TBD	TBD

Parameter	Symbol	Units	AKM2G		
			ML	NL	PL
Mechanical Data					
Inertia (incl. Resolver feedback) (3)	Jm	kgcm ²	1.36		
		lb-in-s ²	1.20E-03		
Optional Brake Inertia (additional)	Jm	kgcm ²	0.36		
		lb-in-s ²	3.19E-04		
Weight (8)	W	kg	3.86		
		lb	8.5		
Static Friction (1)	Tf	Nm	0.030		
		lb-in	0.27		
Viscous Damping (1)	Kdv	Nm/krpm	0.009		
		lb-in/krpm	0.08		
Thermal Time Constant	TCT	mins.	22		
Thermal Resistance	Rthw-a	°C/W	0.725		
Pole Pairs	PP		5		
Heatsink Size			10" x 10" x 1/4" Aluminum Plate		

1. Motor winding at temp. rise, $\delta T = 100^{\circ}\text{C}$, at 40°C ambient
2. All data referenced to sinusoidal commutation
3. Add parking brake if applicable for total inertia
4. Motor with resolver feedback and standard heat sink
5. May be limited at some values of V_{bus}
6. Measured at 25°C
7. See de-rate chart for the de-rate of different motor options.
8. Brake motor adds 0.45 kg [1.0 lbs]
9. Shaft seal increases Static Friction by 0.020 Nm [0.21 lb-in]

Brake options are listed in chapter "Technical Data Brakes" from [Technical Data Brakes](#).

7.4.4.1 AKM2G-42L Derates for Different Options

Note: Derate information is for general estimation only. For the most accurate information for your motor use the online Performance Curve Generator located at pcgh.kollmorgen.com, the AKM2G Performance Curves document available for download at www.kollmorgen.com/sites/default/files/public_downloads/AKM2G%20Performance%20Curves_0.pdf, or refer to Kollmorgen's Motioneering Software Tool at www.kollmorgen.com/en-us/service-and-support/technical/motioneering-online/.

De-rates are referenced to the Max Continuous Torque ΔT wdg. = 100°C

Options - No Brake	Speed: RPM						
	0	500	1000	1500	2000	2500	2800
Resolver	100.0%	99.0%	97.4%	95.8%	94.2%	92.6%	91.6%
Resolver/Seal	99.5%	98.4%	96.5%	94.7%	92.8%	90.9%	89.8%
SFD	100.0%	99.0%	97.4%	95.8%	94.2%	92.6%	91.6%
SFD/Seal	99.5%	98.4%	96.5%	94.7%	92.8%	90.9%	89.8%
DSL	100.0%	99.0%	97.4%	95.8%	94.2%	92.6%	91.6%
DSL/Seal	99.5%	98.4%	96.5%	94.7%	92.8%	90.9%	89.8%
EnDat2.2	100.0%	99.0%	97.4%	95.8%	94.2%	92.0%	90.7%
EnDat2.2/Seal	99.5%	98.4%	96.5%	94.5%	92.0%	89.3%	87.7%

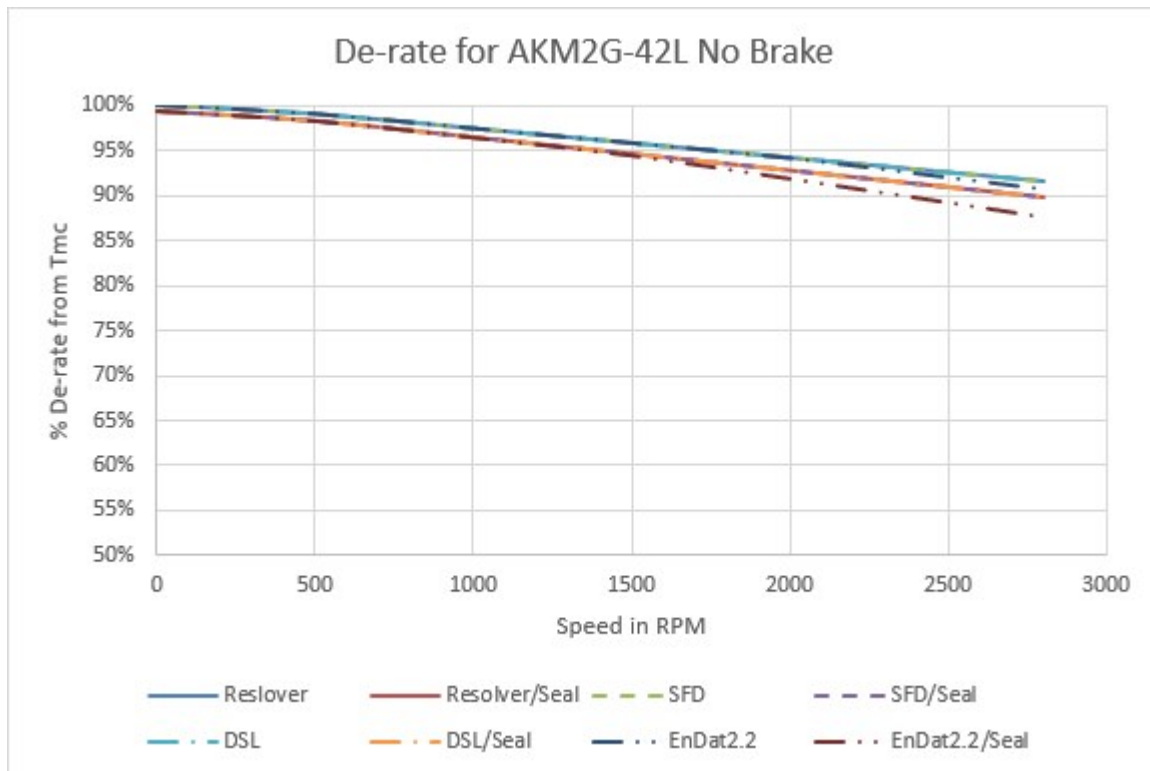

De-rates are referenced to the Max Continuous Torque ΔT wdg. = 100°C

Options - Brake	Speed: RPM						
	0	500	1000	1500	2000	2500	2800
Resolver	100.0%	99.0%	97.4%	95.8%	94.2%	92.6%	91.6%
Resolver/Seal	99.5%	98.4%	96.5%	94.7%	92.8%	90.9%	89.8%
SFD	100.0%	99.0%	97.4%	95.8%	94.2%	92.6%	91.6%
SFD/Seal	99.5%	98.4%	96.5%	94.7%	92.8%	90.9%	89.8%
DSL	100.0%	99.0%	97.4%	95.8%	94.2%	92.6%	91.6%
DSL/Seal	99.5%	98.4%	96.5%	94.7%	92.8%	90.9%	89.8%
EnDat2.2	100.0%	99.0%	97.4%	95.8%	94.0%	91.8%	90.5%
EnDat2.2/Seal	99.5%	98.4%	96.5%	94.4%	91.7%	89.0%	87.4%

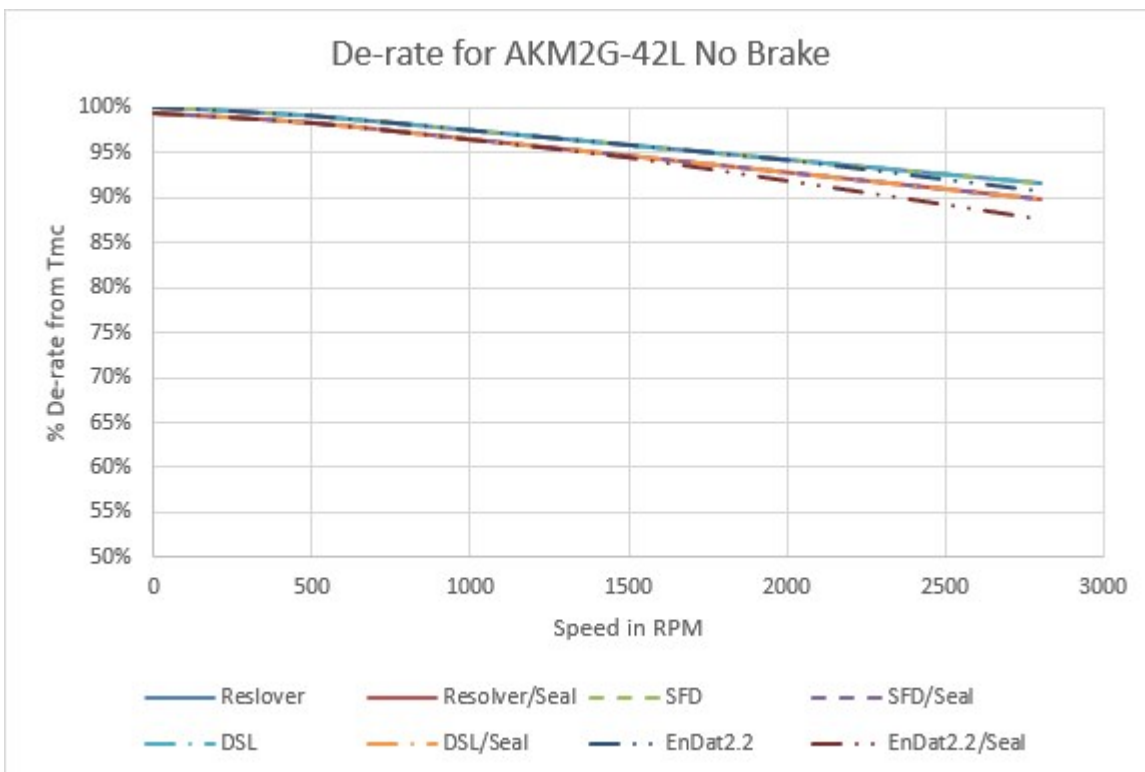

Note: For EnDat feedback motors acceleration of the motor is limited to $\leq 1 \cdot 10^5$ rad/s². The connected servo drive may further limit this value.

7.4.5 Technical Data AKM2G-43

UN	Parameter	Tolerance	Symbol	Units	AKM2G		
					43D	43G	43I
Electrical data							
	Max. Rated Equivalent Line Voltage	Max	V bus	V ac	480	480	480
	Max. Continuous Torque for ΔT winding = 100°C (1)(2)(4)	Nom	Tmc	Nm	6.97	6.97	6.98
				ib-in	61.7	61.7	61.8
	Max. Continuous Current for ΔT winding = 100°C (1)(2)(4)	Nom	Imc	Arms	2.33	4.52	7.14
	Max. Continuous Torque for ΔT winding = 60°C (2)(4)	Nom	Tmc	Nm	5.44	5.46	5.51
				lb-in	48.1	48.3	48.8
	Max. mechanical speed (5)	Nom	Nmax	rpm	6000	6000	6000
	Peak Torque (1)(2)(4)	Nom	Tp	Nm	21.1	21.1	21.1
				lb-in	187	187	187
	Peak Current	Nom	Ip	Arms	9.31	18.1	28.6
120 V AC	Rated Torque (speed) (1)(2)(4)		Trtd	Nm			6.81
				lb-in			60.3
	Rated Speed		Nrtd	rpm			1400
	Rated Power (speed) (1)(2)(4)		Prtd	kW			1.00
Hp						1.34	
240 V AC	Rated Torque (speed) (1)(2)(4)		Trtd	Nm		6.61	6.21
				lb-in		58.5	55.0
	Rated Speed		Nrtd	rpm		1900	3000
	Rated Power (speed) (1)(2)(4)		Prtd	kW		1.32	1.95
Hp					1.76	2.62	
400 V AC	Rated Torque (speed) (1)(2)(4)		Trtd	Nm	6.67	6.10	4.83
				lb-in	59.0	54.0	42.7
	Rated Speed		Nrtd	rpm	1600	3200	5300
	Rated Power (speed) (1)(2)(4)		Prtd	kW	1.12	2.05	2.68
Hp				1.50	2.74	3.59	
480 V AC	Rated Torque (speed) (1)(2)(4)		Trtd	Nm	6.58	5.76	4.02
				lb-in	58.2	51.0	35.6
	Rated Speed		Nrtd	rpm	1900	3900	6000
	Rated Power (speed) (1)(2)(4)		Prtd	kW	1.31	2.35	2.53
Hp				1.75	3.15	3.39	

UN	Parameter	Tolerance	Symbol	Units	AKM2G		
					43D	43G	43I
	Torque Constant (1)	+/- 10%	Kt	Nm/Arms	3.01	1.55	0.983
				lb-in/Arms	26.7	13.7	8.7
	Back EMF Constant (6)	+/- 10%	Ke	Vrms/krpm	202	104	65.9
	Motor Constant (1)	Nom	Km	Nm/ \sqrt{W}	0.678	0.681	0.687
				lb-in/ \sqrt{W}	6.00	6.03	6.08
	Resistance (line-line) (6)	+/- 10%	Rm	Ω	13.2	3.46	1.36
	Inductance Q-Axis (line-line)		Lqll	mH	95.5	25.3	10.2
	Inductance D-Axis (line-line)		Ldll	mH	TBD	TBD	TBD
	Inductance Saturation Current		Lisat	Arms	15.0	29.1	45.9
Maximum Demagnetization Current		Midpeak	Arms	TBD	TBD	TBD	

Parameter	Symbol	Units	AKM2G		
			43D	43G	43I
Mechanical Data					
Inertia (incl. Resolver feedback) (3)	Jm	kgcm ²	1.95		
		lb-in-s ²	1.72E-03		
Optional Brake Inertia (additional)	Jm	kgcm ²	0.36		
		lb-in-s ²	3.19E-04		
Weight (8)	W	kg	4.81		
		lb	10.6		
Static Friction (1)	Tf	Nm	0.0380		
		lb-in	0.336		
Viscous Damping (1)	Kdv	Nm/krpm	0.0125		
		lb-in/krpm	0.111		
Thermal Time Constant	TCT	mins.	27		
Thermal Resistance	Rthw-a	°C/W	0.637		
Pole Pairs	PP		5		
Heatsink Size			10" x 10" x 1/4" Aluminum Plate		

1. Motor winding at temp. rise, $\delta T = 100^{\circ}\text{C}$, at 40°C ambient
2. All data referenced to sinusoidal commutation
3. Add parking brake if applicable for total inertia
4. Motor with resolver feedback and standard heat sink
5. May be limited at some values of V_{bus}
6. Measured at 25°C
7. See de-rate chart for the de-rate of different motor options.
8. Brake motor adds 1.36 kg [3.0 lbs]
9. Shaft seal increases Static Friction by 0.023 Nm [0.20 lb-in]

Brake options are listed in chapter "Technical Data Brakes" from [Technical Data Brakes](#).

7.4.5.1 AKM2G-43 Derates for Different Options

Note: Derate information is for general estimation only. For the most accurate information for your motor use the online Performance Curve Generator located at pcgh.kollmorgen.com, the AKM2G Performance Curves document available for download at www.kollmorgen.com/sites/default/files/public_downloads/AKM2G%20Performance%20Curves_0.pdf, or refer to Kollmorgen's Motioneering Software Tool at www.kollmorgen.com/en-us/service-and-support/technical/motioneering-online/.

De-rates are referenced to the Max Continuous Torque ΔT wdg. = 100°C

Options - No Brake	Speed: RPM						
	0	1000	2000	3000	4000	5000	6000
Resolver	100.0%	94.6%	87.7%	80.7%	73.4%	65.8%	57.7%
Resolver/Seal	99.6%	93.7%	86.3%	78.6%	70.6%	62.0%	52.7%
SFD	100.0%	94.6%	87.7%	79.4%	70.5%	60.6%	49.6%
SFD/Seal	99.6%	93.7%	85.9%	76.4%	66.0%	54.2%	40.1%
DSL	100.0%	94.6%	87.7%	79.4%	70.5%	60.6%	49.6%
DSL/Seal	99.6%	93.7%	85.9%	76.4%	66.0%	54.2%	40.1%
EnDat2.2	96.9%	90.2%	81.4%	71.9%	61.6%	49.8%	
EnDat2.2/Seal	96.5%	89.1%	79.2%	68.5%	56.3%	41.6%	

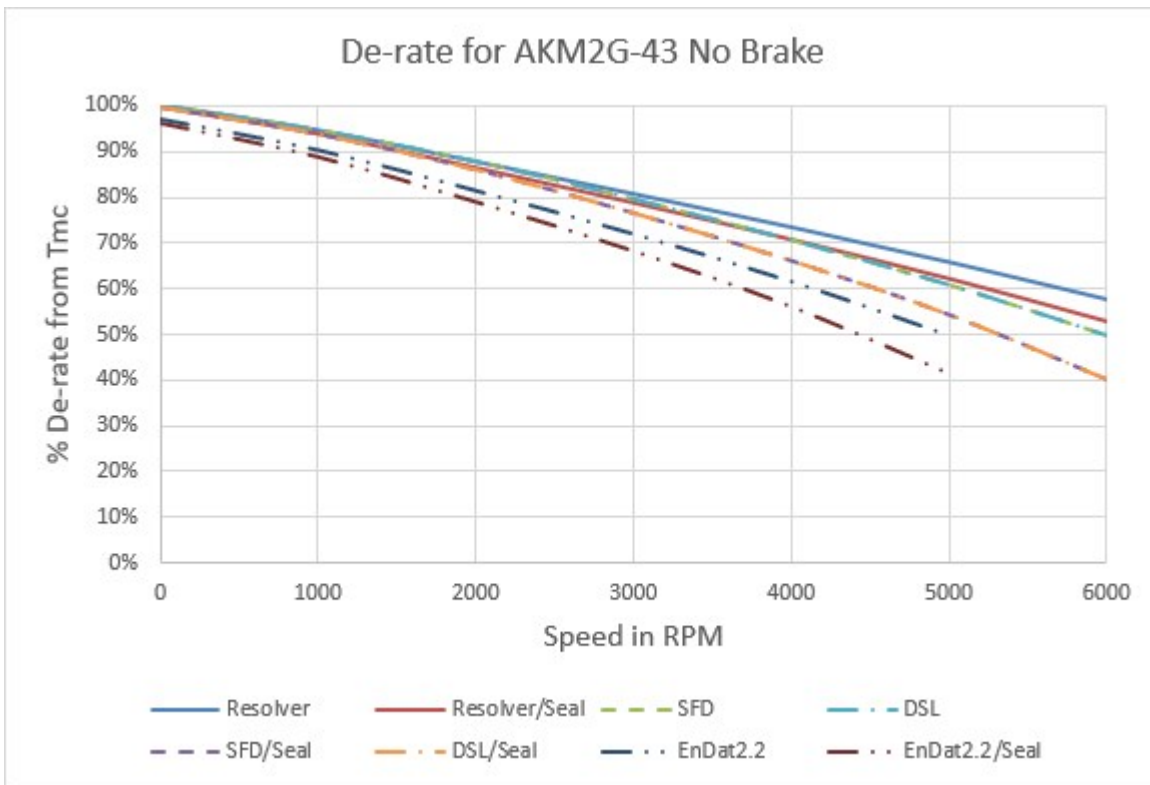

De-rates are referenced to the Max Continuous Torque ΔT wdg. = 100°C

Options - Brake	Speed: RPM						
	0	1000	2000	3000	4000	5000	6000
Resolver	100.0%	94.6%	87.7%	79.4%	70.5%	60.6%	49.6%
Resolver/Seal	99.6%	93.7%	85.9%	76.4%	66.0%	54.2%	40.1%
SFD	100.0%	94.6%	87.7%	79.4%	70.5%	60.6%	49.4%
SFD/Seal	99.6%	93.7%	85.9%	76.4%	66.0%	54.1%	39.7%
DSL	100.0%	94.6%	87.7%	79.4%	70.5%	60.6%	49.4%
DSL/Seal	99.6%	93.7%	85.9%	76.4%	66.0%	54.1%	39.7%
EnDat2.2	96.9%	90.2%	81.4%	71.9%	61.6%	49.8%	
EnDat2.2/Seal	96.5%	89.1%	79.2%	68.5%	56.3%	41.6%	

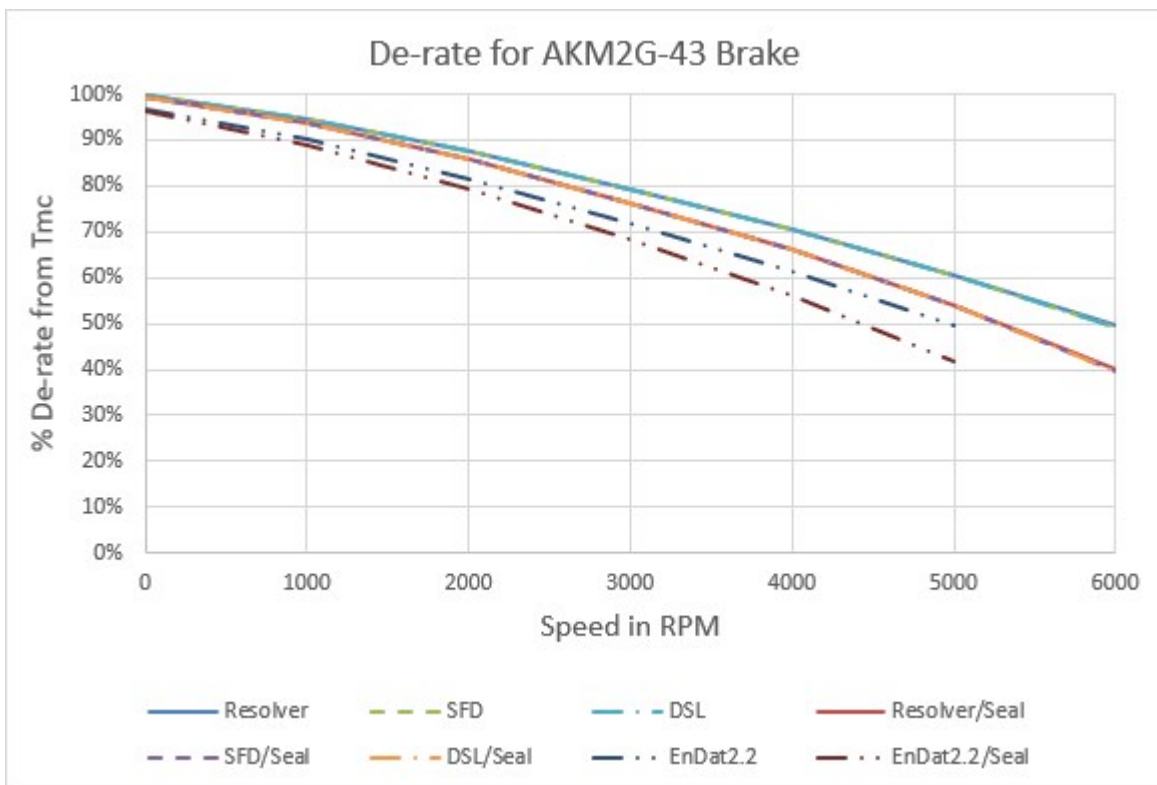

Note: For EnDat feedback motors acceleration of the motor is limited to $\leq 1 \cdot 10^5$ rad/s². The connected servo drive may further limit this value.

7.4.6 Technical Data AKM2G-43L

UN	Parameter	Tolerance	Symbol	Units	AKM2G		
					LL	ML	NL
Electrical data							
	Max. Rated DC Bus Voltage	Max	V bus	V dc	170	170	170
	Max. Continuous Torque for ΔT winding = 100°C (1)(2)(4)	Nom	Tmc	Nm	7.07	7.06	7.06
				ib-in	62.6	62.5	62.5
	Max. Continuous Current for ΔT winding = 100°C (1)(2)(4)	Nom	Imc	Arms	12.5	14.0	18.0
	Max. Continuous Torque for ΔT winding = 60°C (2)(4)	Nom	Tmc	Nm	5.51	5.50	5.51
				lb-in	48.7	48.7	48.7
	Max. mechanical speed (5)	Nom	Nmax	rpm	6000	6000	6000
	Peak Torque (1)(2)(4)	Nom	Tp	Nm	21.2	21.2	21.2
				lb-in	188	188	188
	Peak Current	Nom	Ip	Arms	50.2	56.0	71.8
24 V DC	Rated Torque (speed) (1)(2)(4)		Trtd	Nm			7.01
				lb-in			62.0
	Rated Speed		Nrtd	rpm			600
	Rated Power (speed) (1)(2)(4)		Prtd	kW			0.440
Hp						0.590	
48 V DC	Rated Torque (speed) (1)(2)(4)		Trtd	Nm		7.00	6.96
				lb-in		62.0	61.6
	Rated Speed		Nrtd	rpm		600	800
	Rated Power (speed) (1)(2)(4)		Prtd	kW		0.440	0.58
Hp					0.59	0.78	
72 V DC	Rated Torque (speed) (1)(2)(4)		Trtd	Nm	6.94	6.91	6.83
				lb-in	61.4	61.1	60.4
	Rated Speed		Nrtd	rpm	900	1000	1300
	Rated Power (speed) (1)(2)(4)		Prtd	kW	0.654	0.724	0.93
Hp				0.88	0.97	1.25	
96 V DC	Rated Torque (speed) (1)(2)(4)		Trtd	Nm	6.86	6.80	6.65
				lb-in	60.7	60.2	58.8
	Rated Speed		Nrtd	rpm	1200	1400	1900
	Rated Power (speed) (1)(2)(4)		Prtd	kW	0.86	1.00	1.32
Hp				1.16	1.34	1.77	

UN	Parameter	Tolerance	Symbol	Units	AKM2G		
					LL	ML	NL
	Torque Constant (1)	+/- 10%	Kt	Nm/Arms	0.567	0.507	0.395
				lb-in/Arms	5.02	4.49	3.50
	Back EMF Constant (6)	+/- 10%	Ke	Vrms/krpm	38.0	34.0	26.5
	Motor Constant (1)	Nom	Km	Nm/√W	0.687	0.686	0.687
				lb-in/√W	6.08	6.07	6.08
	Resistance (line-line) (6)	+/- 10%	Rm	Ω	0.454	0.364	0.221
	Inductance Q-Axis (line-line)		Lqll	mH	3.4	2.7	1.6
	Inductance D-Axis (line-line)		Ldll	mH	TBD	TBD	TBD
	Inductance Saturation Current		Lisat	Arms	80	89	114
	Maximum Demagnetization Current		Midpeak	Arms	TBD	TBD	TBD

Parameter	Symbol	Units	AKM2G			
			LL	ML	NL	S1L
Mechanical Data						
Inertia (incl. Resolver feedback) (3)	Jm	kgcm ²	1.95			
		lb-in-s ²	1.72E-03			
Optional Brake Inertia (additional)	Jm	kgcm ²	0.36			
		lb-in-s ²	3.19E-04			
Weight (8)	W	kg	4.81			
		lb	10.6			
Static Friction (1)	Tf	Nm	0.0380			
		lb-in	0.336			
Viscous Damping (1)	Kdv	Nm/krpm	0.0125			
		lb-in/krpm	0.111			
Thermal Time Constant	TCT	mins.	27			
Thermal Resistance	Rthw-a	°C/W	0.637			
Pole Pairs	PP		5			
Heatsink Size			10" x 10" x 1/4" Aluminum Plate			

1. Motor winding at temp. rise, $\delta T = 100^{\circ}\text{C}$, at 40°C ambient
2. All data referenced to sinusoidal commutation
3. Add parking brake if applicable for total inertia
4. Motor with resolver feedback and standard heat sink
5. May be limited at some values of V_{bus}
6. Measured at 25°C
7. See de-rate chart for the de-rate of different motor options.
8. Brake motor adds 1.36 kg [3.0 lbs]
9. Shaft seal increases Static Friction by 0.023 Nm [0.20 lb-in]

Brake options are listed in chapter "Technical Data Brakes" from [Technical Data Brakes](#).

7.4.6.1 AKM2G-43L Derates for Different Options

Note: Derate information is for general estimation only. For the most accurate information for your motor use the online Performance Curve Generator located at pcgh.kollmorgen.com, the AKM2G Performance Curves document available for download at www.kollmorgen.com/sites/default/files/public_downloads/AKM2G%20Performance%20Curves_0.pdf, or refer to Kollmorgen's Motioneering Software Tool at www.kollmorgen.com/en-us/service-and-support/technical/motioneering-online/.

De-rates are referenced to the Max Continuous Torque ΔT wdg. = 100°C

Options - No Brake	Speed: RPM							
	0	600	800	1000	1200	1400	1800	2400
Resolver	100.0%	98.5%	97.7%	97.0%	96.2%	95.5%	93.9%	91.6%
Resolver/Seal	99.6%	97.8%	97.0%	96.2%	95.3%	94.5%	92.7%	90.1%
SFD	100.0%	98.5%	97.7%	97.0%	96.2%	95.5%	93.9%	91.6%
SFD/Seal	99.6%	97.8%	97.0%	96.2%	95.3%	94.5%	92.7%	90.1%
DSL	100.0%	98.5%	97.7%	97.0%	96.2%	95.5%	93.9%	91.6%
DSL/Seal	99.6%	97.8%	97.0%	96.2%	95.3%	94.5%	92.7%	90.1%
EnDat2.2	97.1%	95.2%	94.3%	93.3%	92.4%	91.4%	89.4%	86.4%
EnDat2.2/Seal	96.7%	94.4%	93.4%	92.3%	91.1%	90.0%	87.7%	84.1%

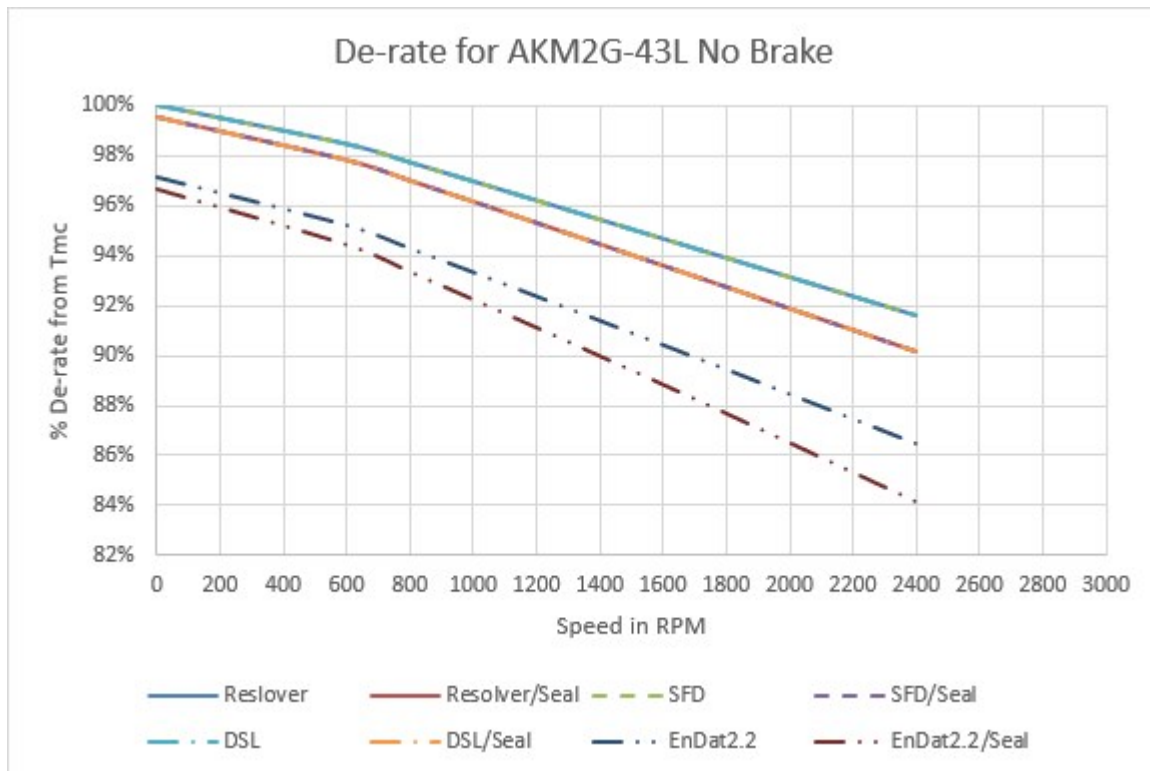

De-rates are referenced to the Max Continuous Torque ΔT wdg. = 100°C

Options - Brake	Speed: RPM							
	0	600	800	1000	1200	1400	1800	2400
Resolver	100.0%	98.5%	97.7%	97.0%	96.2%	95.5%	93.9%	91.6%
Resolver/Seal	99.6%	97.8%	97.0%	96.2%	95.3%	94.5%	92.7%	90.1%
SFD	100.0%	98.5%	97.7%	97.0%	96.2%	95.5%	93.9%	91.6%
SFD/Seal	99.6%	97.8%	97.0%	96.2%	95.3%	94.5%	92.7%	90.1%
DSL	100.0%	98.5%	97.7%	97.0%	96.2%	95.5%	93.9%	91.6%
DSL/Seal	99.6%	97.8%	97.0%	96.2%	95.3%	94.5%	92.7%	90.1%
EnDat2.2	97.1%	95.1%	94.2%	93.2%	92.2%	91.2%	89.2%	86.2%
EnDat2.2/Seal	96.6%	94.3%	93.2%	92.1%	91.0%	89.8%	87.5%	83.9%

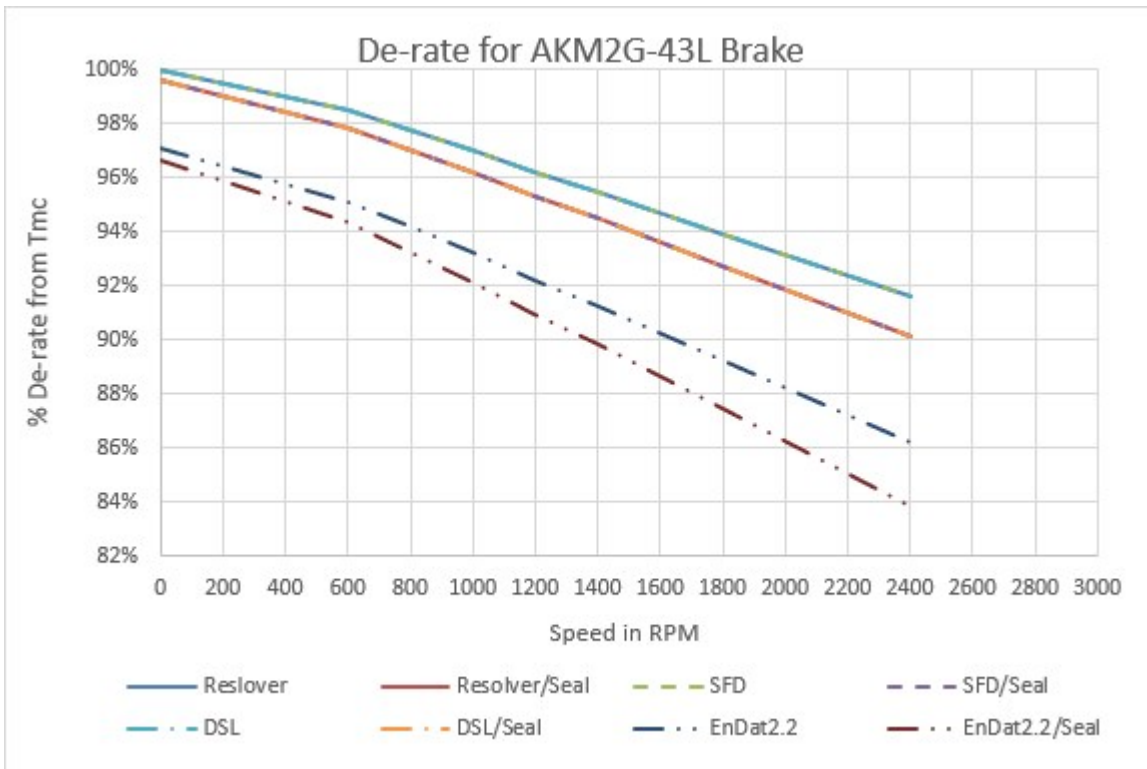

Note: For EnDat feedback motors acceleration of the motor is limited to $\leq 1 \cdot 10^5$ rad/s². The connected servo drive may further limit this value.

7.4.7 Technical Data AKM2G-44

UN	Parameter	Tolerance	Symbol	Units	AKM2G		
					44E	44H	44J
Electrical data							
	Max. Rated Equivalent Line Voltage	Max	V bus	V ac	480	480	480
	Max. Continuous Torque for ΔT winding = 100°C (1)(2)(4)	Nom	Tmc	Nm	8.48	8.51	8.47
				ib-in	75.0	75.3	75.0
	Max. Continuous Current for ΔT winding = 100°C (1)(2)(4)	Nom	Imc	Arms	2.99	5.87	7.30
	Max. Continuous Torque for ΔT winding = 60°C (2)(4)	Nom	Tmc	Nm	6.63	6.69	6.70
				lb-in	58.6	59.2	59.3
	Max. mechanical speed (5)	Nom	Nmax	rpm	6000	6000	6000
	Peak Torque (1)(2)(4)	Nom	Tp	Nm	26.9	27.0	26.9
				lb-in	238	239	238
	Peak Current	Nom	Ip	Arms	11.97	23.5	29.2
120 V AC	Rated Torque (speed) (1)(2)(4)		Trtd	Nm		8.39	8.28
				lb-in		74.2	73.3
	Rated Speed		Nrtd	rpm		900	1200
	Rated Power (speed) (1)(2)(4)		Prtd	kW		0.79	1.04
Hp					1.06	1.40	
240 V AC	Rated Torque (speed) (1)(2)(4)		Trtd	Nm	8.31	7.92	7.58
				lb-in	73.5	70.1	67.0
	Rated Speed		Nrtd	rpm	900	2000	2600
	Rated Power (speed) (1)(2)(4)		Prtd	kW	0.783	1.66	2.06
Hp				1.05	2.22	2.77	
400 V AC	Rated Torque (speed) (1)(2)(4)		Trtd	Nm	7.99	6.98	6.04
				lb-in	70.7	61.8	53.4
	Rated Speed		Nrtd	rpm	1700	3500	4500
	Rated Power (speed) (1)(2)(4)		Prtd	kW	1.42	2.56	2.84
Hp				1.91	3.43	3.81	
480 V AC	Rated Torque (speed) (1)(2)(4)		Trtd	Nm	7.80	6.32	4.92
				lb-in	69.1	56.0	43.6
	Rated Speed		Nrtd	rpm	2100	4300	5400
	Rated Power (speed) (1)(2)(4)		Prtd	kW	1.72	2.85	2.78
Hp				2.30	3.82	3.73	

UN	Parameter	Tolerance	Symbol	Units	AKM2G		
					44E	44H	44J
	Torque Constant (1)	+/- 10%	Kt	Nm/Arms	2.85	1.46	1.17
				lb-in/Arms	25.2	12.9	10.3
	Back EMF Constant (6)	+/- 10%	Ke	Vrms/krpm	192	98.5	78.8
	Motor Constant (1)	Nom	Km	Nm/ \sqrt{W}	0.800	0.808	0.809
				lb-in/ \sqrt{W}	7.08	7.15	7.16
	Resistance (line-line) (6)	+/- 10%	Rm	Ω	8.45	2.18	1.39
	Inductance Q-Axis (line-line)		Lqll	mH	63.6	16.7	10.7
	Inductance D-Axis (line-line)		Ldll	mH	TBD	TBD	TBD
	Inductance Saturation Current		Lisat	Arms	21.0	41.0	51.3
	Maximum Demagnetization Current		Midpeak	Arms	TBD	TBD	TBD

Parameter	Symbol	Units	AKM2G		
			44E	44H	44J
Mechanical Data					
Inertia (incl. Resolver feedback) (3)	Jm	kgcm ²	2.53		
		lb-in-s ²	2.24E-03		
Optional Brake Inertia (additional)	Jm	kgcm ²	0.360		
		lb-in-s ²	3.19E-04		
Weight (8)	W	kg	5.76		
		lb	12.7		
Static Friction (1)	Tf	Nm	0.0450		
		lb-in	0.398		
Viscous Damping (1)	Kdv	Nm/krpm	0.0163		
		lb-in/krpm	0.144		
Thermal Time Constant	TCT	mins.	32		
Thermal Resistance	Rthw-a	°C/W	0.598		
Pole Pairs	PP		5		
Heatsink Size			10" x 10" x 1/4" Aluminum Plate		

1. Motor winding at temp. rise, $\delta T = 100^{\circ}\text{C}$, at 40°C ambient
2. All data referenced to sinusoidal commutation
3. Add parking brake if applicable for total inertia
4. Motor with resolver feedback and standard heat sink
5. May be limited at some values of V_{bus}
6. Measured at 25°C
7. See de-rate chart for the de-rate of different motor options.
8. Brake motor adds 1.36 kg [3.0 lbs]
9. Shaft seal increases Static Friction by 0.023 Nm [0.20 lb-in]

Brake options are listed in chapter "Technical Data Brakes" from [Technical Data Brakes](#).

7.4.7.1 AKM2G-44 Derates for Different Options

Note: Derate information is for general estimation only. For the most accurate information for your motor use the online Performance Curve Generator located at pcgh.kollmorgen.com, the AKM2G Performance Curves document available for download at www.kollmorgen.com/sites/default/files/public_downloads/AKM2G%20Performance%20Curves_0.pdf, or refer to Kollmorgen's Motioneering Software Tool at www.kollmorgen.com/en-us/service-and-support/technical/motioneering-online/.

De-rates are referenced to the Max Continuous Torque ΔT wdg. = 100°C

Options - No Brake	Speed: RPM								
	0	1000	2000	3000	4000	4500	5000	5400	5900
Resolver	100.0%	93.7%	85.6%	77.3%	68.6%	64.0%	59.2%	55.2%	50.0%
Resolver/Seal	99.6%	92.9%	84.3%	75.2%	65.6%	60.4%	55.0%	50.4%	44.3%
SFD	98.0%	90.8%	81.4%	71.4%	60.4%	54.4%	47.9%	42.3%	34.4%
SFD/Seal	97.6%	89.8%	79.6%	68.4%	55.8%	48.7%	40.7%	33.5%	
DSL	98.0%	90.8%	81.4%	71.4%	60.4%	54.4%	47.9%	42.3%	34.4%
DSL/Seal	97.6%	89.8%	79.6%	68.4%	55.8%	48.7%	40.7%	33.5%	
EnDat2.2	92.9%	85.1%	74.7%	63.4%	50.4%	43.0%			
EnDat2.2/Seal	92.5%	84.0%	72.6%	59.9%	44.7%	35.6%			

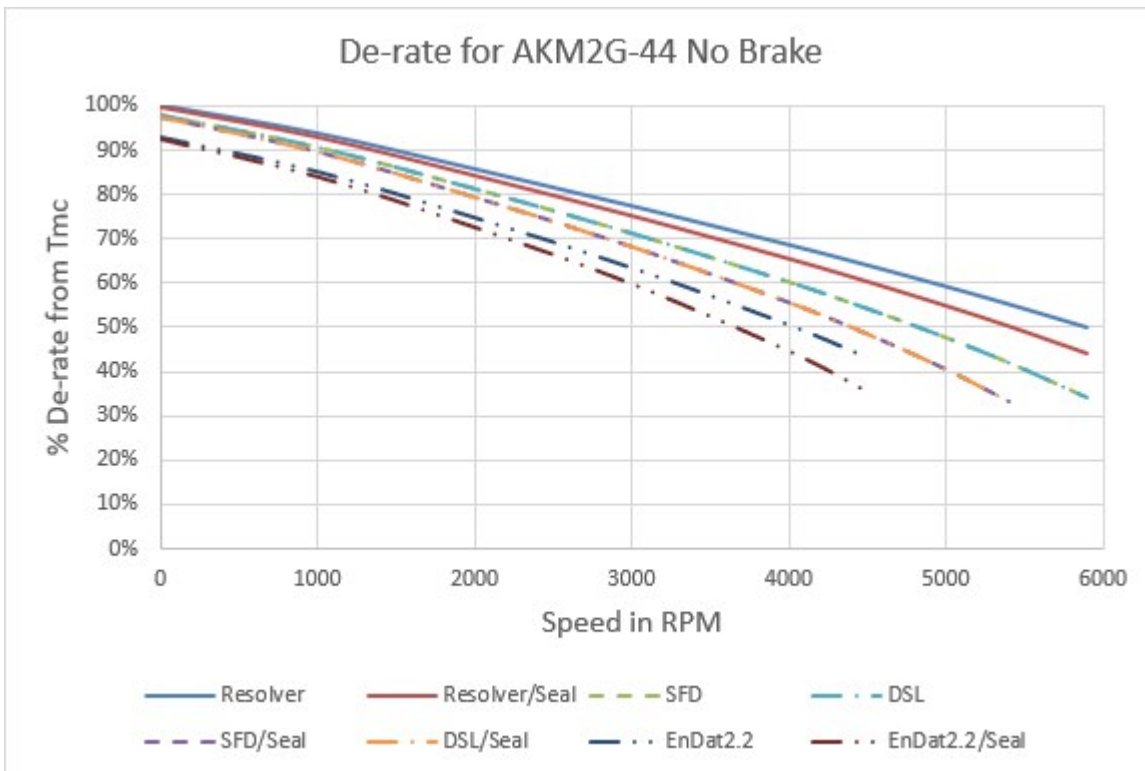

De-rates are referenced to the Max Continuous Torque ΔT wdg. = 100°C

Options - Brake	Speed: RPM								
	0	1000	2000	3000	4000	4500	5000	5400	5900
Resolver	98.3%	91.1%	81.6%	71.5%	60.5%	54.4%	47.8%	42.1%	34.1%
Resolver/Seal	97.9%	90.1%	79.8%	68.5%	55.8%	48.6%	40.5%	33.2%	22.0%
SFD	98.0%	90.8%	81.4%	71.4%	60.4%	54.4%	47.8%	42.1%	34.1%
SFD/Seal	97.6%	89.8%	79.6%	68.4%	55.8%	48.6%	40.5%	33.2%	
DSL	98.0%	90.8%	81.4%	71.4%	60.4%	54.4%	47.8%	42.1%	34.1%
DSL/Seal	97.6%	89.8%	79.6%	68.4%	55.8%	48.6%	40.5%	33.2%	
EnDat2.2	92.9%	85.1%	74.7%	63.4%	50.4%	43.0%			
EnDat2.2/Seal	92.5%	84.0%	72.6%	59.9%	44.7%	35.6%			

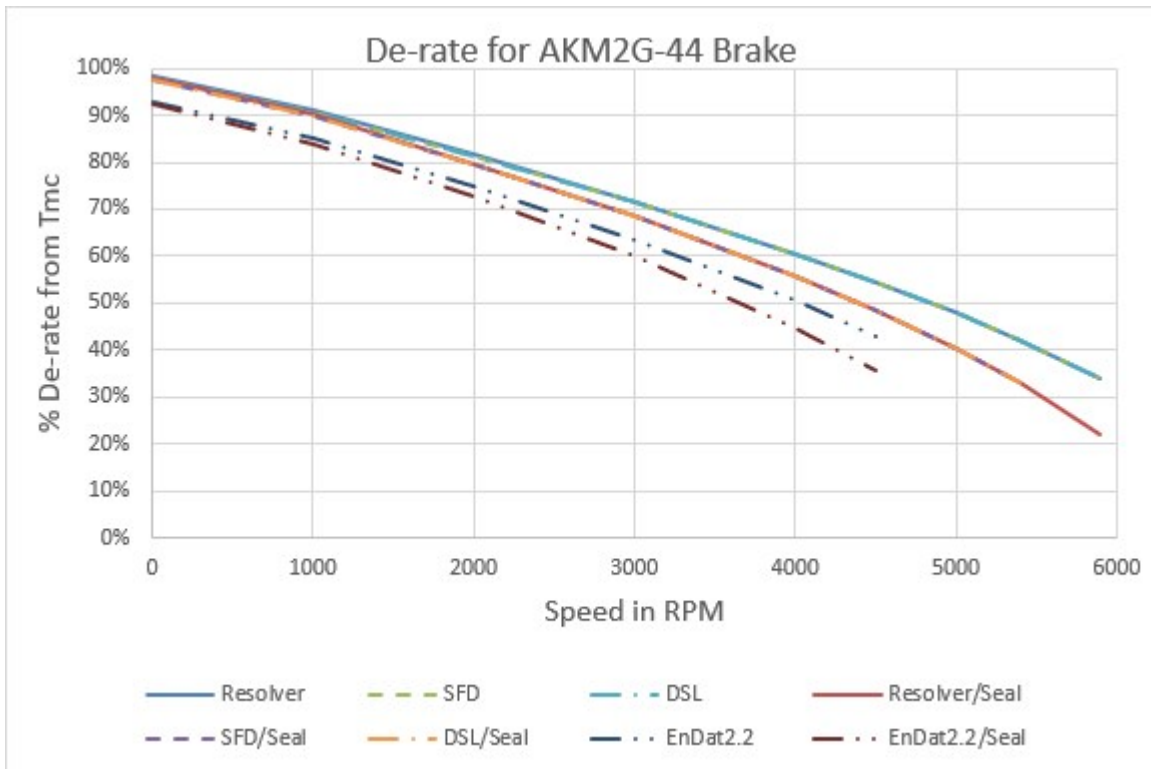

Note: For EnDat feedback motors acceleration of the motor is limited to $\leq 1 \cdot 10^5$ rad/s². The connected servo drive may further limit this value.

7.4.8 Technical Data AKM2G-44L

UN	Parameter	Tolerance	Symbol	Units	AKM2G		
					LL	ML	NL
Electrical data							
	Max. Rated DC Bus Voltage	Max	V bus	V dc	170	170	170
	Max. Continuous Torque for ΔT winding = 100°C (1)(2)(4)	Nom	Tmc	Nm	8.59	8.60	8.59
				ib-in	76.0	76.1	76.0
	Max. Continuous Current for ΔT winding = 100°C (1)(2)(4)	Nom	Imc	Arms	12.8	14.5	16.4
	Max. Continuous Torque for ΔT winding = 60°C (2)(4)	Nom	Tmc	Nm	6.70	6.71	6.70
				lb-in	59.3	59.4	59.3
	Max. mechanical speed (5)	Nom	Nmax	rpm	6000	6000	6000
	Peak Torque (1)(2)(4)	Nom	Tp	Nm	27.1	27.1	27.1
				lb-in	240	240	240
	Peak Current	Nom	Ip	Arms	51.3	58.2	65.7
24 V DC	Rated Torque (speed) (1)(2)(4)		Trtd	Nm		8.54	8.50
				lb-in		75.6	75.2
	Rated Speed		Nrtd	rpm		500	600
	Rated Power (speed) (1)(2)(4)		Prtd	kW		0.447	0.534
Hp					0.600	0.716	
48 V DC	Rated Torque (speed) (1)(2)(4)		Trtd	Nm	8.46	8.41	8.36
				lb-in	74.9	74.4	74.0
	Rated Speed		Nrtd	rpm	700	900	1000
	Rated Power (speed) (1)(2)(4)		Prtd	kW	0.620	0.793	0.875
Hp				0.832	1.06	1.17	
72 V DC	Rated Torque (speed) (1)(2)(4)		Trtd	Nm	8.35	8.29	8.20
				lb-in	73.9	73.4	72.5
	Rated Speed		Nrtd	rpm	1000	1200	1400
	Rated Power (speed) (1)(2)(4)		Prtd	kW	0.874	1.04	1.20
Hp				1.17	1.40	1.61	
96 V DC	Rated Torque (speed) (1)(2)(4)		Trtd	Nm	8.28	8.21	8.11
				lb-in	73.2	72.6	71.7
	Rated Speed		Nrtd	rpm	1200	1400	1600
	Rated Power (speed) (1)(2)(4)		Prtd	kW	1.040	1.20	1.36
Hp				1.39	1.61	1.82	

UN	Parameter	Tolerance	Symbol	Units	AKM2G		
					LL	ML	NL
	Torque Constant (1)	+/- 10%	Kt	Nm/Arms	0.674	0.595	0.525
				lb-in/Arms	5.97	5.26	4.65
	Back EMF Constant (6)	+/- 10%	Ke	Vrms/krpm	45.5	40.1	35.5
	Motor Constant (1)	Nom	Km	Nm/ \sqrt{W}	0.809	0.810	0.809
				lb-in/ \sqrt{W}	7.16	7.17	7.16
	Resistance (line-line) (6)	+/- 10%	Rm	Ω	0.463	0.359	0.281
	Inductance Q-Axis (line-line)		Lqll	mH	3.6	2.8	2.2
	Inductance D-Axis (line-line)		Ldll	mH	TBD	TBD	TBD
	Inductance Saturation Current		Lisat	Arms	89	101	114
	Maximum Demagnetization Current		Midpeak	Arms	TBD	TBD	TBD

Parameter	Symbol	Units	AKM2G		
			LL	ML	NL
Mechanical Data					
Inertia (incl. Resolver feedback) (3)	Jm	kgcm ²	2.53		
		lb-in-s ²	2.24E-03		
Optional Brake Inertia (additional)	Jm	kgcm ²	0.360		
		lb-in-s ²	3.19E-04		
Weight (8)	W	kg	5.76		
		lb	12.7		
Static Friction (1)	Tf	Nm	0.0450		
		lb-in	0.398		
Viscous Damping (1)	Kdv	Nm/krpm	0.0163		
		lb-in/krpm	0.144		
Thermal Time Constant	TCT	mins.	32		
Thermal Resistance	Rthw-a	°C/W	0.598		
Pole Pairs	PP		5		
Heatsink Size			10" x 10" x 1/4" Aluminum Plate		

1. Motor winding at temp. rise, $\delta T = 100^{\circ}\text{C}$, at 40°C ambient
2. All data referenced to sinusoidal commutation
3. Add parking brake if applicable for total inertia
4. Motor with resolver feedback and standard heat sink
5. May be limited at some values of V_{bus}
6. Measured at 25°C
7. See de-rate chart for the de-rate of different motor options.
8. Brake motor adds 1.36 kg [3.0 lbs]
9. Shaft seal increases Static Friction by 0.023 Nm [0.20 lb-in]

Brake options are listed in chapter "Technical Data Brakes" from [Technical Data Brakes](#).

7.4.8.1 AKM2G-44L Derates for Different Options

Note: Derate information is for general estimation only. For the most accurate information for your motor use the online Performance Curve Generator located at pcgh.kollmorgen.com, the AKM2G Performance Curves document available for download at www.kollmorgen.com/sites/default/files/public_downloads/AKM2G%20Performance%20Curves_0.pdf, or refer to Kollmorgen's Motioneering Software Tool at www.kollmorgen.com/en-us/service-and-support/technical/motioneering-online/.

De-rates are referenced to the Max Continuous Torque ΔT wdg. = 100°C

Options - No Brake	Speed: RPM						
	0	600	800	1000	1200	1400	1600
Resolver	100.0%	98.4%	97.6%	96.8%	96.1%	95.3%	94.5%
Resolver/Seal	99.6%	97.8%	97.0%	96.1%	95.2%	94.3%	93.4%
SFD	98.1%	96.3%	95.4%	94.5%	93.6%	92.6%	91.7%
SFD/Seal	97.7%	95.6%	94.6%	93.6%	92.5%	91.4%	90.3%
DSL	98.1%	96.3%	95.4%	94.5%	93.6%	92.6%	91.7%
DSL/Seal	97.7%	95.6%	94.6%	93.6%	92.5%	91.4%	90.3%
EnDat2.2	93.2%	91.2%	90.2%	89.2%	88.2%	87.2%	86.2%
EnDat2.2/Seal	92.8%	90.5%	89.4%	88.2%	87.0%	85.9%	84.7%

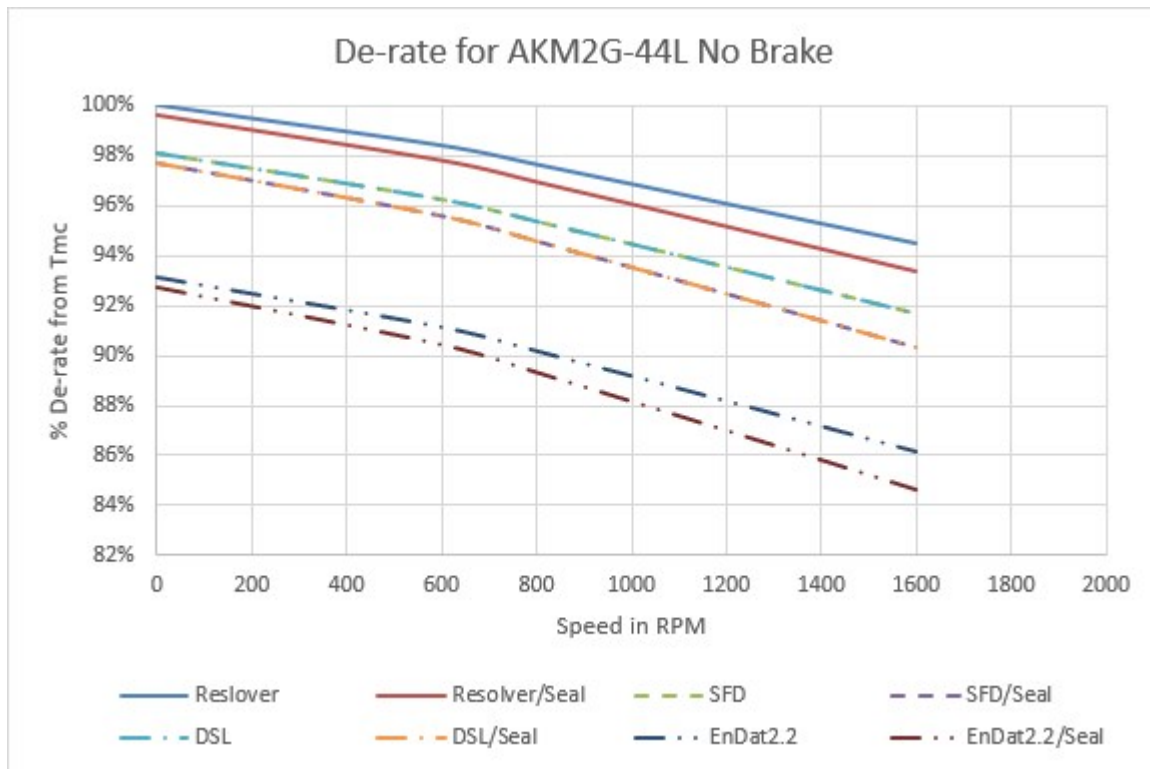

De-rates are referenced to the Max Continuous Torque ΔT wdg. = 100°C

Options - Brake	Speed: RPM						
	0	600	800	1000	1200	1400	1600
Resolver	98.5%	96.6%	95.7%	94.8%	93.9%	92.9%	92.0%
Resolver/Seal	98.1%	95.9%	94.9%	93.9%	92.8%	91.7%	90.6%
SFD	98.1%	96.3%	95.4%	94.5%	93.6%	92.6%	91.7%
SFD/Seal	97.7%	95.6%	94.6%	93.6%	92.5%	91.4%	90.3%
DSL	98.1%	96.3%	95.4%	94.5%	93.6%	92.6%	91.7%
DSL/Seal	97.7%	95.6%	94.6%	93.6%	92.5%	91.4%	90.3%
EnDat2.2	93.1%	91.0%	90.1%	89.0%	88.0%	87.0%	86.0%
EnDat2.2/Seal	92.7%	90.3%	89.2%	88.0%	86.8%	85.7%	84.4%

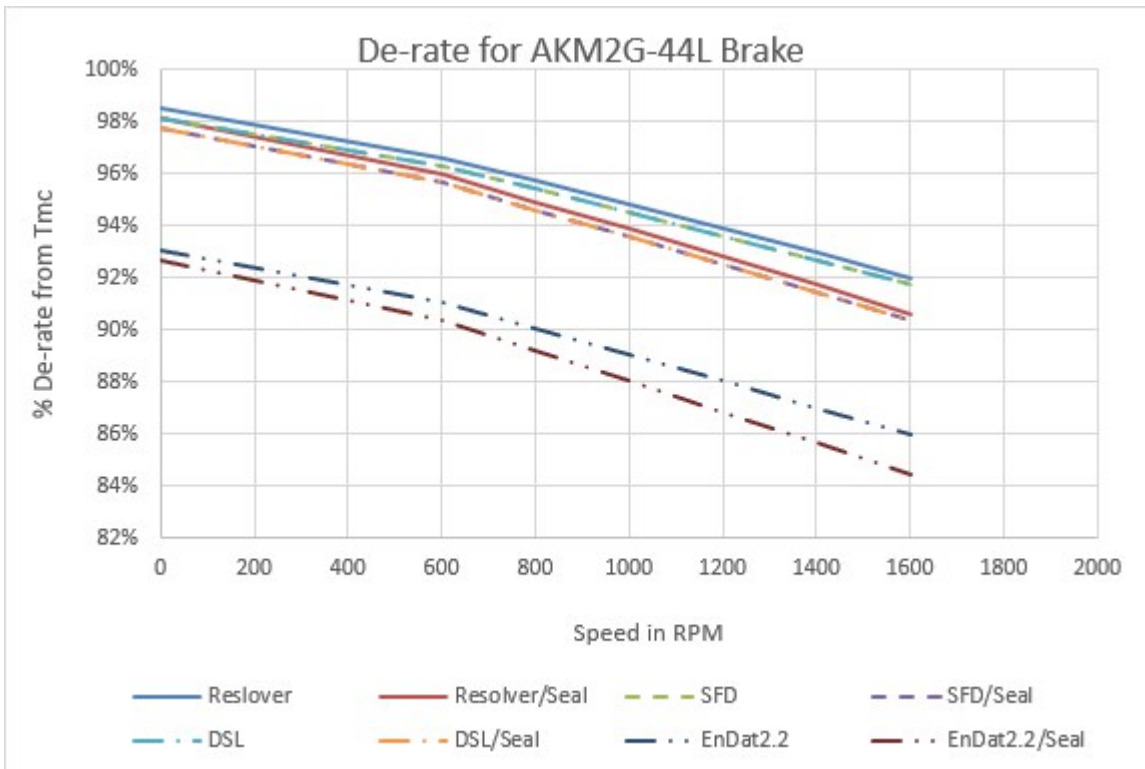

Note: For EnDat feedback motors acceleration of the motor is limited to $\leq 1 \cdot 10^5$ rad/s². The connected servo drive may further limit this value.

7.5 Technical Data AKM2G-5x Series

7.5.1 Technical Data AKM2G-51

UN	Parameter	Tolerance	Symbol	Units	AKM2G		
					51H	51I	51K
Electrical data							
	Max. Rated Equivalent Line Voltage	Max	V bus	V ac	480	480	400
	Max. Continuous Torque for ΔT winding = 100°C (1)(2)(4)	Nom	Tmc	Nm	6.82	6.83	6.81
				lb-in	60.4	60.4	60.3
	Max. Continuous Current for ΔT winding = 100°C (1)(2)(4)	Nom	Imc	Arms	5.78	6.35	10.2
	Max. Continuous Torque for ΔT winding = 60°C (2)(4)	Nom	Tmc	Nm	5.33	5.35	5.36
				lb-in	47.2	47.3	47.4
	Max. mechanical speed (5)	Nom	Nmax	rpm	6000	6000	6000
	Peak Torque (1)(2)(4)	Nom	Tp	Nm	15.7	15.7	15.7
				lb-in	139	139	139
	Peak Current	Nom	Ip	Arms	17.3	19.0	30.5
120 V AC	Rated Torque (speed) (1)(2)(4)		Trtd	Nm	6.73	6.72	6.54
				lb-in	59.6	59.5	57.9
	Rated Speed		Nrtd	rpm	1100	1200	2100
	Rated Power (speed) (1)(2)(4)		Prtd	kW	0.78	0.85	1.44
				Hp	1.04	1.13	1.93
240 V AC	Rated Torque (speed) (1)(2)(4)		Trtd	Nm	6.44	6.38	5.77
				lb-in	57.0	56.5	51.1
	Rated Speed		Nrtd	rpm	2400	2700	4500
	Rated Power (speed) (1)(2)(4)		Prtd	kW	1.62	1.80	2.72
				Hp	2.17	2.42	3.65
400 V AC	Rated Torque (speed) (1)(2)(4)		Trtd	Nm	5.89	5.74	4.67
				lb-in	52.1	50.8	41.3
	Rated Speed		Nrtd	rpm	4200	4600	6000
	Rated Power (speed) (1)(2)(4)		Prtd	kW	2.59	2.77	2.93
				Hp	3.47	3.71	3.94
480 V AC	Rated Torque (speed) (1)(2)(4)		Trtd	Nm	5.53	5.29	
				lb-in	49.0	46.8	
	Rated Speed		Nrtd	rpm	5100	5700	
	Rated Power (speed) (1)(2)(4)		Prtd	kW	2.96	3.16	
				Hp	3.96	4.24	

UN	Parameter	Tolerance	Symbol	Units	AKM2G		
					51H	51I	51K
	Torque Constant (1)	+/- 10%	Kt	Nm/Arms	1.19	1.08	0.674
				lb-in/Arms	10.5	9.57	5.96
	Back EMF Constant (6)	+/- 10%	Ke	Vrms/krpm	80.2	73.1	45.6
	Motor Constant (1)	Nom	Km	Nm/√W	0.637	0.638	0.640
				lb-in/√W	5.63	5.65	5.66
	Resistance (line-line) (6)	+/- 10%	Rm	Ω	2.31	1.91	0.740
	Inductance Q-Axis (line-line)		Lqll	mH	20.8	17.2	6.70
	Inductance D-Axis (line-line)		Ldll	mH	TBD	TBD	TBD
	Inductance Saturation Current		Lisat	Arms	65.4	71.8	115.1
Maximum Demagnetization Current		Midpeak	Arms	TBD	TBD	TBD	
UN	Parameter	Tolerance	Symbol	Units	AKM2G		
					51H	51I	51K
Mechanical Data							
	Inertia (incl. Resolver feedback) (3)		Jm	kgcm ²	2.52		
				lb-in-s ²	2.23E-03		
	Optional Brake Inertia (additional)		Jm	kgcm ²	1.20		
				lb-in-s ²	1.06E-03		
	Weight (8)		W	kg	5.13		
				lb	11.3		
	Static Friction (1)		Tf	Nm	0.0300		
				lb-in	0.266		
	Viscous Damping (1)		Kdv	Nm/krpm	0.0125		
				lb-in/krpm	0.111		
	Thermal Time Constant		TCT	mins.	25		
	Thermal Resistance		Rthw-a	°C/W	0.585		
	Pole Pairs		PP		5		
	Heatsink Size				12" x 12" x 1/2" Aluminum Plate		

1. Motor winding at temp. rise, $\delta T = 100^{\circ}\text{C}$, at 40°C ambient
2. All data referenced to sinusoidal commutation
3. Add parking brake if applicable for total inertia
4. Motor with resolver feedback and standard heat sink
5. May be limited at some values of V_{bus}
6. Measured at 25°C
7. See de-rate chart for the de-rate of different motor options.
8. Brake motor adds 2.6 kg [5.7lbs]
9. Shaft seal increases Static Friction by 0.07 Nm [0.62 lb-in]

Brake options are listed in chapter "Technical Data Brakes" from [Technical Data Brakes](#).

7.5.1.1 AKM2G-51 Derates for Different Options

Note: Derate information is for general estimation only. For the most accurate information for your motor use the online Performance Curve Generator located at pcgh.kollmorgen.com, the AKM2G Performance Curves document available for download at www.kollmorgen.com/sites/default/files/public_downloads/AKM2G%20Performance%20Curves_0.pdf, or refer to Kollmorgen's Motioneering Software Tool at www.kollmorgen.com/en-us/service-and-support/technical/motioneering-online/.

De-rates are referenced to the Max Continuous Torque ΔT wdg. = 100°C

Options - No Brake	Speed: RPM						
	0	1000	2000	3000	4000	5000	6000
Resolver	100.0%	95.5%	89.9%	84.5%	79.1%	73.8%	68.6%
Resolver/Seal	98.8%	93.4%	86.6%	79.8%	73.0%	66.0%	58.9%
SFD	100.0%	95.5%	89.9%	84.5%	79.1%	73.8%	68.6%
SFD/Seal	98.8%	93.4%	86.6%	79.8%	73.0%	65.6%	56.5%
DSL	100.0%	95.5%	89.9%	84.5%	79.1%	73.8%	68.6%
DSL/Seal	98.8%	93.4%	86.6%	79.8%	73.0%	65.6%	56.5%
EnDat2.2	100.0%	95.5%	89.9%	84.5%	79.1%	72.9%	66.5%
EnDat2.2/Seal	98.8%	93.4%	86.6%	79.4%	70.7%	61.6%	51.8%

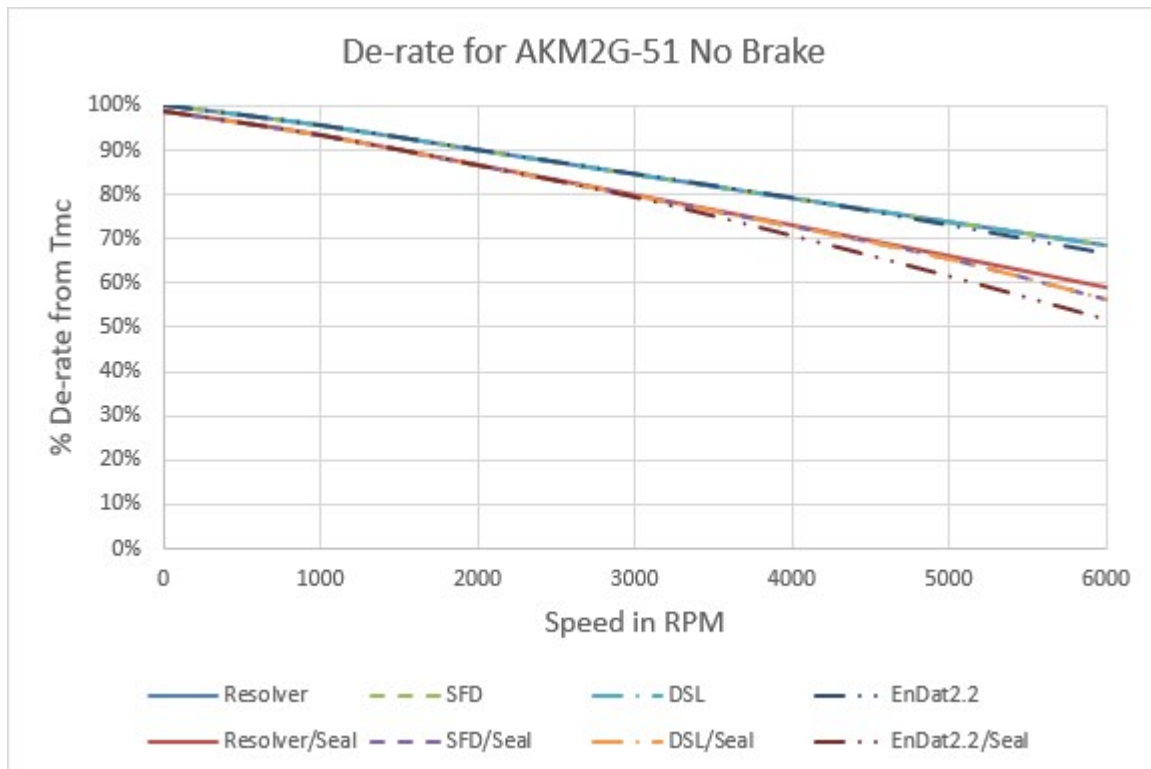

De-rates are referenced to the Max Continuous Torque ΔT wdg. = 100°C

Options - Brake	Speed: RPM						
	0	1000	2000	3000	4000	5000	6000
Resolver	98.2%	93.6%	88.0%	82.4%	77.0%	71.5%	66.2%
Resolver/Seal	96.9%	91.4%	84.6%	77.7%	70.7%	63.5%	56.2%
SFD	98.2%	93.6%	88.0%	82.4%	77.0%	71.5%	66.2%
SFD/Seal	96.9%	91.4%	84.6%	77.7%	70.7%	63.5%	54.3%
DSL	98.2%	93.6%	88.0%	82.4%	77.0%	71.5%	66.2%
DSL/Seal	96.9%	91.4%	84.6%	77.7%	70.7%	63.5%	54.3%
EnDat2.2	98.2%	93.6%	88.0%	82.4%	77.0%	71.0%	64.5%
EnDat2.2/Seal	96.9%	91.4%	84.6%	77.6%	68.7%	59.3%	49.3%

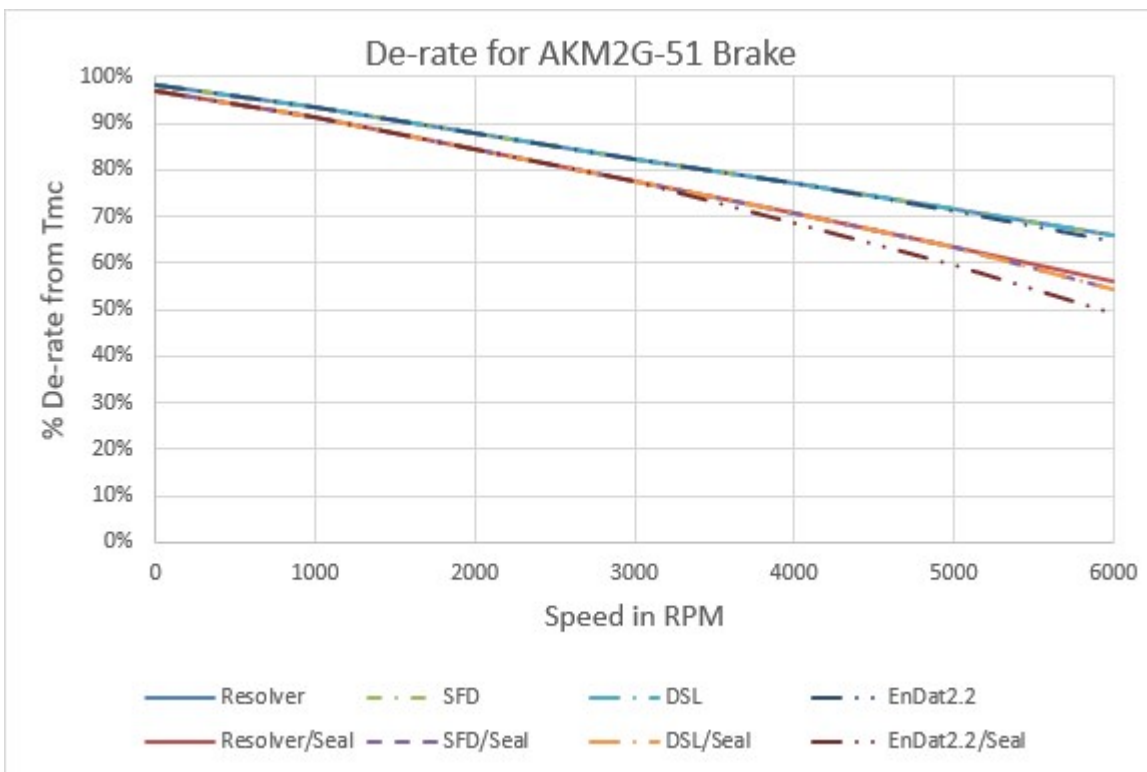

Note: For EnDat feedback motors acceleration of the motor is limited to $\leq 1 \cdot 10^5$ rad/s². The connected servo drive may further limit this value.

7.5.2 Technical Data AKM2G-52

UN	Parameter	Tolerance	Symbol	Units	AKM2G		
					52H	52K	52L
Electrical data							
	Max. Rated Equivalent Line Voltage	Max	V bus	V ac	480	480	400
	Max. Continuous Torque for ΔT winding = 100°C (1)(2)(4)	Nom	Tmc	Nm	12.0	11.9	11.93
				ib-in	106	106	106
	Max. Continuous Current for ΔT winding = 100°C (1)(2)(4)	Nom	Imc	Arms	6.30	10.0	12.5
	Max. Continuous Torque for ΔT winding = 60°C (2)(4)	Nom	Tmc	Nm	9.40	9.43	9.42
				lb-in	83.2	83.4	83.4
	Max. mechanical speed (5)	Nom	Nmax	rpm	6000	6000	6000
	Peak Torque (1)(2)(4)	Nom	Tp	Nm	29.0	29.0	28.9
				lb-in	257	256	256
	Peak Current	Nom	Ip	Arms	18.9	30.1	37.6
120 V AC	Rated Torque (speed) (1)(2)(4)		Trtd	Nm		11.7	11.5
				lb-in		103	102
	Rated Speed		Nrtd	rpm		1200	1500
	Rated Power (speed) (1)(2)(4)		Prtd	kW		1.47	1.80
Hp					1.97	2.42	
240 V AC	Rated Torque (speed) (1)(2)(4)		Trtd	Nm	11.5	10.8	10.2
				lb-in	102	95.6	90.4
	Rated Speed		Nrtd	rpm	1500	2500	3200
	Rated Power (speed) (1)(2)(4)		Prtd	kW	1.80	2.83	3.42
Hp				2.42	3.79	4.59	
400 V AC	Rated Torque (speed) (1)(2)(4)		Trtd	Nm	10.7	9.00	7.42
				lb-in	94.5	79.6	65.7
	Rated Speed		Nrtd	rpm	2700	4400	5600
	Rated Power (speed) (1)(2)(4)		Prtd	kW	3.02	4.14	4.35
Hp				4.05	5.56	5.83	
480 V AC	Rated Torque (speed) (1)(2)(4)		Trtd	Nm	10.3	7.81	
				lb-in	90.7	69.1	
	Rated Speed		Nrtd	rpm	3200	5300	
	Rated Power (speed) (1)(2)(4)		Prtd	kW	3.44	4.34	
Hp				4.61	5.82		

UN	Parameter	Tolerance	Symbol	Units	AKM2G		
					52H	52K	52L
	Torque Constant (1)	+/- 10%	Kt	Nm/Arms	1.91	1.20	0.956
				lb-in/Arms	16.9	10.6	8.46
	Back EMF Constant (6)	+/- 10%	Ke	Vrms/krpm	129	80.9	64.7
	Motor Constant (1)	Nom	Km	Nm/ \sqrt{W}	1.02	1.03	1.03
				lb-in/ \sqrt{W}	9.07	9.09	9.09
	Resistance (line-line) (6)	+/- 10%	Rm	Ω	2.32	0.902	0.578
	Inductance Q-Axis (line-line)		Lqll	mH	24.5	9.6	6.1
	Inductance D-Axis (line-line)		Ldll	mH	TBD	TBD	TBD
	Inductance Saturation Current		Lisat	Arms	81	130	163
Maximum Demagnetization Current		Midpeak	Arms	TBD	TBD	TBD	

U N	Parameter	Tolerance	Symbol	Units	AKM2G		
					52H	52K	52L
Mechanical Data							
	Inertia (incl. Resolver feedback) (3)		Jm	kgcm ²	4.58		
				lb-in-s ²	4.06E-03		
	Optional Brake Inertia (additional)		Jm	kgcm ²	1.20		
				lb-in-s ²	1.06E-03		
	Weight (8)		W	kg	7.03		
				lb	15.5		
	Static Friction (1)		Tf	Nm	0.0560		
				lb-in	0.496		
	Viscous Damping (1)		Kdv	Nm/krpm	0.0232		
				lb-in/krpm	0.205		
	Thermal Time Constant		TCT	mins.	32		
	Thermal Resistance		Rthw-a	°C/W	0.488		
	Pole Pairs		PP		5		
	Heatsink Size				12" x 12" x 1/2" Aluminum Plate		

1. Motor winding at temp. rise, $\delta T = 100^{\circ}\text{C}$, at 40°C ambient
2. All data referenced to sinusoidal commutation
3. Add parking brake if applicable for total inertia
4. Motor with resolver feedback and standard heat sink
5. May be limited at some values of V_{bus}
6. Measured at 25°C
7. See de-rate chart for the de-rate of different motor options.
8. Brake motor adds 2.6 kg [5.7 lbs]
9. Shaft seal increases Static Friction by 0.07 Nm [0.62 lb-in]

Brake options are listed in chapter "Technical Data Brakes" from [Technical Data Brakes](#).

7.5.2.1 AKM2G-52 Derates for Different Options

Note: Derate information is for general estimation only. For the most accurate information for your motor use the online Performance Curve Generator located at pcgh.kollmorgen.com, the AKM2G Performance Curves document available for download at www.kollmorgen.com/sites/default/files/public_downloads/AKM2G%20Performance%20Curves_0.pdf, or refer to Kollmorgen's Motioneering Software Tool at www.kollmorgen.com/en-us/service-and-support/technical/motioneering-online/.

De-rates are referenced to the Max Continuous Torque ΔT wdg. = 100°C

Options - No Brake	Speed: RPM						
	0	1000	2000	3000	4000	5000	5600
Resolver	100.0%	94.1%	86.8%	79.7%	72.8%	66.1%	62.2%
Resolver/Seal	99.2%	92.6%	84.2%	75.9%	67.6%	59.3%	54.4%
SFD	100.0%	94.1%	86.8%	79.7%	72.8%	65.6%	61.1%
SFD/Seal	99.2%	92.6%	84.2%	75.9%	66.3%	56.2%	49.9%
DSL	100.0%	94.1%	86.8%	79.7%	72.8%	65.6%	61.1%
DSL/Seal	99.2%	92.6%	84.2%	75.9%	66.3%	56.2%	49.9%
EnDat2.2	100.0%	94.1%	86.3%	78.0%	69.8%	61.7%	56.9%
EnDat2.2/Seal	99.2%	92.6%	82.9%	72.8%	62.4%	51.5%	44.8%

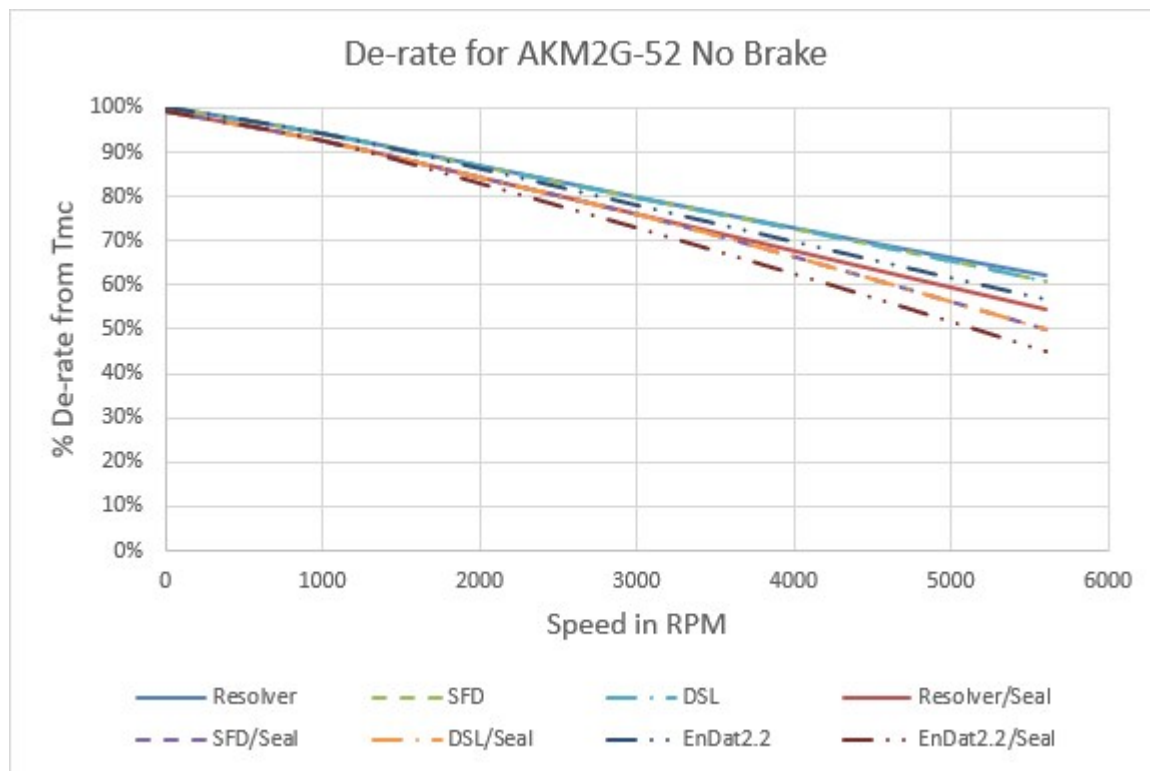

De-rates are referenced to the Max Continuous Torque ΔT wdg. = 100°C

Options - Brake	Speed: RPM						
	0	1000	2000	3000	4000	5000	5600
Resolver	98.5%	92.5%	85.1%	77.9%	70.9%	64.0%	60.0%
Resolver/Seal	97.7%	90.9%	82.5%	74.0%	65.6%	57.1%	52.1%
SFD	98.5%	92.5%	85.1%	77.9%	70.9%	64.0%	59.4%
SFD/Seal	97.7%	90.9%	82.5%	74.0%	64.7%	54.3%	48.0%
DSL	98.5%	92.5%	85.1%	77.9%	70.9%	64.0%	59.4%
DSL/Seal	97.7%	90.9%	82.5%	74.0%	64.7%	54.3%	48.0%
EnDat2.2	98.5%	92.5%	84.8%	76.5%	68.2%	59.9%	55.1%
EnDat2.2/Seal	97.7%	90.9%	81.4%	71.2%	60.6%	49.5%	42.7%

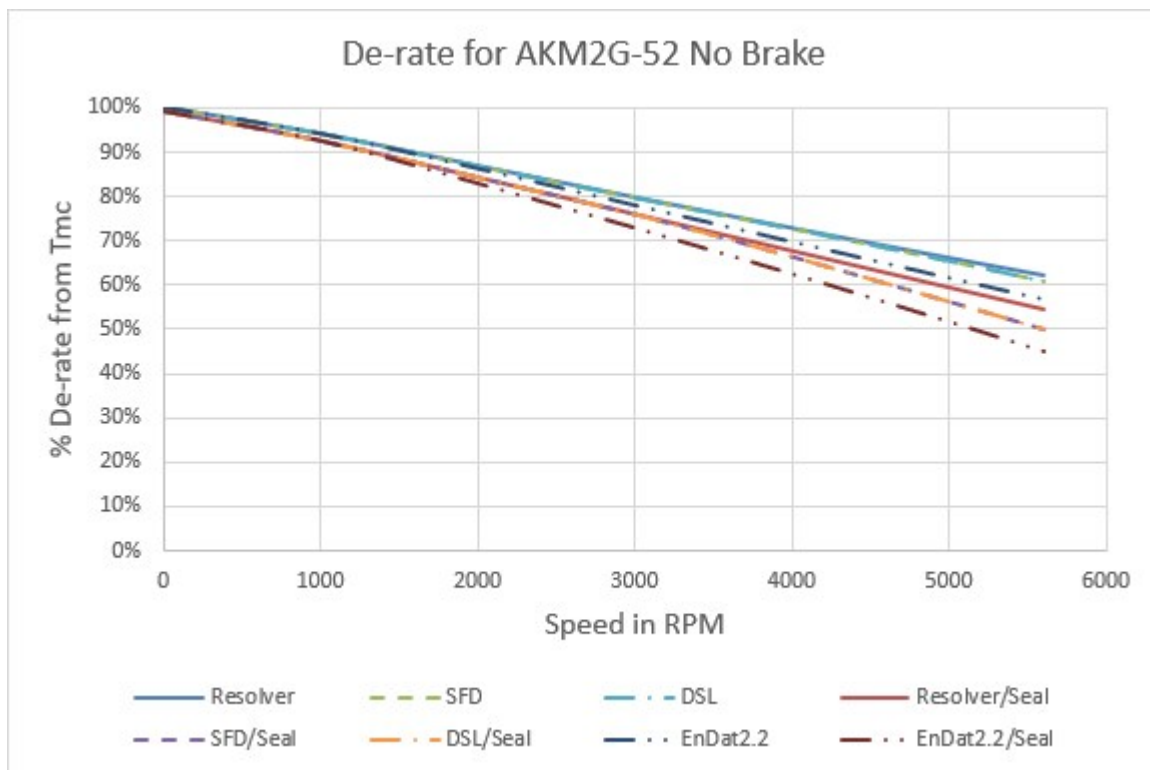

Note: For EnDat feedback motors acceleration of the motor is limited to $\leq 1 \cdot 10^5$ rad/s². The connected servo drive may further limit this value.

7.5.3 Technical Data AKM2G-53

UN	Parameter	Tolerance	Symbol	Units	AKM2G		
					53H	53L	53M
Electrical data							
	Max. Rated Equivalent Line Voltage	Max	V bus	V ac	480	480	400
	Max. Continuous Torque for ΔT winding = 100°C (1)(2)(4)	Nom	Tmc	Nm	16.2	16.0	16.1
				lb-in	144	142	142
	Max. Continuous Current for ΔT winding = 100°C (1)(2)(4)	Nom	Imc	Arms	5.69	12.5	14.2
	Max. Continuous Torque for ΔT winding = 60°C (2)(4)	Nom	Tmc	Nm	12.7	12.7	12.7
				lb-in	113	113	112
	Max. mechanical speed (5)	Nom	Nmax	rpm	6000	6000	6000
Peak Torque (1)(2)(4)	Nom	Tp	Nm	41.8	41.4	41.4	
			lb-in	370	366	367	
Peak Current	Nom	Ip	Arms	17.1	37.6	42.5	
120 V AC	Rated Torque (speed) (1)(2)(4)		Trtd	Nm		15.6	15.4
				lb-in		138	136
	Rated Speed		Nrtd	rpm		1100	1300
	Rated Power (speed) (1)(2)(4)		Prtd	kW		1.80	2.09
Hp					2.41	2.81	
240 V AC	Rated Torque (speed) (1)(2)(4)		Trtd	Nm	15.7	14.1	13.5
				lb-in	139	124	120
	Rated Speed		Nrtd	rpm	1000	2400	2800
	Rated Power (speed) (1)(2)(4)		Prtd	kW	1.65	3.53	3.97
Hp				2.21	4.74	5.33	
400 V AC	Rated Torque (speed) (1)(2)(4)		Trtd	Nm	14.9	10.9	9.74
				lb-in	132	96.1	86.2
	Rated Speed		Nrtd	rpm	1800	4200	4800
	Rated Power (speed) (1)(2)(4)		Prtd	kW	2.81	4.77	4.90
Hp				3.77	6.40	6.57	
480 V AC	Rated Torque (speed) (1)(2)(4)		Trtd	Nm	14.4	8.64	
				lb-in	128	76.5	
	Rated Speed		Nrtd	rpm	2200	5100	
	Rated Power (speed) (1)(2)(4)		Prtd	kW	3.32	4.61	
Hp				4.46	6.19		

UN	Parameter	Tolerance	Symbol	Units	AKM2G		
					53H	53L	53M
	Torque Constant (1)	+/- 10%	Kt	Nm/Arms	2.87	1.29	1.14
				lb-in/Arms	25.4	11.4	10.1
	Back EMF Constant (6)	+/- 10%	Ke	Vrms/krpm	194	87.1	77.1
	Motor Constant (1)	Nom	Km	Nm/ \sqrt{W}	1.32	1.32	1.32
				lb-in/ \sqrt{W}	11.7	11.7	11.6
	Resistance (line-line) (6)	+/- 10%	Rm	Ω	3.15	0.635	0.500
	Inductance Q-Axis (line-line)		Lqll	mH	35.5	7.15	5.60
	Inductance D-Axis (line-line)		Ldll	mH	TBD	TBD	TBD
	Inductance Saturation Current		Lisat	Arms	81.3	181	205
	Maximum Demagnetization Current		Midpeak	Arms	TBD	TBD	TBD

U N	Parameter	Tolerance	Symbol	Units	AKM2G		
					53H	53L	53M
Mechanical Data							
	Inertia (incl. Resolver feedback) (3)		Jm	kgcm ²	6.64		
				lb-in-s ²	5.88E-03		
	Optional Brake Inertia (additional)		Jm	kgcm ²	1.20		
				lb-in-s ²	1.06E-03		
	Weight (8)		W	kg	8.89		
				lb	19.6		
	Static Friction (1)		Tf	Nm	0.0830		
				lb-in	0.735		
	Viscous Damping (1)		Kdv	Nm/krpm	0.033		
				lb-in/krpm	0.292		
	Thermal Time Constant		TCT	mins.	38		
	Thermal Resistance		Rthw-a	°C/W	0.440		
	Pole Pairs		PP		5		
	Heatsink Size				12" x 12" x 1/2" Aluminum Plate		

1. Motor winding at temp. rise, $\delta T = 100^{\circ}\text{C}$, at 40°C ambient
2. All data referenced to sinusoidal commutation
3. Add parking brake if applicable for total inertia
4. Motor with resolver feedback and standard heat sink
5. May be limited at some values of V_{bus}
6. Measured at 25°C
7. See de-rate chart for the de-rate of different motor options.
8. Brake motor adds 2.6 kg [5.7 lbs]
9. Shaft seal increases Static Friction by 0.07 Nm [0.62 lb-in]

Brake options are listed in chapter "Technical Data Brakes" from [Technical Data Brakes](#).

7.5.3.1 AKM2G-53 Derates for Different Options

Note: Derate information is for general estimation only. For the most accurate information for your motor use the online Performance Curve Generator located at pcgh.kollmorgen.com, the AKM2G Performance Curves document available for download at www.kollmorgen.com/sites/default/files/public_downloads/AKM2G%20Performance%20Curves_0.pdf, or refer to Kollmorgen's Motioneering Software Tool at www.kollmorgen.com/en-us/service-and-support/technical/motioneering-online/.

De-rates are referenced to the Max Continuous Torque ΔT wdg. = 100°C

Options - No Brake	Speed: RPM						
	0	1000	2000	3000	4000	4800	5100
Resolver	100.0%	92.2%	82.5%	73.0%	63.7%	56.4%	53.8%
Resolver/Seal	99.4%	90.8%	80.1%	69.2%	58.3%	49.7%	46.5%
SFD	100.0%	92.2%	81.7%	70.6%	59.5%	50.7%	47.5%
SFD/Seal	99.4%	90.8%	78.7%	65.8%	52.4%	41.2%	37.0%
DSL	100.0%	92.2%	81.7%	70.6%	59.5%	50.7%	47.5%
DSL/Seal	99.4%	90.8%	78.7%	65.8%	52.4%	41.2%	37.0%
EnDat2.2	99.0%	90.0%	78.6%	67.0%	55.3%	45.9%	42.4%
EnDat2.2/Seal	98.3%	88.4%	75.5%	61.9%	47.5%	35.4%	

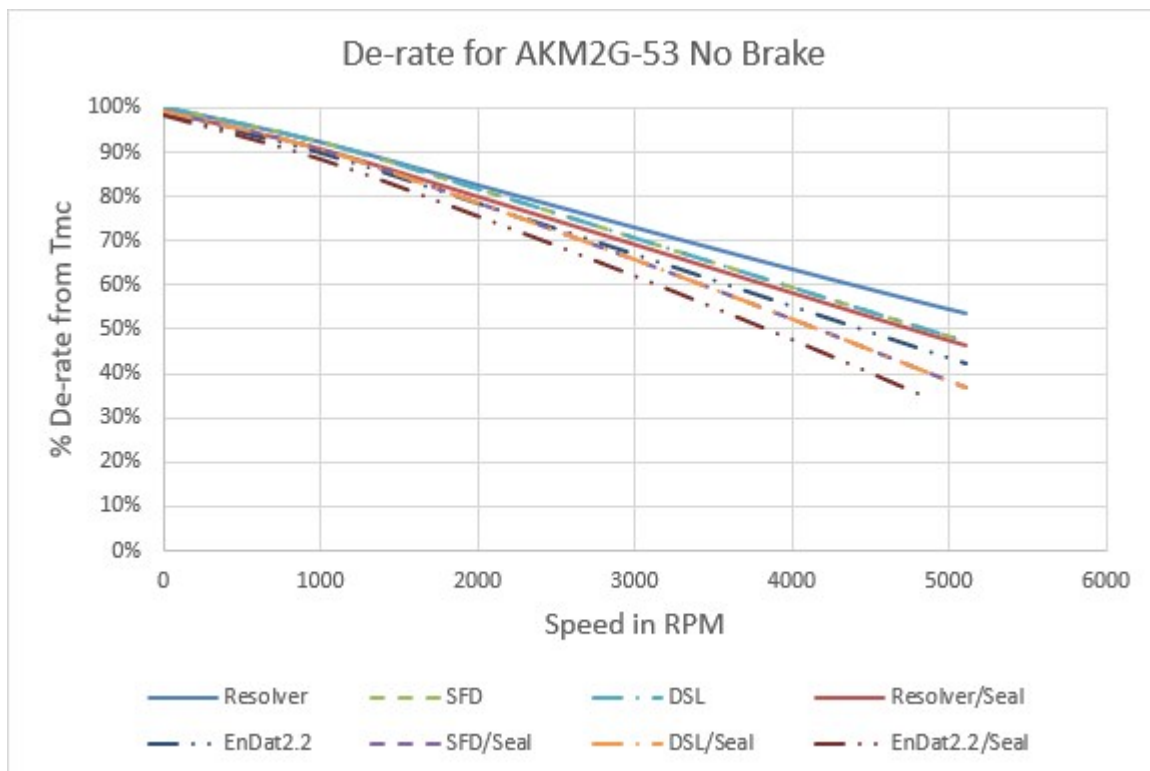

De-rates are referenced to the Max Continuous Torque ΔT wdg. = 100°C

Options - Brake	Speed: RPM						
	0	1000	2000	3000	4000	4800	5100
Resolver	99.7%	91.8%	82.2%	72.6%	63.2%	55.9%	53.2%
Resolver/Seal	99.1%	90.5%	79.7%	68.8%	57.8%	47.7%	43.9%
SFD	99.7%	91.8%	81.7%	70.6%	59.5%	50.7%	47.5%
SFD/Seal	99.1%	90.5%	78.7%	65.8%	52.4%	41.2%	37.0%
DSL	99.7%	91.8%	81.7%	70.6%	59.5%	50.7%	47.5%
DSL/Seal	99.1%	90.5%	78.7%	65.8%	52.4%	41.2%	37.0%
EnDat2.2	98.9%	89.9%	78.6%	67.0%	55.3%	45.9%	42.4%
EnDat2.2/Seal	98.2%	88.3%	75.4%	61.9%	47.5%	35.4%	

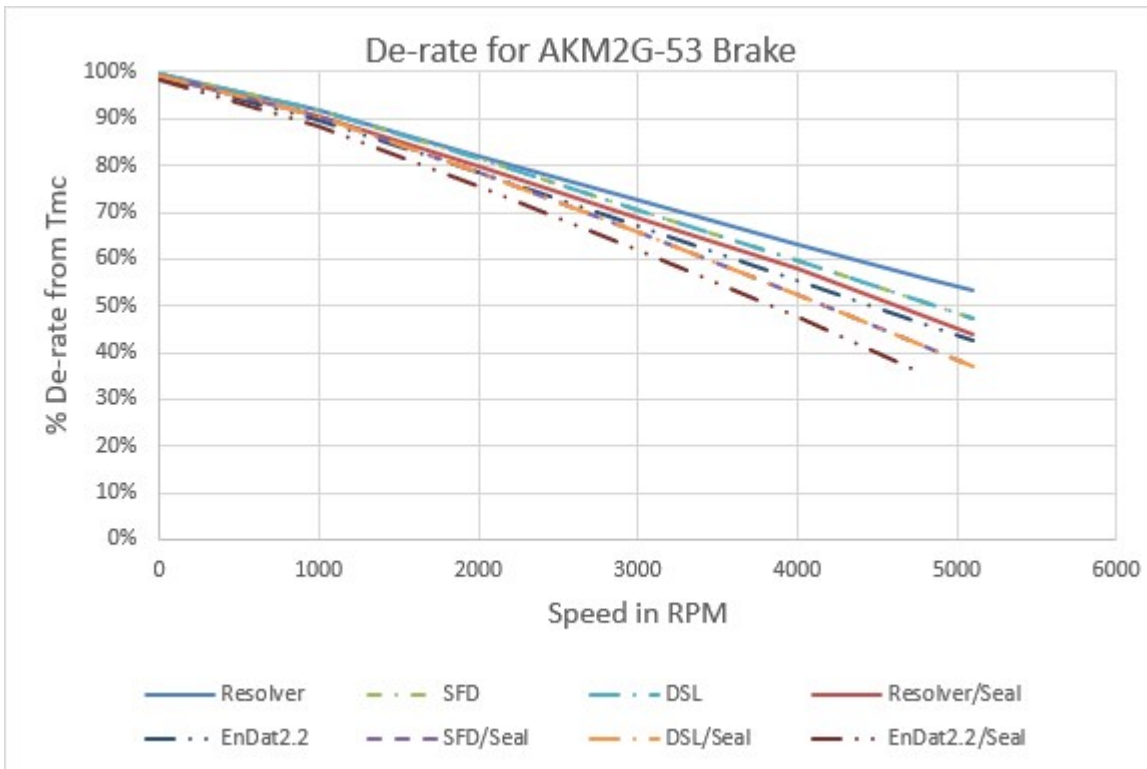

Note: For EnDat feedback motors acceleration of the motor is limited to $\leq 1 \cdot 10^5$ rad/s². The connected servo drive may further limit this value.

7.5.4 Technical Data AKM2G-54

UN	Parameter	Tolerance	Symbol	Units	AKM2G		
					54L	54M	54N
Electrical data							
	Max. Rated Equivalent Line Voltage	Max	V bus	V ac	480	480	400
	Max. Continuous Torque for ΔT winding = 100°C (1)(2)(4)	Nom	Tmc	Nm	20.1	20.0	20.0
				lb-in	178	177	177
	Max. Continuous Current for ΔT winding = 100°C (1)(2)(4)	Nom	Imc	Arms	10.6	14.6	16.3
	Max. Continuous Torque for ΔT winding = 60°C (2)(4)	Nom	Tmc	Nm	15.9	15.9	15.9
				lb-in	141	141	141
	Max. mechanical speed (5)	Nom	Nmax	rpm	6000	6000	6000
	Peak Torque (1)(2)(4)	Nom	Tp	Nm	54.8	54.7	54.7
lb-in				485	484	484	
Peak Current	Nom	Ip	Arms	31.7	43.9	48.8	
120 V AC	Rated Torque (speed) (1)(2)(4)		Trtd	Nm		19.3	19.1
				lb-in		171	169
	Rated Speed		Nrtd	rpm		1100	1200
	Rated Power (speed) (1)(2)(4)		Prtd	kW		2.22	2.40
Hp					2.98	3.22	
240 V AC	Rated Torque (speed) (1)(2)(4)		Trtd	Nm	18.4	17.2	16.5
				lb-in	163	152	146
	Rated Speed		Nrtd	rpm	1600	2300	2600
	Rated Power (speed) (1)(2)(4)		Prtd	kW	3.09	4.13	4.49
Hp				4.14	5.54	6.02	
400 V AC	Rated Torque (speed) (1)(2)(4)		Trtd	Nm	15.9	12.9	11.0
				lb-in	141	114	97.6
	Rated Speed		Nrtd	rpm	2800	3900	4500
	Rated Power (speed) (1)(2)(4)		Prtd	kW	4.66	5.28	5.20
Hp				6.25	7.08	6.97	
480 V AC	Rated Torque (speed) (1)(2)(4)		Trtd	Nm	14.3	9.80	
				lb-in	126	86.7	
	Rated Speed		Nrtd	rpm	3400	4800	
	Rated Power (speed) (1)(2)(4)		Prtd	kW	5.08	4.92	
Hp				6.81	6.60		

UN	Parameter	Tolerance	Symbol	Units	AKM2G		
					54L	54M	54N
	Torque Constant (1)	+/- 10%	Kt	Nm/Arms	1.91	1.38	1.24
				lb-in/Arms	16.9	12.2	11.0
	Back EMF Constant (6)	+/- 10%	Ke	Vrms/krpm	130	93.3	83.8
	Motor Constant (1)	Nom	Km	Nm/ \sqrt{W}	1.57	1.57	1.57
				lb-in/ \sqrt{W}	13.9	13.9	13.9
	Resistance (line-line) (6)	+/- 10%	Rm	Ω	0.991	0.514	0.416
	Inductance Q-Axis (line-line)		Lqll	mH	11.6	6.0	4.9
	Inductance D-Axis (line-line)		Ldll	mH	TBD	TBD	TBD
	Inductance Saturation Current		Lisat	Arms	163	226	251
Maximum Demagnetization Current		Midpeak	Arms	TBD	TBD	TBD	

U N	Parameter	Tolerance	Symbol	Units	AKM2G		
					54L	54M	54N
Mechanical Data							
	Inertia (incl. Resolver feedback) (3)		Jm	kgcm ²	8.70		
				lb-in-s ²	7.70E-03		
	Optional Brake Inertia (additional)		Jm	kgcm ²	1.20		
				lb-in-s ²	1.06E-03		
	Weight (8)		W	kg	10.8		
				lb	23.8		
	Static Friction (1)		Tf	Nm	0.110		
				lb-in	0.974		
	Viscous Damping (1)		Kdv	Nm/krpm	0.0427		
				lb-in/krpm	0.378		
	Thermal Time Constant		TCT	mins.	43		
	Thermal Resistance		Rthw-a	°C/W	0.399		
	Pole Pairs		PP		5		
	Heatsink Size				12" x 12" x 1/2" Aluminum Plate		

1. Motor winding at temp. rise, $\delta T = 100^{\circ}\text{C}$, at 40°C ambient
2. All data referenced to sinusoidal commutation
3. Add parking brake if applicable for total inertia
4. Motor with resolver feedback and standard heat sink
5. May be limited at some values of V_{bus}
6. Measured at 25°C
7. See de-rate chart for the de-rate of different motor options.
8. Brake motor adds 2.6 kg [5.7 lbs]
9. Shaft seal increases Static Friction by 0.07 Nm [0.62 lb-in]

Brake options are listed in chapter "Technical Data Brakes" from [Technical Data Brakes](#).

7.5.4.1 AKM2G-54 Derates for Different Options

Note: Derate information is for general estimation only. For the most accurate information for your motor use the online Performance Curve Generator located at pcgh.kollmorgen.com, the AKM2G Performance Curves document available for download at www.kollmorgen.com/sites/default/files/public_downloads/AKM2G%20Performance%20Curves_0.pdf, or refer to Kollmorgen's Motioneering Software Tool at www.kollmorgen.com/en-us/service-and-support/technical/motioneering-online/.

De-rates are referenced to the Max Continuous Torque ΔT wdg. = 100°C

Options - No Brake	Speed: RPM						
	0	1000	2000	3000	4000	4500	4800
Resolver	100.0%	91.4%	80.4%	69.2%	57.8%	52.2%	48.9%
Resolver/Seal	99.5%	90.1%	78.1%	65.5%	52.5%	45.9%	42.4%
SFD	99.2%	89.5%	76.8%	63.5%	49.4%	42.2%	37.9%
SFD/Seal	98.6%	88.1%	74.1%	59.0%	42.4%	33.6%	
DSL	99.2%	89.5%	76.8%	63.5%	49.4%	42.2%	37.9%
DSL/Seal	98.6%	88.1%	74.1%	59.0%	42.4%	33.6%	
EnDat2.2	96.9%	86.8%	73.6%	59.6%	44.6%	36.8%	32.2%
EnDat2.2/Seal	96.3%	85.4%	70.8%	54.8%	36.9%		

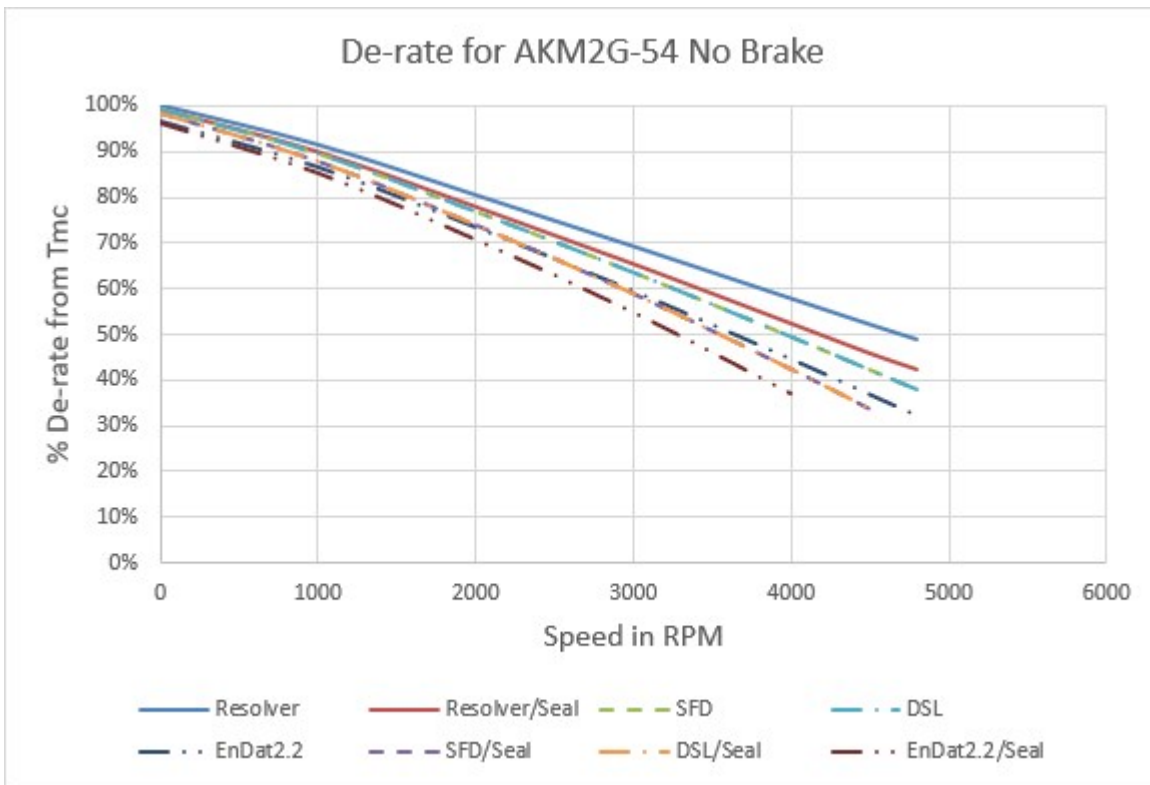

De-rates are referenced to the Max Continuous Torque ΔT wdg. = 100°C

Options - Brake	Speed: RPM						
	0	1000	2000	3000	4000	4500	4800
Resolver	99.8%	91.2%	80.2%	68.1%	55.0%	48.4%	44.4%
Resolver/Seal	99.3%	89.9%	77.8%	63.9%	48.7%	40.8%	36.3%
SFD	99.2%	89.5%	76.8%	63.5%	49.4%	42.2%	37.9%
SFD/Seal	98.6%	88.1%	74.1%	59.0%	42.4%	33.6%	
DSL	99.2%	89.5%	76.8%	63.5%	49.4%	42.2%	37.9%
DSL/Seal	98.6%	88.1%	74.1%	59.0%	42.4%	33.6%	
EnDat2.2	96.9%	86.8%	73.6%	59.6%	44.6%	36.8%	32.2%
EnDat2.2/Seal	96.3%	85.4%	70.8%	54.8%	36.9%		

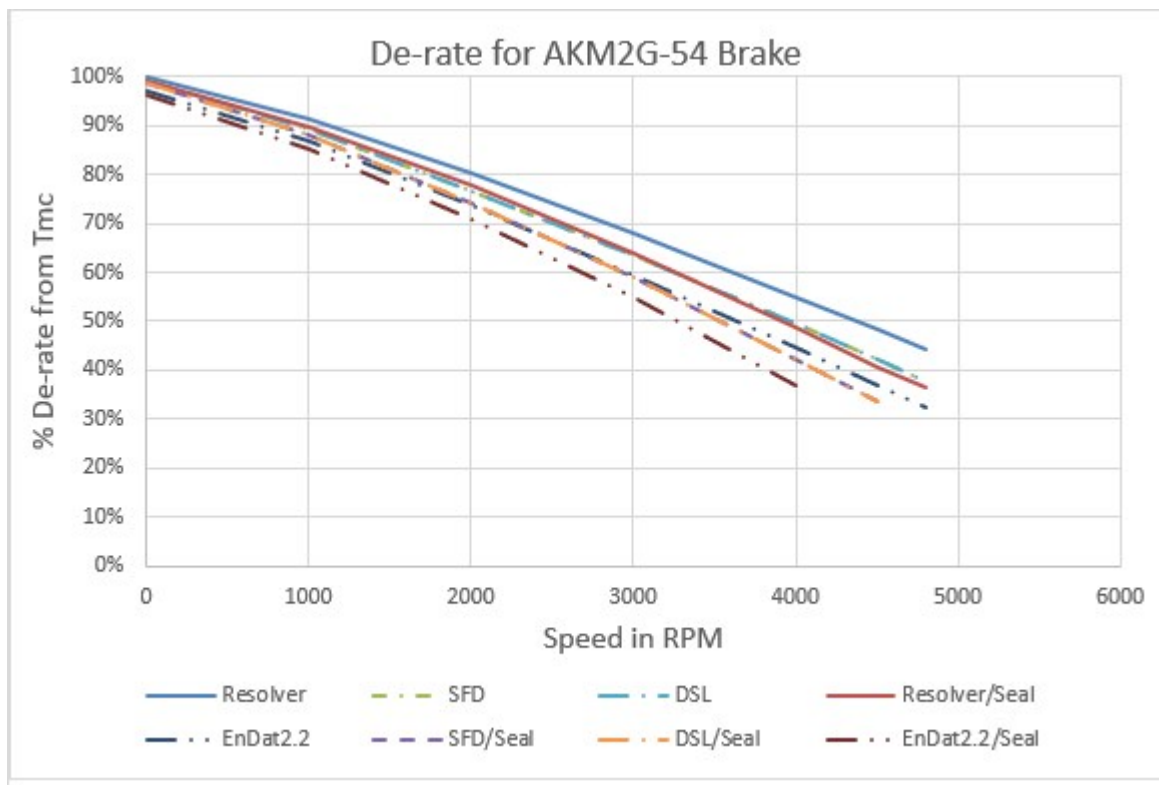

Note: For EnDat feedback motors acceleration of the motor is limited to $\leq 1 \cdot 10^5$ rad/s². The connected servo drive may further limit this value.

7.6 Technical Data AKM2G-6x Series

7.6.1 Technical Data AKM2G-62

UN	Parameter	Tolerance	Symbol	Units	AKM2G		
					62K	62L	62M
Electrical data							
	Max. Rated Equivalent Line Voltage	Max	V bus	V ac	480	480	400
	Max. Continuous Torque for ΔT winding = 100°C (1)(2)(4)	Nom	Tmc	Nm	15.3	15.2	15.1
				lb-in	135	134	134
	Max. Continuous Current for ΔT winding = 100°C (1)(2)(4)	Nom	Imc	Arms	9.32	11.6	14.6
	Max. Continuous Torque for ΔT winding = 60°C (2)(4)	Nom	Tmc	Nm	12.0	12.0	11.9
				lb-in	106	106	106
	Max. mechanical speed (5)	Nom	Nmax	rpm	6000	6000	6000
	Peak Torque (1)(2)(4)	Nom	Tp	Nm	37.6	37.4	37.4
				lb-in	332	331	331
	Peak Current	Nom	Ip	Arms	28.0	34.9	43.7
120 V AC	Rated Torque (speed) (1)(2)(4)		Trtd	Nm		14.9	14.6
				lb-in		132	130
	Rated Speed		Nrtd	rpm		1000	1300
	Rated Power (speed) (1)(2)(4)		Prtd	kW		1.56	1.99
Hp					2.09	2.67	
240 V AC	Rated Torque (speed) (1)(2)(4)		Trtd	Nm	14.4	13.8	13.1
				lb-in	127	122	116
	Rated Speed		Nrtd	rpm	1700	2200	2800
	Rated Power (speed) (1)(2)(4)		Prtd	kW	2.56	3.19	3.85
Hp				3.43	4.27	5.16	
400 V AC	Rated Torque (speed) (1)(2)(4)		Trtd	Nm	12.9	11.5	9.6
				lb-in	114	102	85
	Rated Speed		Nrtd	rpm	3000	3900	5000
	Rated Power (speed) (1)(2)(4)		Prtd	kW	4.05	4.70	5.03
Hp				5.42	6.31	6.74	
480 V AC	Rated Torque (speed) (1)(2)(4)		Trtd	Nm	11.9	9.84	
				lb-in	105	87.1	
	Rated Speed		Nrtd	rpm	3700	4800	
	Rated Power (speed) (1)(2)(4)		Prtd	kW	4.59	4.95	
Hp				6.16	6.63		

UN	Parameter	Tolerance	Symbol	Units	AKM2G		
					62K	62L	62M
	Torque Constant (1)	+/- 10%	Kt	Nm/Arms	1.64	1.31	1.04
				lb-in/Arms	14.5	11.6	9.2
	Back EMF Constant (6)	+/- 10%	Ke	Vrms/krpm	111	88.3	70.3
	Motor Constant (1)	Nom	Km	Nm/√W	1.25	1.25	1.24
				lb-in/√W	11.1	11.0	11.0
	Resistance (line-line) (6)	+/- 10%	Rm	Ω	1.15	0.732	0.468
	Inductance Q-Axis (line-line)		Lqll	mH	17.4	11.0	7.0
	Inductance D-Axis (line-line)		Ldll	mH	TBD	TBD	TBD
	Inductance Saturation Current		Lisat	Arms	250	314	394
Maximum Demagnetization Current		Midpeak	Arms	TBD	TBD	TBD	
UN	Parameter	Tolerance	Symbol	Units	AKM2G		
					62K	62L	62M
Mechanical Data							
	Inertia (incl. Resolver feedback) (3)		Jm	kgcm ²	9.10		
				lb-in-s ²	8.05E-03		
	Optional Brake Inertia (additional)		Jm	kgcm ²	3.60		
				lb-in-s ²	3.19E-03		
	Weight (8)		W	kg	10.0		
				lb	22.0		
	Static Friction (1)		Tf	Nm	0.0400		
				lb-in	0.354		
	Viscous Damping (1)		Kdv	Nm/krpm	0.0370		
				lb-in/krpm	0.327		
	Thermal Time Constant		TCT	mins.	40		
	Thermal Resistance		Rthw-a	°C/W	0.448		
	Pole Pairs		PP		5		
	Heatsink Size				18" x 18" x 1/2" Aluminum Plate		

1. Motor winding at temp. rise, $\delta T = 100^{\circ}\text{C}$, at 40°C ambient
2. All data referenced to sinusoidal commutation
3. Add parking brake if applicable for total inertia
4. Motor with resolver feedback and standard heat sink
5. May be limited at some values of V_{bus}
6. Measured at 25°C
7. See de-rate chart for the de-rate of different motor options.
8. Brake motor adds 4.5 kg [10lbs]
9. Shaft seal increases Static Friction by 0.12 Nm [1.06 lb-in]

Brake options are listed in chapter "Technical Data Brakes" from [Technical Data Brakes](#).

7.6.1.1 AKM2G-62 Derates for Different Options

Note: Derate information is for general estimation only. For the most accurate information for your motor use the online Performance Curve Generator located at pcgh.kollmorgen.com, the AKM2G Performance Curves document available for download at www.kollmorgen.com/sites/default/files/public_downloads/AKM2G%20Performance%20Curves_0.pdf, or refer to Kollmorgen's Motioneering Software Tool at www.kollmorgen.com/en-us/service-and-support/technical/motioneering-online/.

De-rates are referenced to the Max Continuous Torque ΔT wdg. = 100°C

Options - No Brake	Speed: RPM						
	0	1000	2000	3000	4000	4500	5000
Resolver	100.0%	93.9%	86.3%	78.7%	71.1%	67.2%	63.4%
Resolver/Seal	99.0%	92.0%	83.1%	74.2%	64.8%	60.0%	55.1%
SFD	100.0%	93.9%	86.3%	78.7%	71.1%	67.2%	63.4%
SFD/Seal	99.0%	92.0%	83.1%	74.2%	64.6%	57.8%	50.7%
DSL	100.0%	93.9%	86.3%	78.6%	68.9%	63.7%	58.3%
DSL/Seal	99.0%	92.0%	82.8%	70.7%	56.9%	49.3%	
EnDat2.2	100.0%	93.9%	85.0%	75.5%	65.1%	59.6%	53.9%
EnDat2.2/Seal	99.0%	91.3%	79.8%	67.0%	52.3%	44.0%	

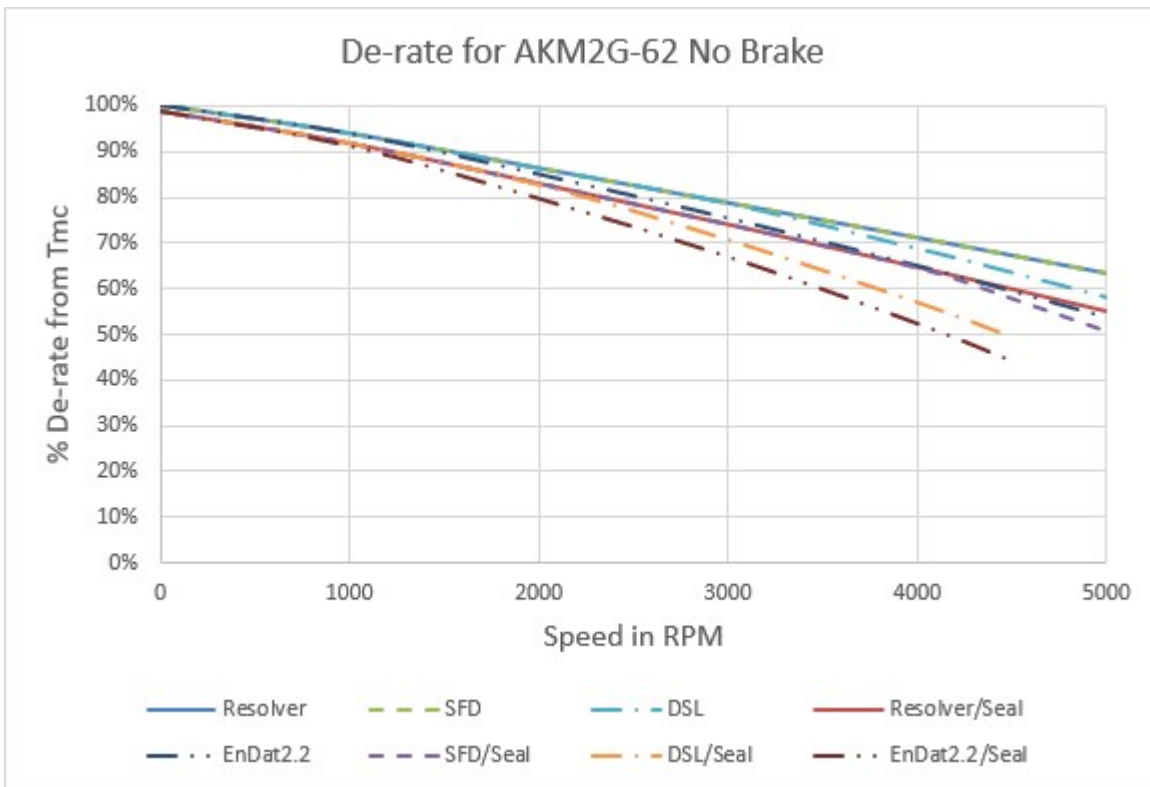

De-rates are referenced to the Max Continuous Torque ΔT wdg. = 100°C

Options - Brake	Speed: RPM						
	0	1000	2000	3000	4000	4500	5000
Resolver	99.8%	93.7%	86.0%	78.5%	70.9%	67.0%	63.0%
Resolver/Seal	98.8%	91.7%	82.9%	73.9%	62.4%	55.5%	48.0%
SFD	99.8%	93.7%	86.0%	78.5%	70.8%	66.2%	61.0%
SFD/Seal	98.8%	91.7%	82.9%	73.0%	59.8%	52.5%	44.7%
DSL	99.8%	93.3%	84.1%	74.4%	63.9%		
DSL/Seal	98.8%	90.5%	78.8%	65.8%	50.8%		
EnDat2.2	96.6%	89.0%	79.2%	68.7%	57.2%		
EnDat2.2/Seal	95.4%	86.1%	73.5%	59.1%	42.1%		

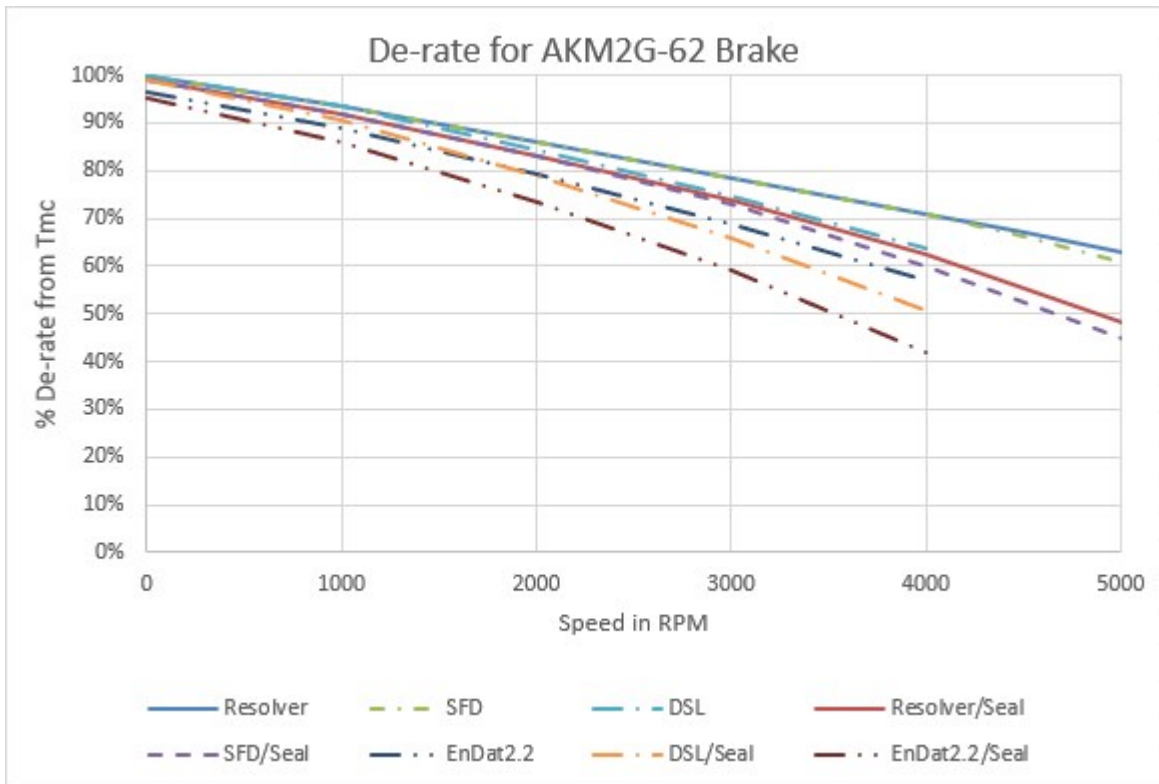

Note: For EnDat feedback motors acceleration of the motor is limited to $\leq 1 \cdot 10^5$ rad/s². The connected servo drive may further limit this value.

7.6.2 Technical Data AKM2G-63

UN	Parameter	Tolerance	Symbol	Units	AKM2G			
					63H	63K	63M	63N
Electrical data								
	Max. Rated Equivalent Line Voltage	Max	V bus	V ac	480	480	480	400
	Max. Continuous Torque for ΔT winding = 100°C (1)(2)(4)	Nom	Tmc	Nm	21.7	21.5	21.4	21.4
				ib-in	192	190	189	189
	Max. Continuous Current for ΔT winding = 100°C (1)(2)(4)	Nom	Imc	Arms	6.11	9.79	15.2	16.8
	Max. Continuous Torque for ΔT winding = 60°C (2)(4)	Nom	Tmc	Nm	17.0	16.9	16.9	16.9
				lb-in	150	150	149	149
	Max. mechanical speed (5)	Nom	Nmax	rpm	6000	6000	6000	6000
	Peak Torque (1)(2)(4)	Nom	Tp	Nm	55.1	54.7	54.5	54.5
				lb-in	487	484	482	482
	Peak Current	Nom	Ip	Arms	18.3	29.4	45.5	50.5
120 V AC	Rated Torque (speed) (1)(2)(4)		Trtd	Nm			20.9	20.7
				lb-in			185	183
	Rated Speed		Nrtd	rpm			1000	1100
	Rated Power (speed) (1)(2)(4)		Prtd	kW			2.19	2.39
				Hp			2.93	3.20
240 V AC	Rated Torque (speed) (1)(2)(4)		Trtd	Nm	21.5	20.5	19.2	18.7
				lb-in	191	181	170	166
	Rated Speed		Nrtd	rpm	750	1300	2100	2300
	Rated Power (speed) (1)(2)(4)		Prtd	kW	1.69	2.79	4.21	4.51
				Hp	2.27	3.74	5.65	6.05
400 V AC	Rated Torque (speed) (1)(2)(4)		Trtd	Nm	20.6	18.9	15.6	14.1
				lb-in	182	167	138	125
	Rated Speed		Nrtd	rpm	1300	2200	3600	4100
	Rated Power (speed) (1)(2)(4)		Prtd	kW	2.80	4.35	5.88	6.07
				Hp	3.75	5.84	7.89	8.14
480 V AC	Rated Torque (speed) (1)(2)(4)		Trtd	Nm	20.1	17.8	12.8	
				lb-in	178	158	114	
	Rated Speed		Nrtd	rpm	1600	2700	4500	
	Rated Power (speed) (1)(2)(4)		Prtd	kW	3.37	5.03	6.05	
				Hp	4.52	6.75	8.12	

UN	Parameter	Tolerance	Symbol	Units	AKM2G			
					63H	63K	63M	63N
	Torque Constant (1)	+/- 10%	Kt	Nm/Arms	3.56	2.20	1.41	1.27
				lb-in/Arms	31.5	19.5	12.5	11.3
	Back EMF Constant (6)	+/- 10%	Ke	Vrms/krpm	240	148.8	95.5	86.0
	Motor Constant (1)	Nom	Km	Nm/ \sqrt{W}	1.66	1.65	1.65	1.65
				lb-in/ \sqrt{W}	14.7	14.6	14.6	14.6
	Resistance (line-line) (6)	+/- 10%	Rm	Ω	3.07	1.184	0.491	0.398
	Inductance Q-Axis (line-line)		Lqll	mH	51.6	19.8	8.2	6.6
	Inductance D-Axis (line-line)		Ldll	mH	TBD	TBD	TBD	TBD
	Inductance Saturation Current		Lisat	Arms	175	282	439	488
	Maximum Demagnetization Current		Midpeak	Arms	TBD	TBD	TBD	TBD

U N	Parameter	Tolerance	Symbol	Units	AKM2G			
					63H	63K	63M	63N
Mechanical Data								
	Inertia (incl. Resolver feedback) (3)		Jm	kgcm ²	13.0			
				lb-in-s ²	1.15E-02			
	Optional Brake Inertia (additional)		Jm	kgcm ²	3.60			
				lb-in-s ²	3.19E-03			
	Weight (8)		W	kg	12.3			
				lb	27.0			
	Static Friction (1)		Tf	Nm	0.060			
				lb-in	0.531			
	Viscous Damping (1)		Kdv	Nm/krpm	0.053			
				lb-in/krpm	0.469			
	Thermal Time Constant		TCT	mins.	50			
	Thermal Resistance		Rthw-a	°C/W	0.393			
	Pole Pairs		PP		5			
	Heatsink Size				18" x 18" x 1/2" Aluminum Plate			

1. Motor winding at temp. rise, $\delta T = 100^{\circ}\text{C}$, at 40°C ambient
2. All data referenced to sinusoidal commutation
3. Add parking brake if applicable for total inertia
4. Motor with resolver feedback and standard heat sink
5. May be limited at some values of V_{bus}
6. Measured at 25°C
7. See de-rate chart for the de-rate of different motor options.
8. Brake motor adds 4.5 kg [10lbs]
9. Shaft seal increases Static Friction by 0.12 Nm [1.06 lb-in]

Brake options are listed in chapter "Technical Data Brakes" from [Technical Data Brakes](#).

7.6.2.1 AKM2G-63 Derates for Different Options

Note: Derate information is for general estimation only. For the most accurate information for your motor use the online Performance Curve Generator located at pcgh.kollmorgen.com, the AKM2G Performance Curves document available for download at www.kollmorgen.com/sites/default/files/public_downloads/AKM2G%20Performance%20Curves_0.pdf, or refer to Kollmorgen's Motioneering Software Tool at www.kollmorgen.com/en-us/service-and-support/technical/motioneering-online/.

De-rates are referenced to the Max Continuous Torque ΔT wdg. = 100°C

Options - No Brake	Speed: RPM						
	0	1000	2000	3000	3500	4000	4500
Resolver	100.0%	93.0%	84.1%	74.8%	70.0%	65.1%	60.1%
Resolver/Seal	99.3%	91.5%	81.4%	70.8%	65.2%	59.4%	53.6%
SFD	100.0%	93.0%	84.1%	74.8%	70.0%	65.1%	58.8%
SFD/Seal	99.3%	91.5%	81.4%	70.3%	63.0%	55.2%	46.8%
DSL	100.0%	93.0%	82.5%	70.9%	64.6%	58.0%	51.0%
DSL/Seal	99.3%	90.9%	78.2%	63.6%	55.4%	46.6%	
EnDat2.2	98.9%	90.6%	79.6%	67.3%	60.7%	53.7%	46.3%
EnDat2.2/Seal	98.0%	88.3%	74.9%	59.5%	50.8%	41.3%	

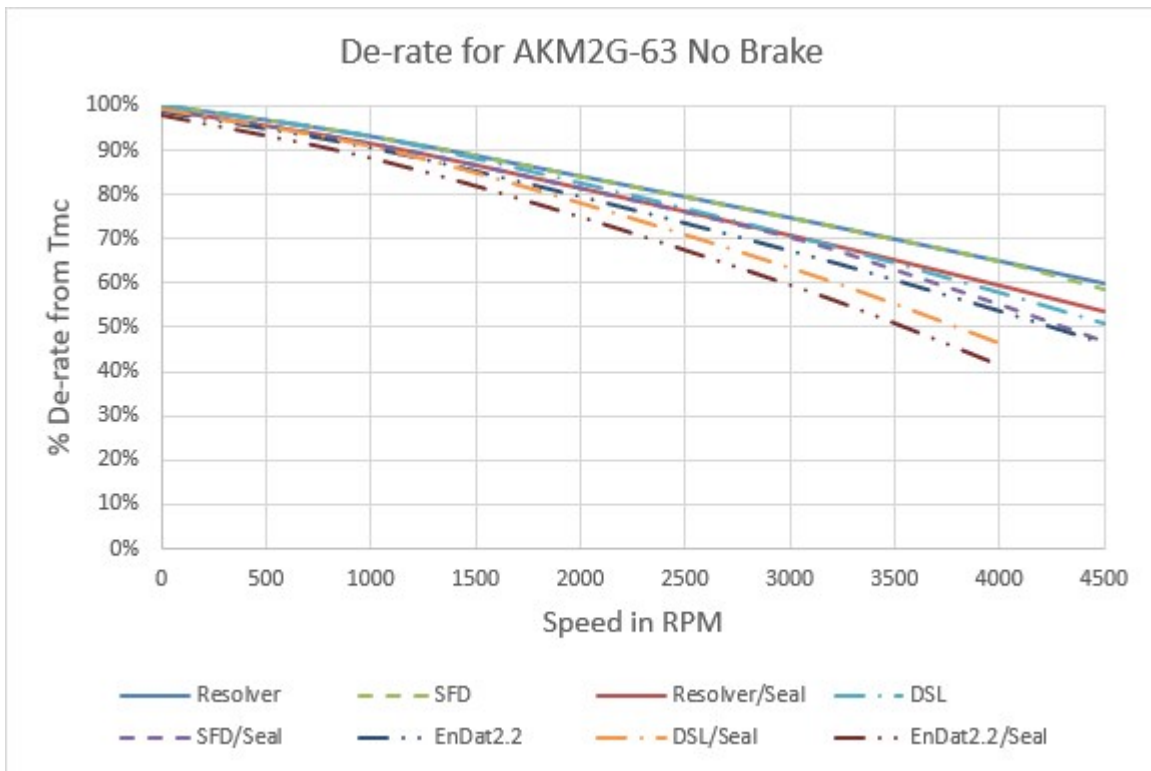

De-rates are referenced to the Max Continuous Torque ΔT wdg. = 100°C

Options - Brake	Speed: RPM						
	0	1000	2000	3000	3500	4000	4500
Resolver	99.2%	92.2%	83.2%	73.8%	69.0%	64.0%	58.5%
Resolver/Seal	98.4%	90.6%	80.5%	69.7%	62.7%	54.9%	46.5%
SFD	99.2%	92.2%	83.2%	73.8%	68.6%	62.4%	55.9%
SFD/Seal	98.4%	90.6%	80.5%	67.8%	60.2%	52.0%	43.3%
DSL	99.2%	91.0%	80.1%	68.0%	61.5%	54.6%	
DSL/Seal	98.3%	88.7%	75.5%	60.3%	51.8%	42.5%	
EnDat2.2	95.5%	86.8%	75.1%	62.0%	54.9%	47.3%	
EnDat2.2/Seal	94.6%	84.3%	70.1%	53.4%	43.8%		

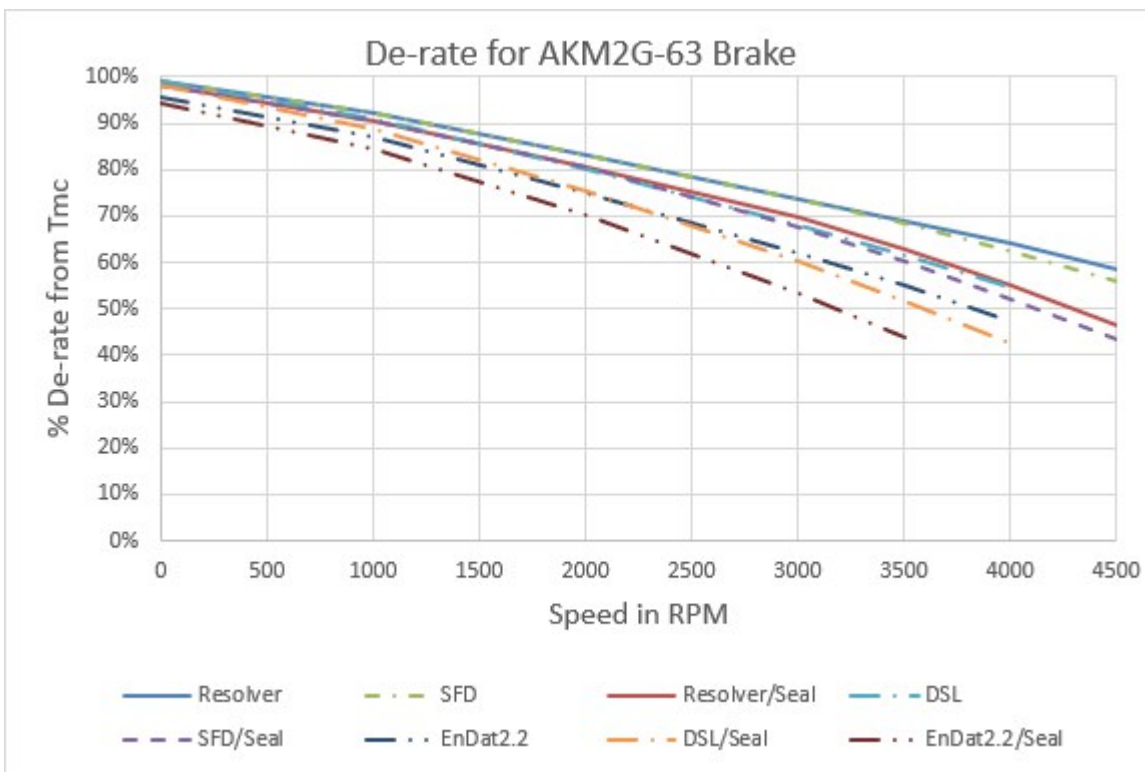

Note: For EnDat feedback motors acceleration of the motor is limited to $\leq 1 \cdot 10^5$ rad/s². The connected servo drive may further limit this value.

7.6.3 Technical Data AKM2G-64

UN	Parameter	Tolerance	Symbol	Units	AKM2G		
					64L	64M	64N
Electrical data							
	Max. Rated Equivalent Line Voltage	Max	V bus	V ac	480	480	480
	Max. Continuous Torque for ΔT winding = 100°C (1)(2)(4)	Nom	Tmc	Nm	27.0	26.9	26.8
				ib-in	239	238	237
	Max. Continuous Current for ΔT winding = 100°C (1)(2)(4)	Nom	Imc	Arms	11.4	15.8	17.8
	Max. Continuous Torque for ΔT winding = 60°C (2)(4)	Nom	Tmc	Nm	21.3	21.3	21.2
				lb-in	188	188	188
	Max. mechanical speed (5)	Nom	Nmax	rpm	6000	6000	6000
	Peak Torque (1)(2)(4)	Nom	Tp	Nm	70.7	70.5	70.3
				lb-in	626	624	622
	Peak Current	Nom	Ip	Arms	34.1	47.5	53.3
120 V AC	Rated Torque (speed) (1)(2)(4)		Trtd	Nm			26.2
				lb-in			232
	Rated Speed		Nrtd	rpm			900
	Rated Power (speed) (1)(2)(4)		Prtd	kW			2.47
Hp						3.32	
240 V AC	Rated Torque (speed) (1)(2)(4)		Trtd	Nm	25.7	24.6	23.8
				lb-in	227	217	211
	Rated Speed		Nrtd	rpm	1200	1700	2000
	Rated Power (speed) (1)(2)(4)		Prtd	kW	3.23	4.37	4.98
Hp				4.33	5.86	6.68	
400 V AC	Rated Torque (speed) (1)(2)(4)		Trtd	Nm	23.4	20.5	18.9
				lb-in	207	182	167
	Rated Speed		Nrtd	rpm	2100	3000	3400
	Rated Power (speed) (1)(2)(4)		Prtd	kW	5.15	6.45	6.72
Hp				6.91	8.65	9.01	
480 V AC	Rated Torque (speed) (1)(2)(4)		Trtd	Nm	21.9	17.7	15.2
				lb-in	194	156.3	134
	Rated Speed		Nrtd	rpm	2600	3700	4200
	Rated Power (speed) (1)(2)(4)		Prtd	kW	5.95	6.84	6.67
Hp				7.98	9.18	8.95	

UN	Parameter	Tolerance	Symbol	Units	AKM2G		
					64L	64M	64N
	Torque Constant (1)	+/- 10%	Kt	Nm/Arms	2.38	1.70	1.51
				lb-in/Arms	21.1	15.1	13.4
	Back EMF Constant (6)	+/- 10%	Ke	Vrms/krpm	161	115.2	102.4
	Motor Constant (1)	Nom	Km	Nm/ \sqrt{W}	1.99	1.98	1.98
				lb-in/ \sqrt{W}	17.6	17.6	17.5
	Resistance (line-line) (6)	+/- 10%	Rm	Ω	0.955	0.491	0.389
	Inductance Q-Axis (line-line)		Lqll	mH	16.9	8.7	6.8
	Inductance D-Axis (line-line)		Ldll	mH	TBD	TBD	TBD
	Inductance Saturation Current		Lisat	Arms	349	488	549
Maximum Demagnetization Current		Midpeak	Arms	TBD	TBD	TBD	

U N	Parameter	Tolerance	Symbol	Units	AKM2G		
					64L	64M	64N
Mechanical Data							
	Inertia (incl. Resolver feedback) (3)		Jm	kgcm ²	16.9		
				lb-in-s ²	1.49E-02		
	Optional Brake Inertia (additional)		Jm	kgcm ²	3.60		
				lb-in-s ²	3.19E-03		
	Weight (8)		W	kg	14.5		
				lb	32.0		
	Static Friction (1)		Tf	Nm	0.0800		
				lb-in	0.708		
	Viscous Damping (1)		Kdv	Nm/krpm	0.0680		
				lb-in/krpm	0.602		
	Thermal Time Constant		TCT	mins.	60		
	Thermal Resistance		Rthw-a	°C/W	0.359		
	Pole Pairs		PP		5		
	Heatsink Size				18" x 18" x 1/2" Aluminum Plate		

1. Motor winding at temp. rise, $\delta T = 100^{\circ}\text{C}$, at 40°C ambient
2. All data referenced to sinusoidal commutation
3. Add parking brake if applicable for total inertia
4. Motor with resolver feedback and standard heat sink
5. May be limited at some values of V_{bus}
6. Measured at 25°C
7. See de-rate chart for the de-rate of different motor options.
8. Brake motor adds 4.5 kg [10lbs]
9. Shaft seal increases Static Friction by 0.12 Nm [1.06 lb-in]

Brake options are listed in chapter "Technical Data Brakes" from [Technical Data Brakes](#).

7.6.3.1 AKM2G-64 Derates for Different Options

Note: Derate information is for general estimation only. For the most accurate information for your motor use the online Performance Curve Generator located at pcgh.kollmorgen.com, the AKM2G Performance Curves document available for download at www.kollmorgen.com/sites/default/files/public_downloads/AKM2G%20Performance%20Curves_0.pdf, or refer to Kollmorgen's Motioneering Software Tool at www.kollmorgen.com/en-us/service-and-support/technical/motioneering-online/.

De-rates are referenced to the Max Continuous Torque ΔT wdg. = 100°C

Options - No Brake	Speed: RPM						
	0	1000	2000	3000	3500	4000	4200
Resolver	100.0%	91.8%	81.3%	70.3%	64.6%	58.9%	56.5%
Resolver/Seal	99.4%	90.5%	78.9%	66.5%	60.1%	53.5%	50.8%
SFD	100.0%	91.8%	81.3%	69.0%	62.0%	54.6%	51.6%
SFD/Seal	99.4%	90.5%	78.3%	62.6%	54.0%	44.7%	40.9%
DSL	99.0%	89.5%	76.6%	62.3%	54.6%	46.4%	43.1%
DSL/Seal	98.3%	87.4%	72.4%	55.2%	45.4%		
EnDat2.2	96.7%	86.8%	73.4%	58.4%	50.1%	41.4%	37.9%
EnDat2.2/Seal	96.0%	84.7%	69.0%	50.6%	40.0%		

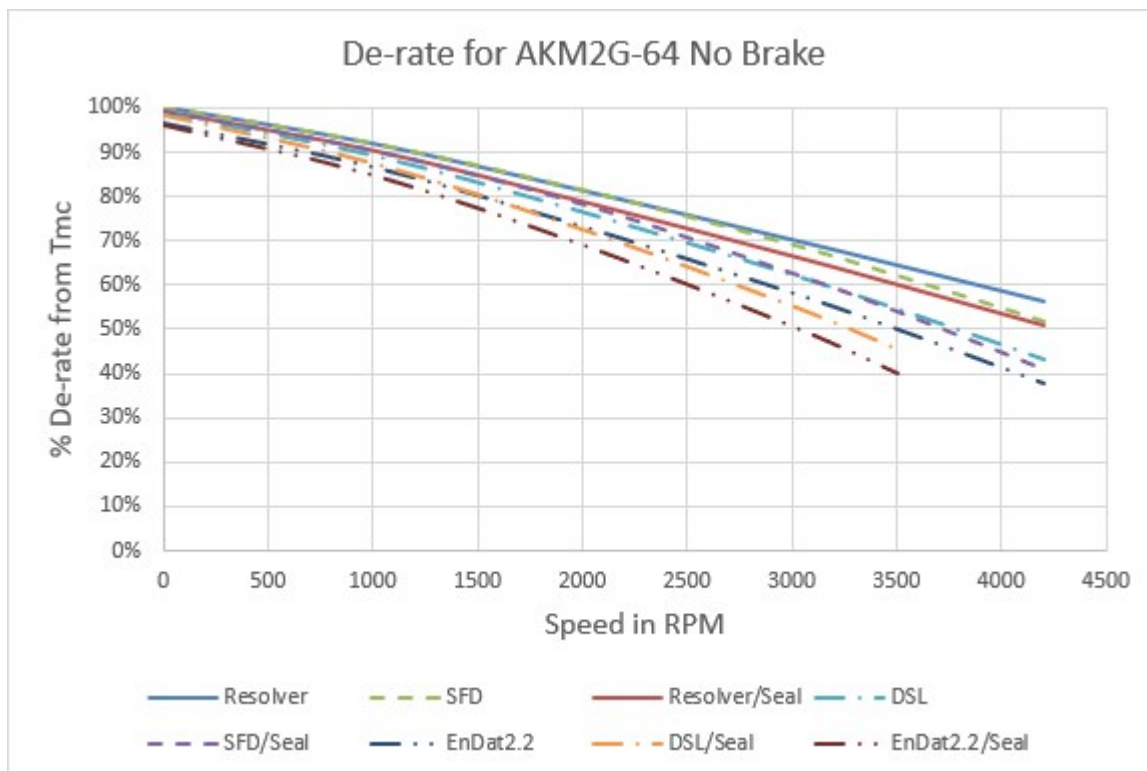

De-rates are referenced to the Max Continuous Torque ΔT wdg. = 100°C

Options - Brake	Speed: RPM						
	0	1000	2000	3000	3500	4000	4200
Resolver	98.5%	90.3%	79.6%	68.3%	61.3%	54.0%	51.0%
Resolver/Seal	97.9%	88.9%	77.1%	62.0%	53.3%	44.0%	40.2%
SFD	98.5%	90.3%	79.6%	66.1%	58.9%	51.3%	48.2%
SFD/Seal	97.9%	88.9%	75.7%	59.5%	50.5%	40.8%	36.8%
DSL	96.8%	87.0%	73.7%	58.9%	50.8%		
DSL/Seal	96.0%	84.9%	69.3%	51.3%	40.9%		
EnDat2.2	93.0%	82.6%	68.3%	52.2%	43.2%		
EnDat2.2/Seal	92.2%	80.4%	63.6%	43.5%			

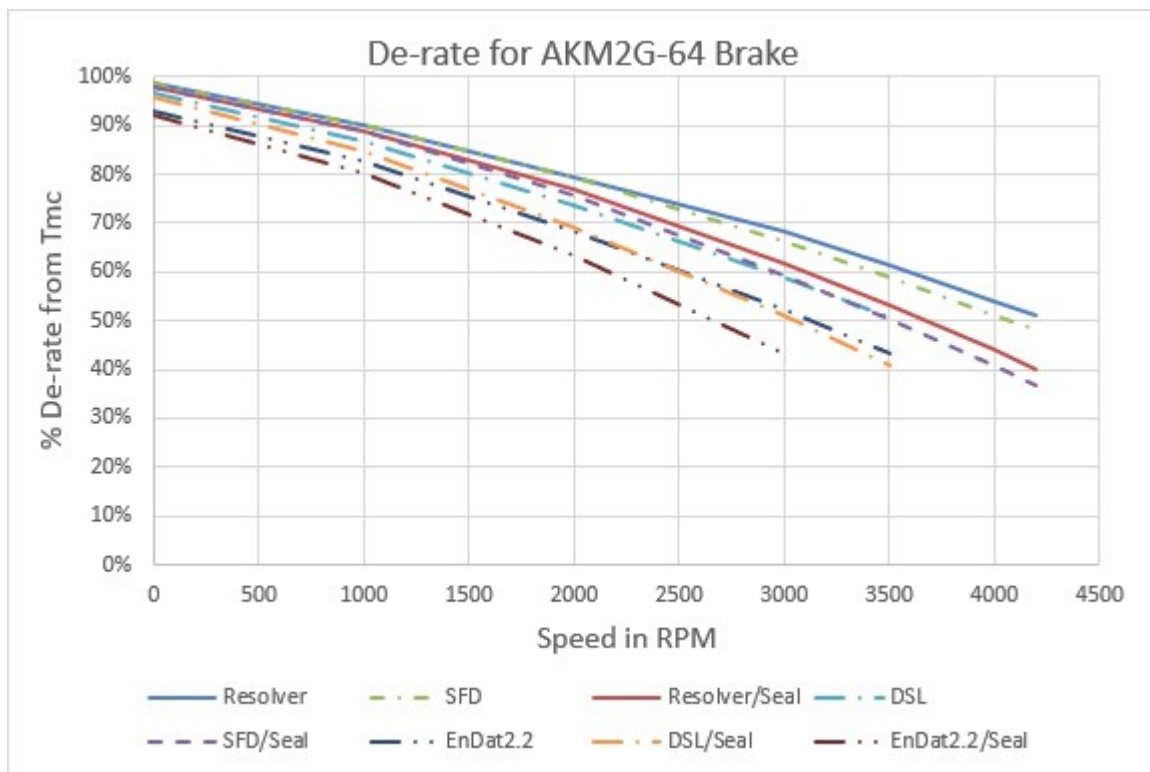

Note: For EnDat feedback motors acceleration of the motor is limited to $\leq 1 \cdot 10^5$ rad/s². The connected servo drive may further limit this value.

7.6.4 Technical Data AKM2G-65

UN	Parameter	Tolerance	Symbol	Units	AKM2G		
					65L	65M	65N
Electrical data							
	Max. Rated Equivalent Line Voltage	Max	V bus	V ac	480	480	480
	Max. Continuous Torque for ΔT winding = 100°C (1)(2)(4)	Nom	Tmc	Nm	32.6	32.6	32.7
				ib-in	289	289	289
	Max. Continuous Current for ΔT winding = 100°C (1)(2)(4)	Nom	Imc	Arms	12.4	15.3	19.0
	Max. Continuous Torque for ΔT winding = 60°C (2)(4)	Nom	Tmc	Nm	25.8	25.8	25.9
				lb-in	228	228	230
	Max. mechanical speed (5)	Nom	Nmax	rpm	6000	6000	6000
	Peak Torque (1)(2)(4)	Nom	Tp	Nm	86.8	86.8	87.0
				lb-in	768	768	770
	Peak Current	Nom	Ip	Arms	37.1	45.9	56.9
120 V AC	Rated Torque (speed) (1)(2)(4)		Trtd	Nm			
				lb-in			
	Rated Speed		Nrtd	rpm			
	Rated Power (speed) (1)(2)(4)		Prtd	kW			
Hp							
240 V AC	Rated Torque (speed) (1)(2)(4)		Trtd	Nm	31.1	30.3	29.5
				lb-in	275	268	261
	Rated Speed		Nrtd	rpm	1100	1400	1700
	Rated Power (speed) (1)(2)(4)		Prtd	kW	3.58	4.44	5.25
Hp				4.80	5.96	7.04	
400 V AC	Rated Torque (speed) (1)(2)(4)		Trtd	Nm	28.5	26.7	23.6
				lb-in	252	236	209
	Rated Speed		Nrtd	rpm	1900	2400	3100
	Rated Power (speed) (1)(2)(4)		Prtd	kW	5.67	6.71	7.67
Hp				7.60	8.99	10.28	
480 V AC	Rated Torque (speed) (1)(2)(4)		Trtd	Nm	26.8	24.3	19.6
				lb-in	237	215	173
	Rated Speed		Nrtd	rpm	2300	2900	3800
	Rated Power (speed) (1)(2)(4)		Prtd	kW	6.46	7.38	7.79
Hp				8.67	9.90	10.44	

UN	Parameter	Tolerance	Symbol	Units	AKM2G		
					65L	65M	65N
	Torque Constant (1)	+/- 10%	Kt	Nm/Arms	2.65	2.14	1.73
				lb-in/Arms	23.4	18.9	15.3
	Back EMF Constant (6)	+/- 10%	Ke	Vrms/krpm	179	144	117
	Motor Constant (1)	Nom	Km	Nm/ \sqrt{W}	2.28	2.29	2.30
				lb-in/ \sqrt{W}	20.2	20.2	20.4
	Resistance (line-line) (6)	+/- 10%	Rm	Ω	0.896	0.584	0.378
	Inductance Q-Axis (line-line)		Lqll	mH	16.4	10.7	7.0
	Inductance D-Axis (line-line)		Ldll	mH	TBD	TBD	TBD
	Inductance Saturation Current		Lisat	Arms	394	488	603
	Maximum Demagnetization Current		Midpeak	Arms	TBD	TBD	TBD

U N	Parameter	Tolerance	Symbol	Units	AKM2G		
					65L	65M	65N
Mechanical Data							
	Inertia (incl. Resolver feedback) (3)		Jm	kgcm ²	20.8		
				lb-in-s ²	1.84E-02		
	Optional Brake Inertia (additional)		Jm	kgcm ²	3.60		
				lb-in-s ²	3.19E-03		
	Weight (8)		W	kg	16.8		
				lb	37.0		
	Static Friction (1)		Tf	Nm	0.100		
				lb-in	0.885		
	Viscous Damping (1)		Kdv	Nm/krpm	0.0840		
				lb-in/krpm	0.743		
	Thermal Time Constant		TCT	mins.	75		
	Thermal Resistance		Rthw-a	°C/W	0.324		
	Pole Pairs		PP		5		
	Heatsink Size				18" x 18" x 1/2" Aluminum Plate		

1. Motor winding at temp. rise, $\delta T = 100^{\circ}\text{C}$, at 40°C ambient
2. All data referenced to sinusoidal commutation
3. Add parking brake if applicable for total inertia
4. Motor with resolver feedback and standard heat sink
5. May be limited at some values of V_{bus}
6. Measured at 25°C
7. See de-rate chart for the de-rate of different motor options.
8. Brake motor adds 4.5 kg [10lbs]
9. Shaft seal increases Static Friction by 0.12 Nm [1.06 lb-in]

Brake options are listed in chapter "Technical Data Brakes" from [Technical Data Brakes](#).

7.6.4.1 AKM2G-65 Derates for Different Options

Note: Derate information is for general estimation only. For the most accurate information for your motor use the online Performance Curve Generator located at pcgh.kollmorgen.com, the AKM2G Performance Curves document available for download at www.kollmorgen.com/sites/default/files/public_downloads/AKM2G%20Performance%20Curves_0.pdf, or refer to Kollmorgen's Motioneering Software Tool at www.kollmorgen.com/en-us/service-and-support/technical/motioneering-online/.

De-rates are referenced to the Max Continuous Torque ΔT wdg. = 100°C

Options - No Brake	Speed: RPM						
	0	1000	2000	2500	3000	3500	3800
Resolver	100.0%	91.5%	80.6%	74.9%	69.2%	63.4%	59.8%
Resolver/Seal	99.5%	90.3%	78.4%	72.2%	65.8%	59.3%	55.3%
SFD	100.0%	91.1%	78.1%	71.3%	64.2%	56.8%	52.3%
SFD/Seal	99.5%	89.4%	74.7%	66.7%	58.3%	49.4%	43.8%
DSL	96.9%	86.4%	72.4%	65.0%	57.2%	49.0%	44.0%
DSL/Seal	96.2%	84.6%	68.6%	59.9%	50.5%	40.4%	
EnDat2.2	94.6%	83.7%	69.1%	61.2%	53.0%	44.3%	38.9%
EnDat2.2/Seal	93.9%	81.8%	65.1%	55.8%	45.7%		

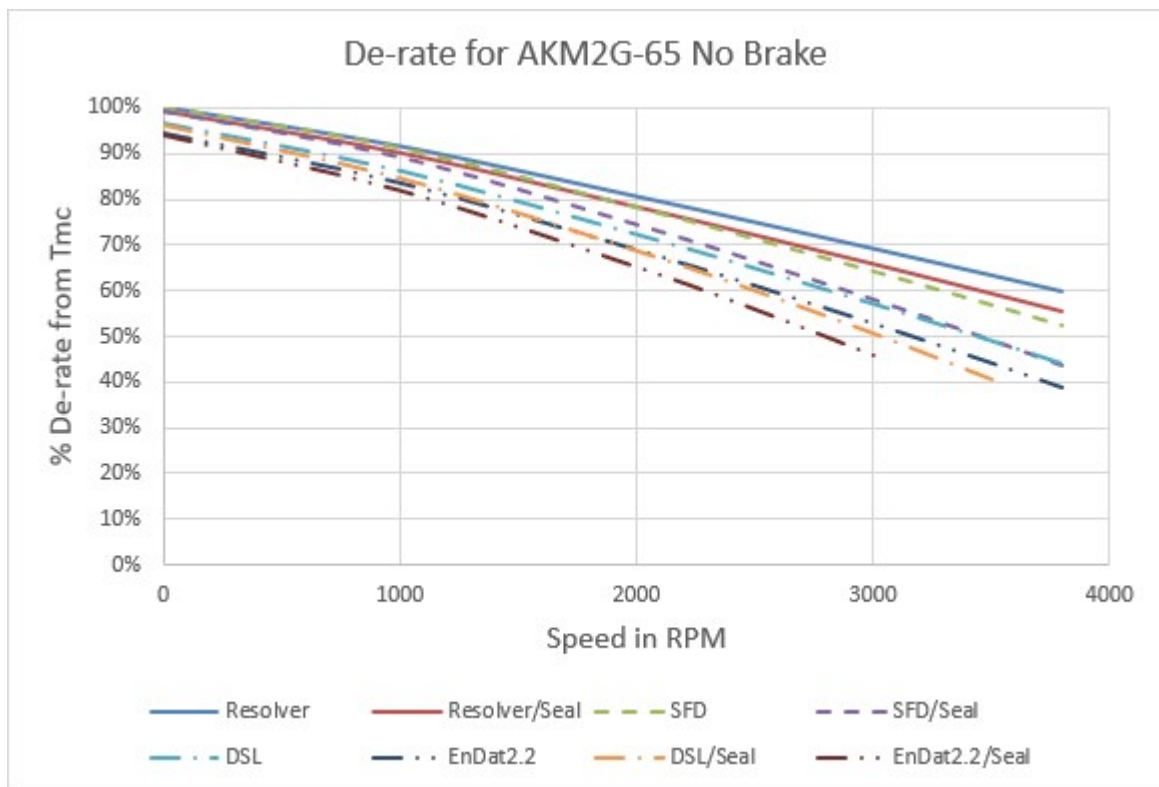

De-rates are referenced to the Max Continuous Torque ΔT wdg. = 100°C

Options - Brake	Speed: RPM						
	0	1000	2000	2500	3000	3500	3800
Resolver	98.0%	89.3%	77.2%	70.3%	63.2%	55.9%	51.3%
Resolver/Seal	97.4%	88.1%	73.7%	65.8%	57.3%	48.4%	42.8%
SFD	98.0%	88.6%	75.3%	68.3%	60.9%	53.3%	48.6%
SFD/Seal	97.4%	86.9%	71.7%	63.5%	54.8%	45.5%	39.6%
DSL	94.4%	83.6%	69.2%	61.5%	53.3%	44.8%	
DSL/Seal	93.7%	81.8%	65.2%	56.1%	46.2%		
EnDat2.2	90.6%	79.2%	63.7%	55.2%	46.3%	36.7%	
EnDat2.2/Seal	90.0%	77.2%	59.3%	49.2%	38.0%		

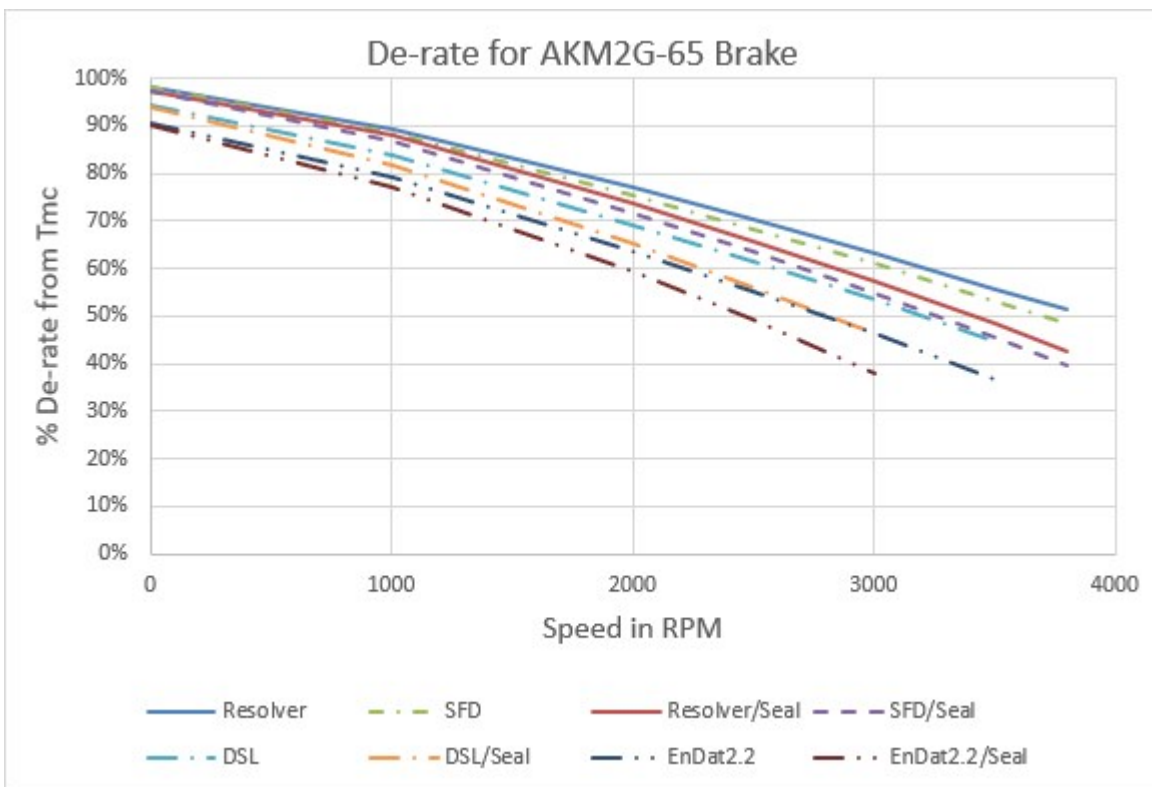

Note: For EnDat feedback motors acceleration of the motor is limited to $\leq 1 \cdot 10^5$ rad/s². The connected servo drive may further limit this value.

7.7 Technical Data AKM2G-7x Series

7.7.1 Technical Data AKM2G-71

UN	Parameter	Tolerance	Symbol	Units	AKM2G		
					71L	71N	71P
Electrical data							
	Max. Rated Equivalent Line Voltage	Max	V bus	V ac	480	480	400
	Max. Continuous Torque for ΔT winding = 100°C (1)(2)(4)	Nom	Tmc	Nm	22.9	22.8	23.0
				ib-in	202	201	204
	Max. Continuous Current for ΔT winding = 100°C (1)(2)(4)	Nom	Imc	Arms	12.1	17.3	21.1
	Max. Continuous Torque for ΔT winding = 60°C (2)(4)	Nom	Tmc	Nm	18.0	18.0	18.2
				lb-in	160	160	161
	Max. mechanical speed (5)	Nom	Nmax	rpm	6000	6000	6000
	Peak Torque (1)(2)(4)	Nom	Tp	Nm	49.5	49.3	49.8
				lb-in	438	436	440
	Peak Current	Nom	Ip	Arms	30.2	43.3	52.8
120 V AC	Rated Torque (speed) (1)(2)(4)		Trtd	Nm		22.0	21.9
				lb-in		195	193
	Rated Speed		Nrtd	rpm		1050	1300
	Rated Power (speed) (1)(2)(4)		Prtd	kW		2.42	2.97
Hp					3.25	3.99	
240 V AC	Rated Torque (speed) (1)(2)(4)		Trtd	Nm	21.2	19.9	19.0
				lb-in	188	176	168
	Rated Speed		Nrtd	rpm	1500	2200	2700
	Rated Power (speed) (1)(2)(4)		Prtd	kW	3.34	4.58	5.36
Hp				4.47	6.14	7.19	
400 V AC	Rated Torque (speed) (1)(2)(4)		Trtd	Nm	19.0	15.2	12.1
				lb-in	168	135	107
	Rated Speed		Nrtd	rpm	2600	4000	4900
	Rated Power (speed) (1)(2)(4)		Prtd	kW	5.17	6.38	6.18
Hp				6.94	8.55	8.29	
480 V AC	Rated Torque (speed) (1)(2)(4)		Trtd	Nm	17.5	12.0	
				lb-in	155	106	
	Rated Speed		Nrtd	rpm	3200	4900	
	Rated Power (speed) (1)(2)(4)		Prtd	kW	5.87	6.14	
Hp				7.87	8.23		

UN	Parameter	Tolerance	Symbol	Units	AKM2G		
					71L	71N	71P
	Torque Constant (1)	+/- 10%	Kt	Nm/Arms	1.90	1.32	1.10
				lb-in/Arms	16.9	11.7	9.7
	Back EMF Constant (6)	+/- 10%	Ke	Vrms/krpm	127	88.3	73.3
	Motor Constant (1)	Nom	Km	Nm/ \sqrt{W}	1.69	1.69	1.71
				lb-in/ \sqrt{W}	15.0	15.0	15.2
	Resistance (line-line) (6)	+/- 10%	Rm	Ω	0.845	0.407	0.274
	Inductance Q-Axis (line-line)		Lqll	mH	17.6	8.5	5.8
	Inductance D-Axis (line-line)		Ldll	mH	TBD	TBD	TBD
	Inductance Saturation Current		Lisat	Arms	86	124	149
Maximum Demagnetization Current		Midpeak	Arms	TBD	TBD	TBD	
UN	Parameter	Tolerance	Symbol	Units	AKM2G		
					71L	71N	71P
Mechanical Data							
	Inertia (incl. Resolver feedback) (3)		Jm	kgcm ²	25.9		
				lb-in-s ²	2.29E-02		
	Optional Brake Inertia (additional)		Jm	kgcm ²	12.3		
				lb-in-s ²	1.09E-02		
	Weight (8)		W	kg	16.8		
				lb	37.0		
	Static Friction (1)		Tf	Nm	0.135		
				lb-in	1.19		
	Viscous Damping (1)		Kdv	Nm/krpm	0.0865		
				lb-in/krpm	0.766		
	Thermal Time Constant		TCT	mins.	38		
	Thermal Resistance		Rthw-a	$^{\circ}C/W$	0.360		
	Pole Pairs		PP		4		
	Heatsink Size				18" x 18" x 1/2" Aluminum Plate		

1. Motor winding at temp. rise, $\delta T = 100^{\circ}C$, at $40^{\circ}C$ ambient
2. All data referenced to sinusoidal commutation
3. Add parking brake if applicable for total inertia
4. Motor with resolver feedback and standard heat sink
5. May be limited at some values of V_{bus}
6. Measured at $25^{\circ}C$
7. See de-rate chart for the de-rate of different motor options.
8. Brake motor adds 9.1 kg [20lbs]
9. Shaft seal increases Static Friction by 0.25 Nm [2.2 lb-in]
10. Rated Speed for motors equipped with a brake are limited to 3500 RPM.

Brake options are listed in chapter "Technical Data Brakes" from [Technical Data Brakes](#).

7.7.1.1 AKM2G-71 Derates for Different Options

Note: Derate information is for general estimation only. For the most accurate information for your motor use the online Performance Curve Generator located at pcgh.kollmorgen.com, the AKM2G Performance Curves document available for download at www.kollmorgen.com/sites/default/files/public_downloads/AKM2G%20Performance%20Curves_0.pdf, or refer to Kollmorgen's Motioneering Software Tool at www.kollmorgen.com/en-us/service-and-support/technical/motioneering-online/.

De-rates are referenced to the Max Continuous Torque ΔT wdg. = 100°C

Options - No Brake	Speed: RPM							
	0	1000	2000	3000	3500	4000	4500	4900
Resolver	100.0%	92.0%	82.1%	72.0%	66.9%	61.8%	56.5%	52.3%
Resolver/Seal	99.9%	91.7%	81.3%	70.9%	65.5%	60.0%	54.5%	49.9%
SFD	100.0%	92.0%	82.1%	72.0%	66.9%	61.8%	55.8%	50.9%
SFD/Seal	99.9%	91.7%	81.3%	70.9%	65.5%	59.4%	52.7%	47.2%
DSL	100.0%	92.0%	82.1%	71.7%	65.5%	59.2%	52.8%	47.6%
DSL/Seal	99.9%	91.7%	81.3%	70.0%	63.4%	56.5%	49.5%	43.7%
EnDat2.2	100.0%	92.0%	80.6%	67.9%	61.2%	54.4%		
EnDat2.2/Seal	99.9%	91.7%	79.5%	66.0%	58.9%	51.5%		

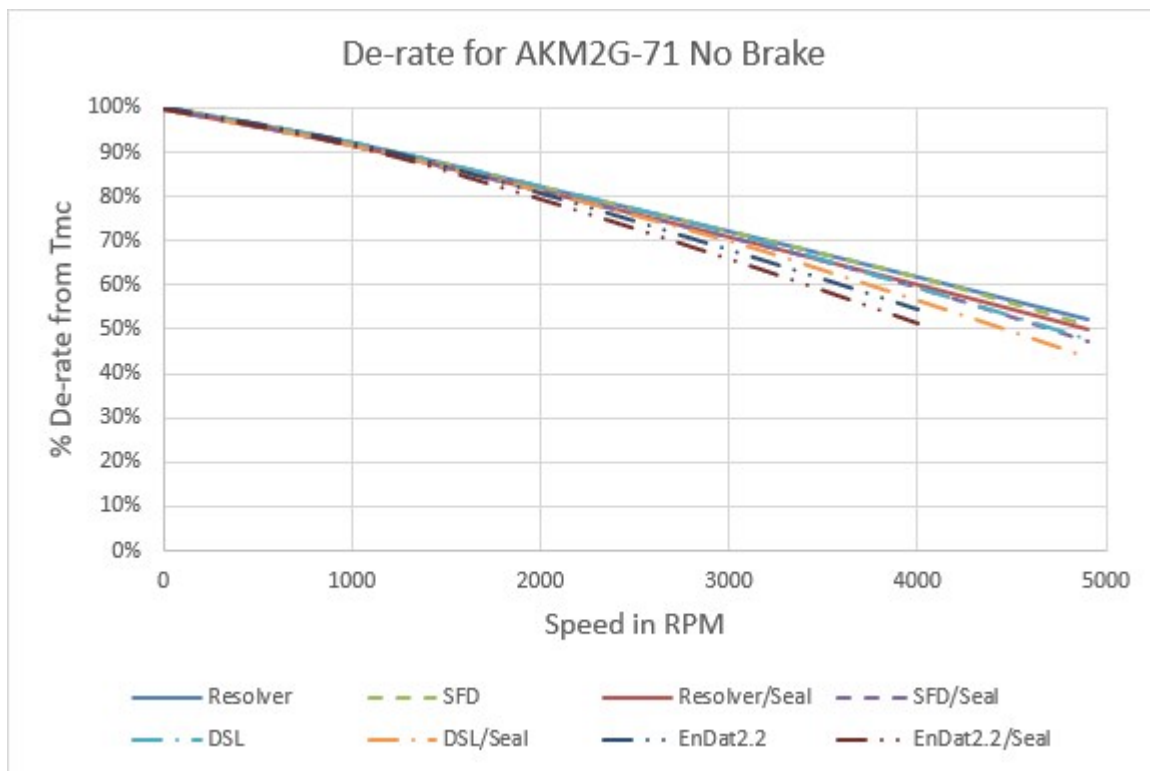

De-rates are referenced to the Max Continuous Torque ΔT wdg. = 100°C

Options - Brake	Speed: RPM				
	0	1000	2000	3000	3500
Resolver	100.0%	92.0%	82.1%	72.0%	66.9%
Resolver/Seal	99.9%	91.7%	81.3%	70.9%	65.5%
SFD	100.0%	92.0%	82.1%	72.0%	66.9%
SFD/Seal	99.9%	91.7%	81.3%	70.9%	65.5%
DSL	100.0%	92.0%	82.1%	69.7%	63.2%
DSL/Seal	99.9%	91.7%	81.1%	67.9%	61.0%
EnDat2.2	100.0%	90.9%	78.0%	64.6%	57.5%
EnDat2.2/Seal	99.9%	90.4%	76.9%	62.6%	55.0%

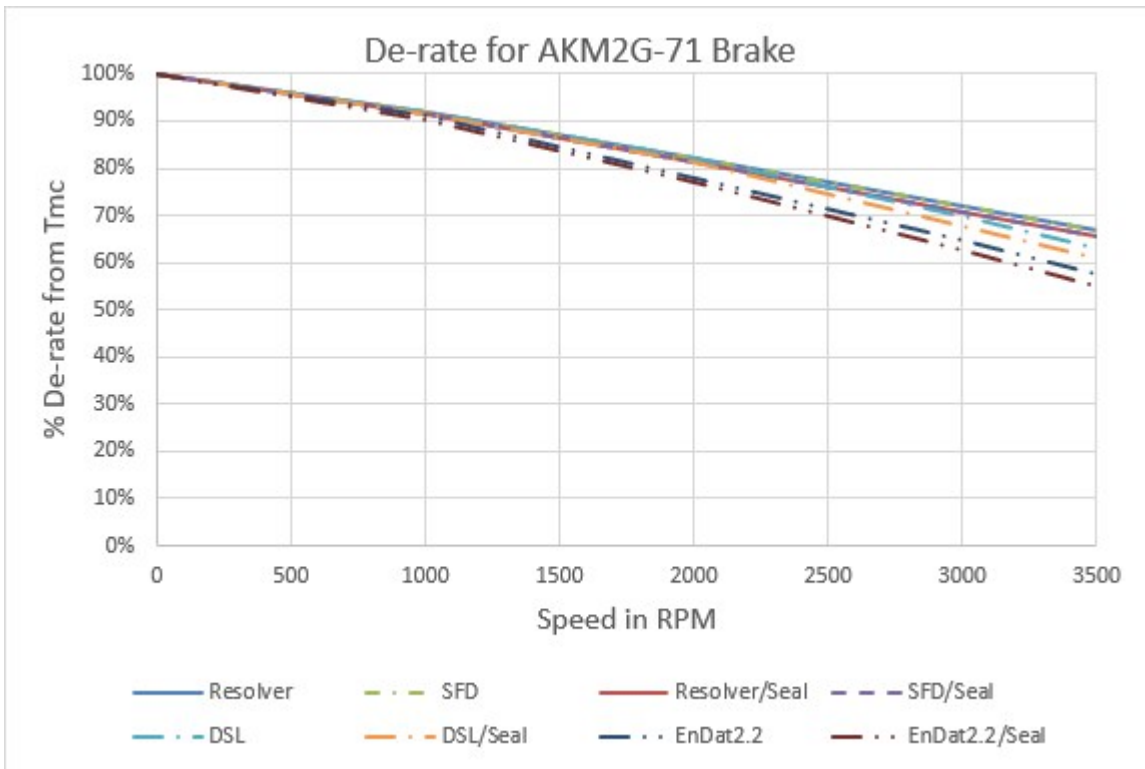

Note: For EnDat feedback motors acceleration of the motor is limited to $\leq 1 \cdot 10^5$ rad/s². The connected servo drive may further limit this value.

7.7.2 Technical Data AKM2G-72

UN	Parameter	Tolerance	Symbol	Units	AKM2G		
					72L	72N	72P
Electrical data							
	Max. Rated Equivalent Line Voltage	Max	V bus	V ac	480	480	480
	Max. Continuous Torque for ΔT winding = 100°C (1)(2)(4)	Nom	Tmc	Nm	40.5	41.1	40.7
				lb-in	359	364	360
	Max. Continuous Current for ΔT winding = 100°C (1)(2)(4)	Nom	Imc	Arms	12.3	18.7	21.2
	Max. Continuous Torque for ΔT winding = 60°C (2)(4)	Nom	Tmc	Nm	32.0	32.7	32.4
				lb-in	284	289	287
	Max. mechanical speed (5)	Nom	Nmax	rpm	6000	6000	6000
	Peak Torque (1)(2)(4)	Nom	Tp	Nm	89.3	90.4	89.6
				lb-in	791	800	793
	Peak Current	Nom	Ip	Arms	30.8	46.9	53.0
120 V AC	Rated Torque (speed) (1)(2)(4)		Trtd	Nm			
				lb-in			
	Rated Speed		Nrtd	rpm			
	Rated Power (speed) (1)(2)(4)		Prtd	kW			
Hp							
240 V AC	Rated Torque (speed) (1)(2)(4)		Trtd	Nm	38.7	37.4	36.1
				lb-in	342	331	319
	Rated Speed		Nrtd	rpm	900	1400	1600
	Rated Power (speed) (1)(2)(4)		Prtd	kW	3.64	5.48	6.05
Hp				4.89	7.35	8.11	
400 V AC	Rated Torque (speed) (1)(2)(4)		Trtd	Nm	36.1	31.9	29.0
				lb-in	319	283	257
	Rated Speed		Nrtd	rpm	1550	2400	2800
	Rated Power (speed) (1)(2)(4)		Prtd	kW	5.86	8.03	8.51
Hp				7.85	10.8	11.4	
480 V AC	Rated Torque (speed) (1)(2)(4)		Trtd	Nm	34.2	28.4	24.2
				lb-in	303	251	215
	Rated Speed		Nrtd	rpm	1900	2900	3400
	Rated Power (speed) (1)(2)(4)		Prtd	kW	6.81	8.63	8.63
Hp				9.13	11.6	11.6	

UN	Parameter	Tolerance	Symbol	Units	AKM2G		
					72L	72N	72P
	Torque Constant (1)	+/- 10%	Kt	Nm/Arms	3.31	2.20	1.93
				lb-in/Arms	29.3	19.5	17.0
	Back EMF Constant (6)	+/- 10%	Ke	Vrms/krpm	221	147	129
	Motor Constant (1)	Nom	Km	Nm/ \sqrt{W}	2.77	2.83	2.80
				lb-in/ \sqrt{W}	24.5	25.0	24.8
	Resistance (line-line) (6)	+/- 10%	Rm	Ω	0.950	0.405	0.315
	Inductance Q-Axis (line-line)		Lqll	mH	22.6	10.0	7.7
	Inductance D-Axis (line-line)		Ldll	mH	TBD	TBD	TBD
	Inductance Saturation Current		Lisat	Arms	100	149	171
Maximum Demagnetization Current		Midpeak	Arms	TBD	TBD	TBD	

U N	Parameter	Tolerance	Symbol	Units	AKM2G		
					72L	72N	72P
Mechanical Data							
	Inertia (incl. Resolver feedback) (3)		Jm	kgcm ²	46.8		
				lb-in-s ²	4.14E-02		
	Optional Brake Inertia (additional)		Jm	kgcm ²	12.3		
				lb-in-s ²	1.09E-02		
	Weight (8)		W	kg	22.9		
				lb	50.5		
	Static Friction (1)		Tf	Nm	0.158		
				lb-in	1.40		
	Viscous Damping (1)		Kdv	Nm/krpm	0.173		
				lb-in/krpm	1.53		
	Thermal Time Constant		TCT	mins.	43		
	Thermal Resistance		Rthw-a	°C/W	0.307		
	Pole Pairs		PP		4		
	Heatsink Size				18" x 18" x 1/2" Aluminum Plate		

1. Motor winding at temp. rise, $\delta T = 100^{\circ}\text{C}$, at 40°C ambient
2. All data referenced to sinusoidal commutation
3. Add parking brake if applicable for total inertia
4. Motor with resolver feedback and standard heat sink
5. May be limited at some values of V_{bus}
6. Measured at 25°C
7. See de-rate chart for the de-rate of different motor options.
8. Brake motor adds 9.1 kg [20lbs]
9. Shaft seal increases Static Friction by 0.25 Nm [2.2 lb-in]
10. Rated Speed for motors equipped with a brake are limited to 3500 RPM.

Brake options are listed in chapter "Technical Data Brakes" from [Technical Data Brakes](#).

7.7.2.1 AKM2G-72 Derates for Different Options

Note: Derate information is for general estimation only. For the most accurate information for your motor use the online Performance Curve Generator located at pcgh.kollmorgen.com, the AKM2G Performance Curves document available for download at www.kollmorgen.com/sites/default/files/public_downloads/AKM2G%20Performance%20Curves_0.pdf, or refer to Kollmorgen's Motioneering Software Tool at www.kollmorgen.com/en-us/service-and-support/technical/motioneering-online/.

De-rates are referenced to the Max Continuous Torque ΔT wdg. = 100°C

Options - No Brake	Speed: RPM						
	0	1000	1500	2000	2500	3000	3400
Resolver	100.0%	89.7%	83.3%	77.0%	70.7%	64.5%	59.6%
Resolver/Seal	99.9%	89.3%	82.8%	76.3%	69.8%	63.4%	58.3%
SFD	100.0%	89.7%	83.3%	77.0%	70.7%	64.5%	59.5%
SFD/Seal	99.9%	89.3%	82.8%	76.3%	69.8%	63.4%	57.6%
DSL	100.0%	89.7%	83.3%	77.0%	69.6%	62.3%	56.6%
DSL/Seal	99.9%	89.3%	82.8%	76.1%	68.3%	60.7%	54.7%
EnDat2.2	100.0%	89.3%	81.4%	73.4%	65.6%	57.8%	51.7%
EnDat2.2/Seal	99.9%	88.9%	80.7%	72.5%	64.3%	56.0%	49.5%

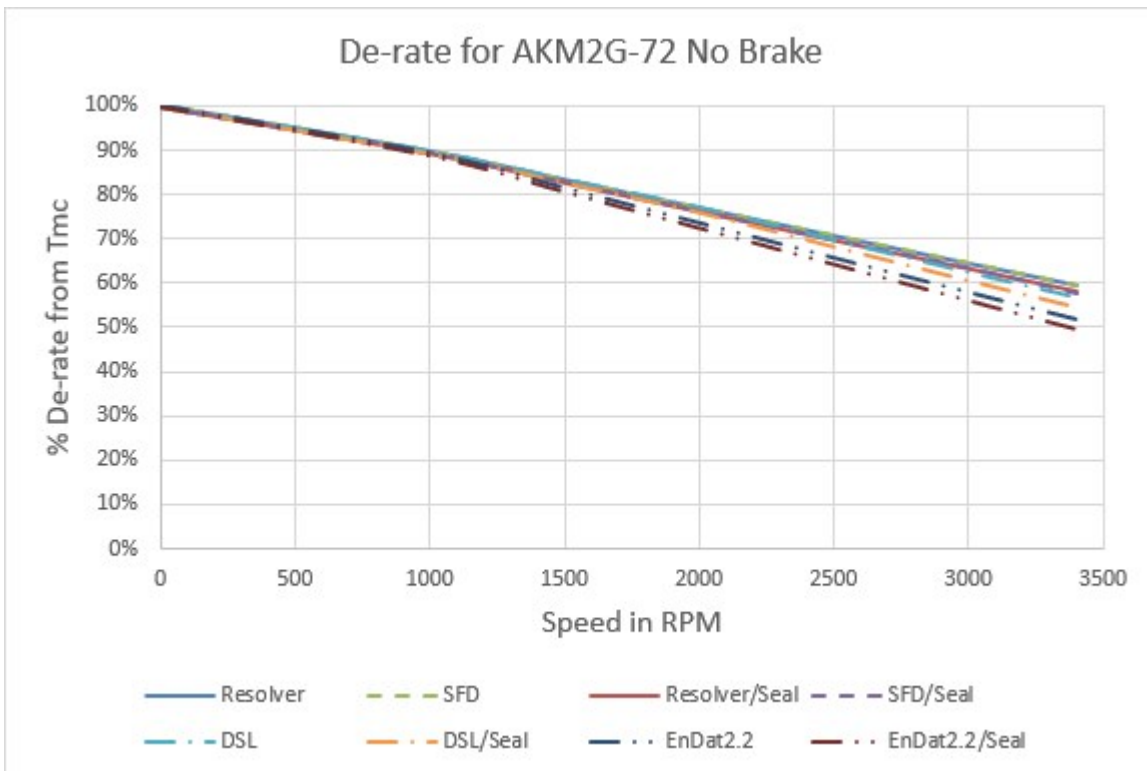

De-rates are referenced to the Max Continuous Torque ΔT wdg. = 100°C

Options - Brake	Speed: RPM						
	0	1000	1500	2000	2500	3000	3400
Resolver	100.0%	89.7%	83.3%	77.0%	70.7%	64.5%	59.6%
Resolver/Seal	99.9%	89.3%	82.8%	76.3%	69.8%	63.4%	58.3%
SFD	100.0%	89.7%	83.3%	77.0%	70.7%	64.5%	59.5%
SFD/Seal	99.9%	89.3%	82.8%	76.3%	69.8%	63.4%	57.6%
DSL	100.0%	89.7%	83.3%	75.7%	68.0%	60.5%	54.7%
DSL/Seal	99.9%	89.3%	82.7%	74.8%	66.8%	58.9%	52.7%
EnDat2.2	100.0%	87.6%	79.3%	71.1%	62.9%	54.7%	48.2%
EnDat2.2/Seal	99.9%	87.1%	78.7%	70.1%	61.5%	52.8%	45.9%

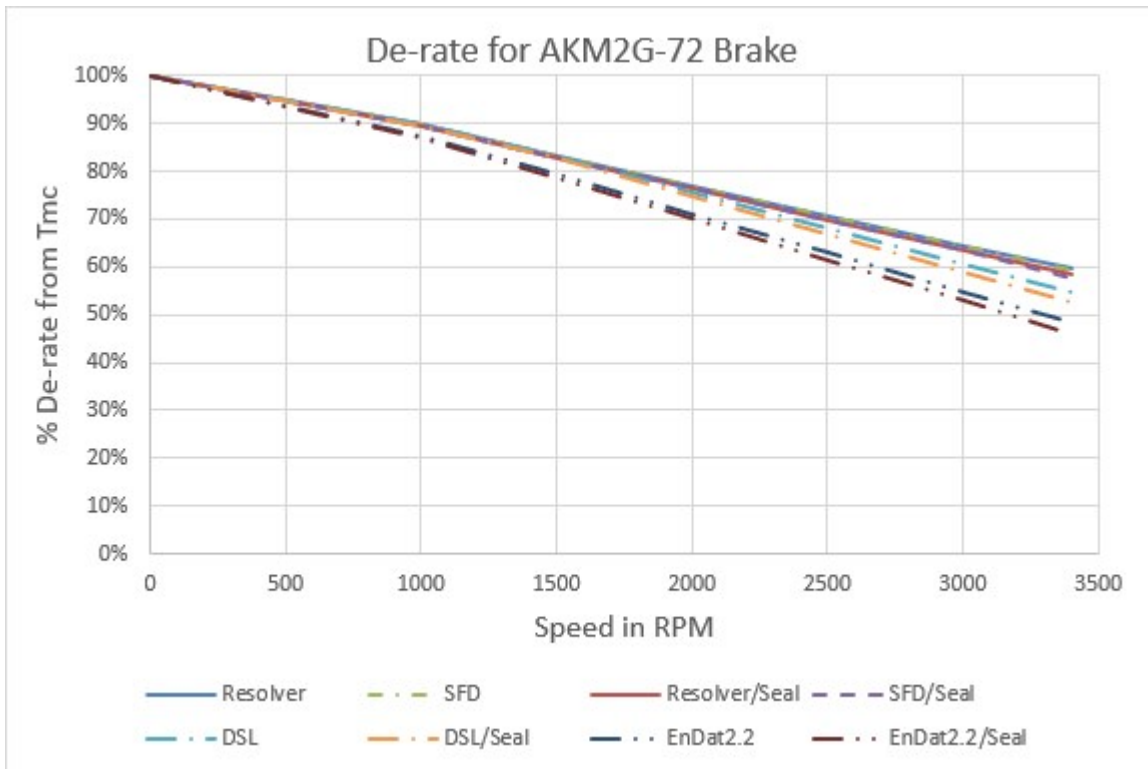

Note: For EnDat feedback motors acceleration of the motor is limited to $\leq 1 \cdot 10^5$ rad/s². The connected servo drive may further limit this value.

7.7.3 Technical Data AKM2G-73

UN	Parameter	Tolerance	Symbol	Units	AKM2G		
					73L	73N	73Q
Electrical data							
	Max. Rated Equivalent Line Voltage	Max	V bus	V ac	480	480	480
	Max. Continuous Torque for ΔT winding = 100°C (1)(2)(4)	Nom	Tmc	Nm	56.6	57.9	57.1
				ib-in	501	512	505
	Max. Continuous Current for ΔT winding = 100°C (1)(2)(4)	Nom	Imc	Arms	11.6	17.6	27.4
	Max. Continuous Torque for ΔT winding = 60°C (2)(4)	Nom	Tmc	Nm	44.7	45.9	45.6
				lb-in	396	406	404
	Max. mechanical speed (5)	Nom	Nmax	rpm	6000	6000	6000
	Peak Torque (1)(2)(4)	Nom	Tp	Nm	127.3	129.6	128.1
				lb-in	1127	1147	1134
	Peak Current	Nom	Ip	Arms	29.0	43.9	68.5
120 V AC	Rated Torque (speed) (1)(2)(4)		Trtd	Nm			
				lb-in			
	Rated Speed		Nrtd	rpm			
	Rated Power (speed) (1)(2)(4)		Prtd	kW			
Hp							
240 V AC	Rated Torque (speed) (1)(2)(4)		Trtd	Nm		54.6	50.0
				lb-in		484	442
	Rated Speed		Nrtd	rpm		900	1500
	Rated Power (speed) (1)(2)(4)		Prtd	kW		5.15	7.85
Hp					6.91	10.5	
400 V AC	Rated Torque (speed) (1)(2)(4)		Trtd	Nm	52.5	49.5	38.9
				lb-in	465	438	344
	Rated Speed		Nrtd	rpm	1050	1600	2600
	Rated Power (speed) (1)(2)(4)		Prtd	kW	5.77	8.29	10.6
Hp				7.74	11.1	14.2	
480 V AC	Rated Torque (speed) (1)(2)(4)		Trtd	Nm	50.6	46.6	30.8
				lb-in	448	412	273
	Rated Speed		Nrtd	rpm	1300	1900	3200
	Rated Power (speed) (1)(2)(4)		Prtd	kW	6.89	9.3	10.3
Hp				9.24	12.4	13.9	

UN	Parameter	Tolerance	Symbol	Units	AKM2G		
					73L	73N	73Q
	Torque Constant (1)	+/- 10%	Kt	Nm/Arms	4.90	3.30	2.09
				lb-in/Arms	43.3	29.2	18.5
	Back EMF Constant (6)	+/- 10%	Ke	Vrms/krpm	328	221	140
	Motor Constant (1)	Nom	Km	Nm/ \sqrt{W}	3.59	3.68	3.66
				lb-in/ \sqrt{W}	31.7	32.6	32.4
	Resistance (line-line) (6)	+/- 10%	Rm	Ω	1.24	0.537	0.217
	Inductance Q-Axis (line-line)		Lqll	mH	31.2	14.2	5.7
	Inductance D-Axis (line-line)		Ldll	mH	TBD	TBD	TBD
	Inductance Saturation Current		Lisat	Arms	101	149	236
	Maximum Demagnetization Current		Midpeak	Arms	TBD	TBD	TBD

U N	Parameter	Tolerance	Symbol	Units	AKM2G		
					73L	73N	73Q
Mechanical Data							
	Inertia (incl. Resolver feedback) (3)		Jm	kgcm ²	67.7		
				lb-in-s ²	5.99E-02		
	Optional Brake Inertia (additional)		Jm	kgcm ²	12.3		
				lb-in-s ²	1.09E-02		
	Weight (8)		W	kg	29.0		
				lb	64.0		
	Static Friction (1)		Tf	Nm	0.236		
				lb-in	2.09		
	Viscous Damping (1)		Kdv	Nm/krpm	0.260		
				lb-in/krpm	2.30		
	Thermal Time Constant		TCT	mins.	49		
	Thermal Resistance		Rthw-a	°C/W	0.264		
	Pole Pairs		PP		4		
	Heatsink Size				18" x 18" x 1/2" Aluminum Plate		

1. Motor winding at temp. rise, $\delta T = 100^{\circ}\text{C}$, at 40°C ambient
2. All data referenced to sinusoidal commutation
3. Add parking brake if applicable for total inertia
4. Motor with resolver feedback and standard heat sink
5. May be limited at some values of V_{bus}
6. Measured at 25°C
7. See de-rate chart for the de-rate of different motor options.
8. Brake motor adds 9.1 kg [20lbs]
9. Shaft seal increases Static Friction by 0.25 Nm [2.2 lb-in]
10. Rated Speed for motors equipped with a brake are limited to 3500 RPM.

Brake options are listed in chapter "Technical Data Brakes" from [Technical Data Brakes](#).

7.7.3.1 AKM2G-73 Derates for Different Options

Note: Derate information is for general estimation only. For the most accurate information for your motor use the online Performance Curve Generator located at pcgh.kollmorgen.com, the AKM2G Performance Curves document available for download at www.kollmorgen.com/sites/default/files/public_downloads/AKM2G%20Performance%20Curves_0.pdf, or refer to Kollmorgen's Motioneering Software Tool at www.kollmorgen.com/en-us/service-and-support/technical/motioneering-online/.

De-rates are referenced to the Max Continuous Torque ΔT wdg. = 100°C

Options - No Brake	Speed: RPM						
	0	1000	1500	2000	2500	3000	3200
Resolver	100.0%	87.3%	79.5%	71.8%	64.3%	56.9%	54.0%
Resolver/Seal	99.9%	87.1%	79.1%	71.2%	63.5%	55.8%	52.8%
SFD	100.0%	87.3%	79.5%	71.8%	62.8%	53.9%	50.5%
SFD/Seal	99.9%	87.1%	79.1%	71.1%	61.7%	52.4%	48.8%
DSL	100.0%	87.3%	79.1%	69.5%	60.0%	50.7%	47.0%
DSL/Seal	99.9%	87.1%	78.6%	68.7%	58.8%	49.1%	45.2%
EnDat2.2	100.0%	85.7%	75.6%	65.5%	55.2%	45.0%	
EnDat2.2/Seal	99.9%	85.3%	75.0%	64.6%	53.9%	43.2%	

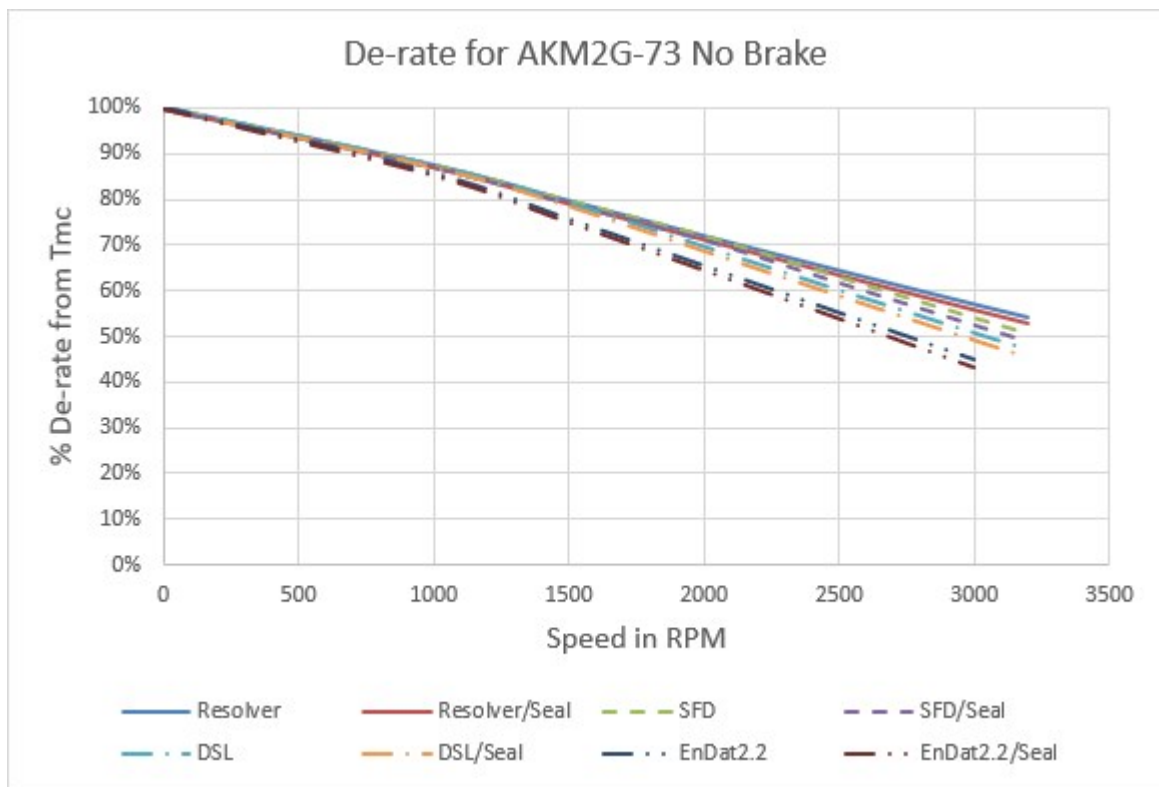

De-rates are referenced to the Max Continuous Torque ΔT wdg. = 100°C

Options - Brake	Speed: RPM						
	0	1000	1500	2000	2500	3000	3200
Resolver	100.0%	87.3%	79.5%	71.8%	64.3%	56.6%	53.3%
Resolver/Seal	99.9%	87.1%	79.1%	71.2%	63.5%	55.2%	51.7%
SFD	100.0%	87.3%	79.5%	71.8%	62.8%	53.9%	50.5%
SFD/Seal	99.9%	87.1%	79.1%	71.1%	61.7%	52.4%	48.8%
DSL	100.0%	87.3%	77.7%	67.8%	58.0%	48.3%	44.5%
DSL/Seal	99.9%	87.1%	77.1%	67.0%	56.8%	46.6%	42.6%
EnDat2.2	100.0%	83.7%	73.3%	62.6%	51.8%	40.9%	
EnDat2.2/Seal	99.9%	83.3%	72.7%	61.7%	50.5%	38.9%	

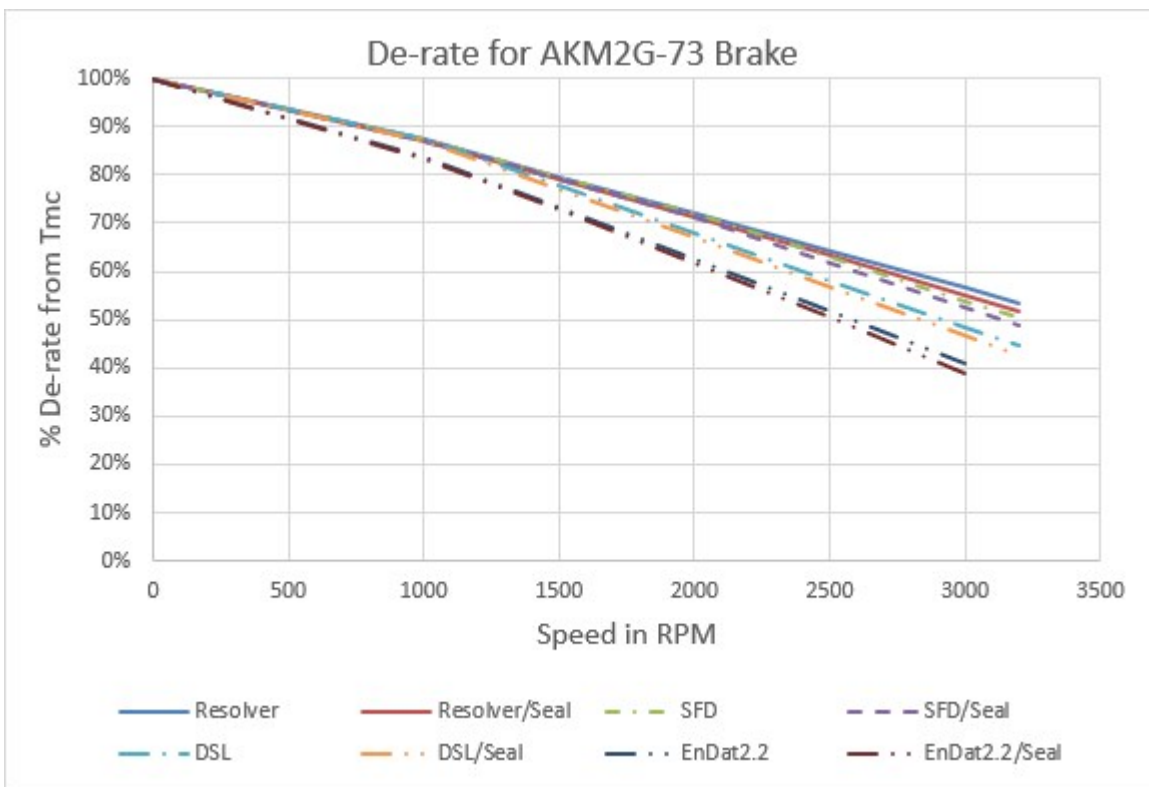

Note: For EnDat feedback motors acceleration of the motor is limited to $\leq 1 \cdot 10^5$ rad/s². The connected servo drive may further limit this value.

7.7.4 Technical Data AKM2G-74

UN	Parameter	Tolerance	Symbol	Units	AKM2G		
					74P	74Q	74R
Electrical data							
	Max. Rated Equivalent Line Voltage	Max	V bus	V ac	480	480	480
	Max. Continuous Torque for ΔT winding = 100°C (1)(2)(4)	Nom	Tmc	Nm	72.2	71.7	71.3
				ib-in	639	635	631
	Max. Continuous Current for ΔT winding = 100°C (1)(2)(4)	Nom	Imc	Arms	23.1	28.8	32.5
	Max. Continuous Torque for ΔT winding = 60°C (2)(4)	Nom	Tmc	Nm	57.7	57.7	57.5
				lb-in	511	510	509
	Max. mechanical speed (5)	Nom	Nmax	rpm	6000	6000	6000
	Peak Torque (1)(2)(4)	Nom	Tp	Nm	164.6	163.8	162.9
				lb-in	1457	1450	1442
	Peak Current	Nom	Ip	Arms	57.8	72.1	81.1
120 V AC	Rated Torque (speed) (1)(2)(4)		Trtd	Nm			
				lb-in			
	Rated Speed		Nrtd	rpm			
	Rated Power (speed) (1)(2)(4)		Prtd	kW			
Hp							
240 V AC	Rated Torque (speed) (1)(2)(4)		Trtd	Nm	66.5	64.0	61.5
				lb-in	589	566	544
	Rated Speed		Nrtd	rpm	1000	1250	1450
	Rated Power (speed) (1)(2)(4)		Prtd	kW	6.96	8.37	9.34
Hp				9.34	11.2	12.5	
400 V AC	Rated Torque (speed) (1)(2)(4)		Trtd	Nm	58.1	50.7	45.1
				lb-in	514	448	399
	Rated Speed		Nrtd	rpm	1700	2200	2500
	Rated Power (speed) (1)(2)(4)		Prtd	kW	10.3	11.7	11.8
Hp				13.9	15.7	15.8	
480 V AC	Rated Torque (speed) (1)(2)(4)		Trtd	Nm	52.4	41.7	34.0
				lb-in	464	369	301
	Rated Speed		Nrtd	rpm	2100	2700	3000
	Rated Power (speed) (1)(2)(4)		Prtd	kW	11.5	11.8	10.7
Hp				15.5	15.8	14.3	

UN	Parameter	Tolerance	Symbol	Units	AKM2G		
					74P	74Q	74R
	Torque Constant (1)	+/- 10%	Kt	Nm/Arms	3.14	2.50	2.21
				lb-in/Arms	27.8	22.1	19.5
	Back EMF Constant (6)	+/- 10%	Ke	Vrms/krpm	210	167	148
	Motor Constant (1)	Nom	Km	Nm/ \sqrt{W}	4.39	4.38	4.37
				lb-in/ \sqrt{W}	38.8	38.8	38.7
	Resistance (line-line) (6)	+/- 10%	Rm	Ω	0.341	0.217	0.170
	Inductance Q-Axis (line-line)		Lqll	mH	9.2	5.9	4.6
	Inductance D-Axis (line-line)		Ldll	mH	TBD	TBD	TBD
	Inductance Saturation Current		Lisat	Arms	210	264	299
Maximum Demagnetization Current		Midpeak	Arms	TBD	TBD	TBD	

U N	Parameter	Tolerance	Symbol	Units	AKM2G		
					74P	74Q	74R
Mechanical Data							
	Inertia (incl. Resolver feedback) (3)		Jm	kgcm ²	88.6		
				lb-in-s ²	7.84E-02		
	Optional Brake Inertia (additional)		Jm	kgcm ²	12.3		
				lb-in-s ²	1.09E-02		
	Weight (8)		W	kg	35.2		
				lb	77.5		
	Static Friction (1)		Tf	Nm	0.315		
				lb-in	2.79		
	Viscous Damping (1)		Kdv	Nm/krpm	0.346		
				lb-in/krpm	3.06		
	Thermal Time Constant		TCT	mins.	56		
	Thermal Resistance		Rthw-a	°C/W	0.237		
	Pole Pairs		PP		4		
	Heatsink Size				18" x 18" x 1/2" Aluminum Plate		

1. Motor winding at temp. rise, $\delta T = 100^{\circ}\text{C}$, at 40°C ambient
2. All data referenced to sinusoidal commutation
3. Add parking brake if applicable for total inertia
4. Motor with resolver feedback and standard heat sink
5. May be limited at some values of V_{bus}
6. Measured at 25°C
7. See de-rate chart for the de-rate of different motor options.
8. Brake motor adds 9.1 kg [20lbs]
9. Shaft seal increases Static Friction by 0.25 Nm [2.2 lb-in]
10. Rated Speed for motors equipped with a brake are limited to 3500 RPM.

Brake options are listed in chapter "Technical Data Brakes" from [Technical Data Brakes](#).

7.7.4.1 AKM2G-74 Derates for Different Options

Note: Derate information is for general estimation only. For the most accurate information for your motor use the online Performance Curve Generator located at pcgh.kollmorgen.com, the AKM2G Performance Curves document available for download at www.kollmorgen.com/sites/default/files/public_downloads/AKM2G%20Performance%20Curves_0.pdf, or refer to Kollmorgen's Motioneering Software Tool at www.kollmorgen.com/en-us/service-and-support/technical/motioneering-online/.

De-rates are referenced to the Max Continuous Torque ΔT wdg. = 100°C

Options - No Brake	Speed: RPM						
	0	500	1000	1500	2000	2500	3000
Resolver	100.0%	94.4%	85.0%	75.6%	66.2%	56.8%	47.6%
Resolver/Seal	99.9%	94.2%	84.7%	75.2%	65.6%	56.0%	46.5%
SFD	100.0%	94.4%	85.0%	75.6%	65.6%	54.6%	44.0%
SFD/Seal	99.9%	94.2%	84.7%	75.2%	64.9%	53.5%	42.4%
DSL	100.0%	94.4%	85.0%	74.4%	62.9%	51.4%	
DSL/Seal	99.9%	94.2%	84.7%	73.9%	62.1%	50.2%	
EnDat2.2	100.0%	94.2%	82.6%	70.6%	58.3%	45.7%	
EnDat2.2/Seal	99.9%	94.1%	82.2%	70.0%	57.4%	44.4%	

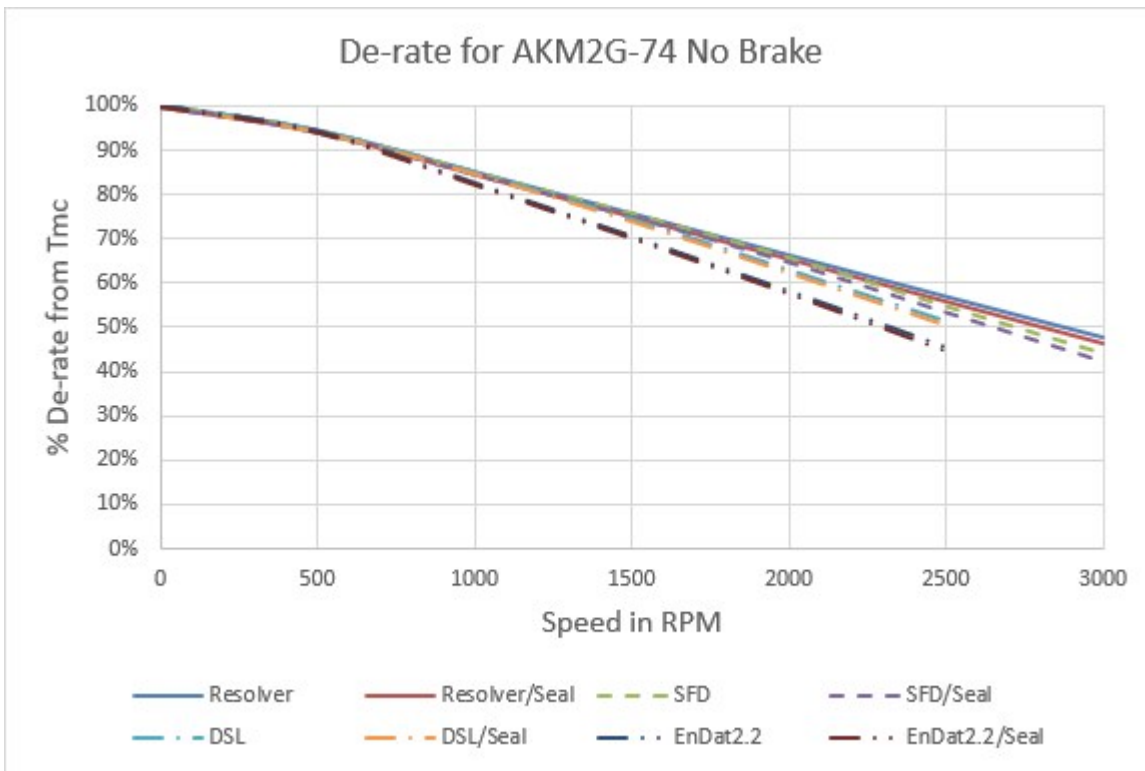

De-rates are referenced to the Max Continuous Torque ΔT wdg. = 100°C

Options - Brake	Speed: RPM						
	0	500	1000	1500	2000	2500	3000
Resolver	99.6%	93.9%	84.5%	75.1%	65.6%	56.0%	45.6%
Resolver/Seal	99.5%	93.8%	84.2%	74.7%	65.0%	54.9%	44.2%
SFD	99.6%	93.9%	84.5%	75.1%	64.6%	53.4%	42.5%
SFD/Seal	99.5%	93.8%	84.2%	74.7%	63.8%	52.3%	40.9%
DSL	99.6%	93.9%	83.6%	71.9%	59.9%	47.7%	
DSL/Seal	99.5%	93.8%	83.3%	71.3%	59.0%	46.4%	
EnDat2.2	98.9%	91.8%	79.6%	67.1%	54.0%	40.2%	
EnDat2.2/Seal	98.9%	91.7%	79.3%	66.5%	53.0%	38.7%	

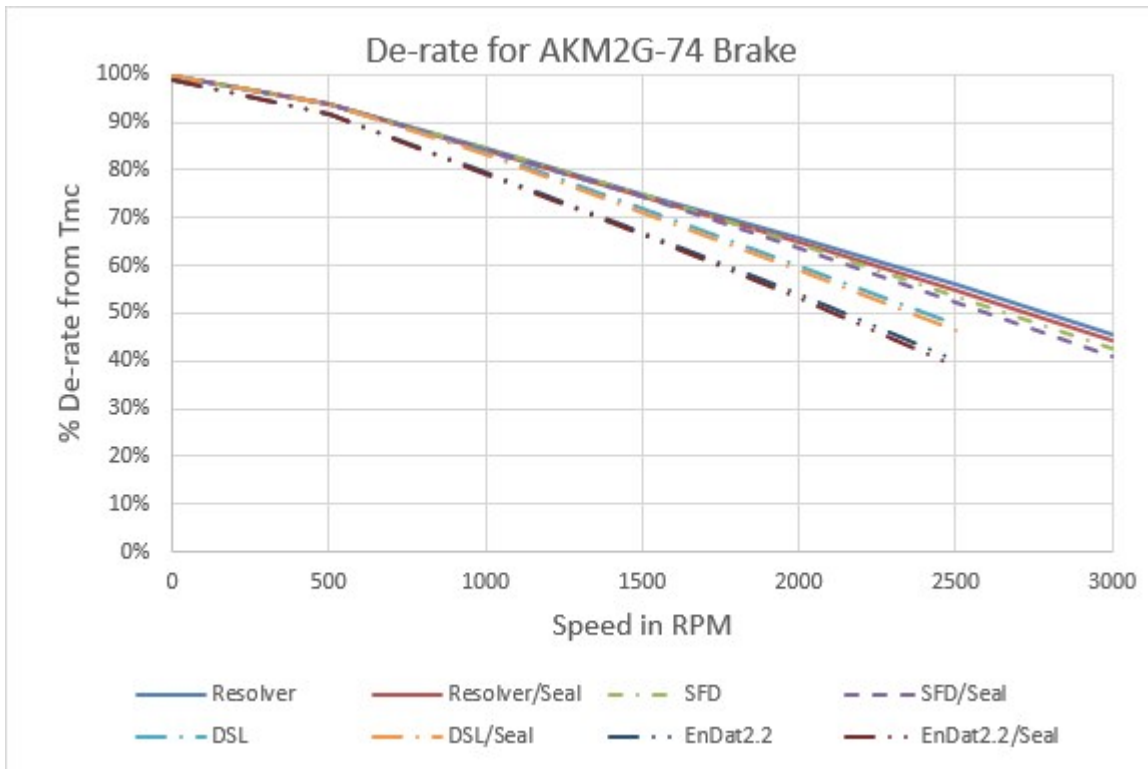

Note: For EnDat feedback motors acceleration of the motor is limited to $\leq 1 \cdot 10^5$ rad/s². The connected servo drive may further limit this value.

7.8 Technical Data Brakes

FAILSAFE, HOLDING BRAKE

The holding brake is designed to provide static holding torque to the motor shaft with the brake coil de-energized. The brake must first be released (coil energized) prior to commanding motor rotation as determined by its drop-out time. The brake is intended for holding or “parking” of a stationary motor. It is not intended for dynamic braking. There should be absolutely no motion of the rotor when power is removed from the brake coil.

It may be used for a limited number of emergency stop conditions, however such use will eventually cause wear, leading to eventual malfunction of the brake. Number of emergency stops strongly depends on applied load. Contact Kollmorgen for proper calculation of energy that needs to be absorbed during emergency stops in application.

Contamination of the motor internal compartment by oil or other foreign materials will result in failure of the brake. Check the suitability of motor sealing for the working environment.

Motor Family	-	AKM2G2	AKM2G3	AKM2G4	AKM2G5	AKM2G6	AKM2G7	Notes
Nominal Operating Voltage	VDC ±10%	24						
Minimum Dry Static Torque, 120°C	Nm	2.0	3.3	7.0	16.0	32.0	80.0	1
Maximum Speed	rpm	8000	8000	6000	6000	6000	3500	
Maximum Acceleration	rad/s ²	56000	28500	23000	14000	9000	4000	11,12
Coil Resistance, 25°C	Ω ±7%	50.5	45.7	39.1	27.7	19.5	15.0	
Maximum Release Voltage (New Brake)	VDC	18						2,14
Minimum Re-Engage Voltage (New Brake)	VDC	≥1.5						3,14
Current @24V, 25°C	ADC	0.47	0.53	0.61	0.87	1.23	1.65	10
Maximum Release Current (New Brake), 25°C	ADC	0.54	0.60	0.70	0.99	1.40	1.85	
Power Consumption @24V, 25°C	Watt ±7%	11.4	12.6	14.7	20.8	29.5	40	
Response (Engage/Closing) Time w/ AKD	ms	25	35	50	80	90	120	6,8,9
Release (Opening) Time w/ AKD	ms	40	55	85	135	150	300	6,7
Total Torque Rise Time w/ AKD	ms	50	55	95	170	265	310	15, 16
Maximum Backlash	deg.	1.0	1.0	1.0	1.0	1.0	1.0	4,5,12
Typical Backlash	deg.	0.30	0.60	0.55	0.60	0.30	0.20	4,5,12
Inertia Adder	kg.cm ²	0.04	0.12	0.36	1.2	3.6	12.3	
Weight Adder	kg	0.45	0.72	1.36	2.6	4.5	9.1	
B _{10d}	-	20.000.000				12.000.000		13
Temperature Range	°C	+5°C to 120°C						

Please contact Kollmorgen for detailed specification and all other inquiries.

Notes:

Note 1: Minimum Dry Static Torque - max. torque that can be applied to a brake without the risk of slipping.

Note 2: Maximum Release Voltage - value of voltage where the brake is 100% OPEN. The brake is mounted inside of the motor.

Note 3: Minimum Re-Engage Voltage - value of voltage where the brake is 100% CLOSED. The brake is mounted inside of the motor.

Note 4: Backlash - amount of clearance, or free rotation, from a point based in one direction to a point in the opposite direction with torque applied, between the drive connection of the brake to the motor shaft. 25% of the rated torque of the brake can be applied during the backlash measurement.

Note 5: Maximum Backlash is calculated using worst-case tolerancing, and typical backlash is calculated using statistical tolerancing.

Note 6: Release and response times measured on standalone brakes with Kollmorgen AKD drive. Release/Response Time of the brake measured with a diode and a transistor in power supply circuit.

Note 7: Brake release time, i.e. the time for the brake to release when the power is applied to the brake, is fairly consistent regardless of how the brake is switched.

Note 8: Brake response time, i.e. the time taken for the brake to re-engage when the power is cut if the circuit contains any form of arc suppression over the switching, then the decay circuit within the brake, when the power is cut, will be prolonged.

Note 9: Cutting the brake supply on the 'dc' side, i.e. a clean cut in the brake supply at the brake connection, will give the fastest possible switching.

Note 10: Current of the brake is calculated from nominal voltage and nominal resistance at 25°C

Note 11: Acceleration calculated from maximum acceleration of Kollmorgen AKM2G motor with the brake without external load.

Note 12: Brake is able to perform 50.000.000 reverse cycles with maximum acceleration and backlash up to 0.8°.

Note 13: B_{10d} is number of operations where 10% of the sample would fail to danger.

Note 14: New brake - brake mounted in the motor without previous usage. Parameters could be influenced by number of emergency stops absorbed by brake during lifetime.

Note 15: Response times measured on brakes connected to a Kollmorgen AKD drive. Response time of the brake measured with a diode and a transistor in power supply current.

Note 16: Total time needed to achieve 90% static torque (see graphs below). Vertical load application setup requires using the AKD or alternative drive manufacturers total torque rise time. See the following graphs for the total time needed to achieve 90% of static torque.

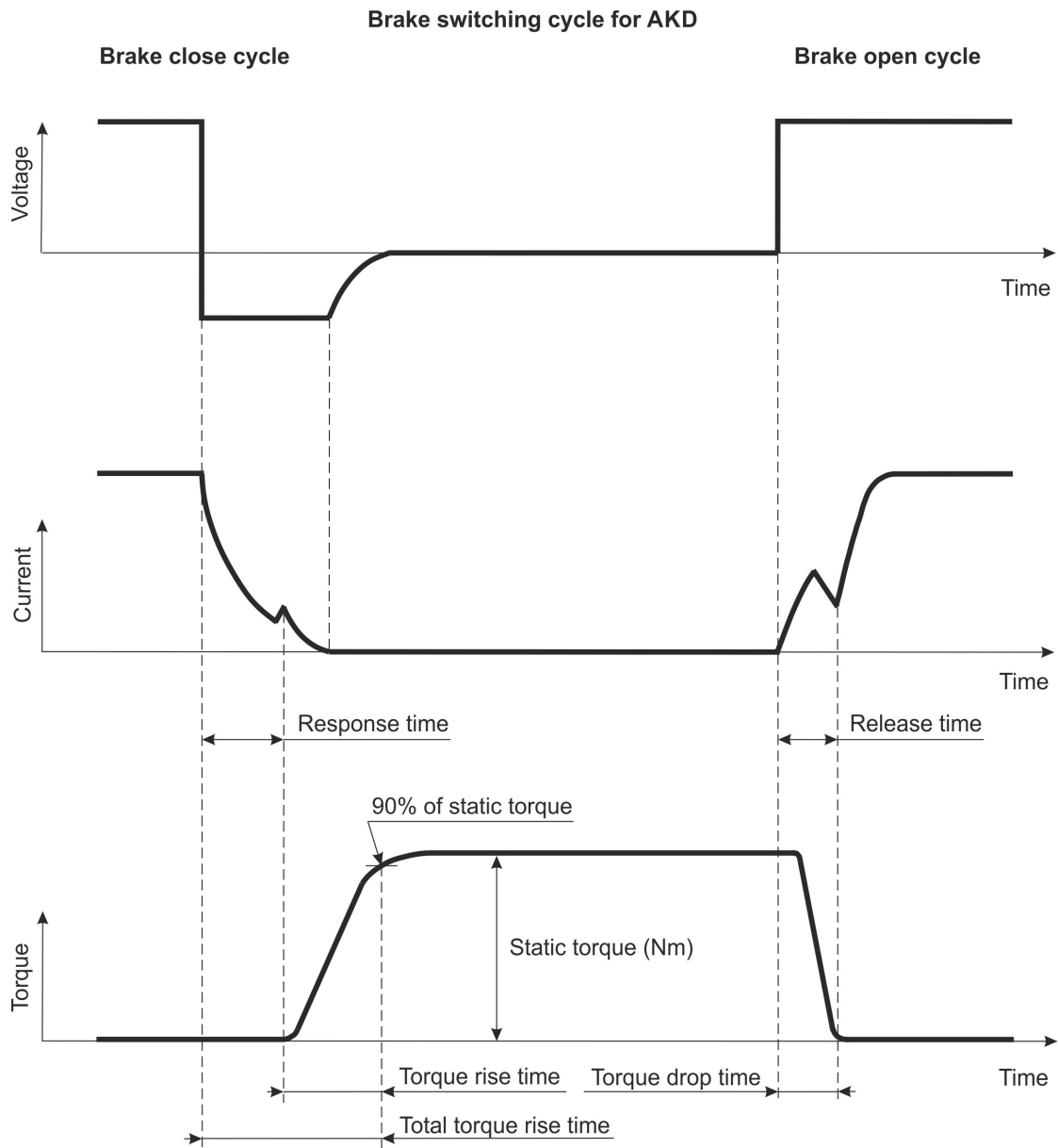

8 Dimension drawings

All drawings in this chapter are drawings in principle (not scaled). 3D Models are available from www.kollmorgen.com.

8.1 Dimensions/Radial Forces AKM2G2 (Ax flanges)	338
8.2 Dimensions/Radial Forces AKM2G3 (Ax flanges)	340
8.3 Dimensions/Radial Forces AKM2G4 (Ax flanges)	342
8.4 Dimensions/Radial Forces AKM2G5 (Ax flanges)	345
8.5 Dimensions/Radial Forces AKM2G6 (Ax flanges)	348
8.6 Dimensions/Radial Forces AKM2G7 (Ax flanges)	351

8.1 Dimensions/Radial Forces AKM2G2 (Ax flanges)

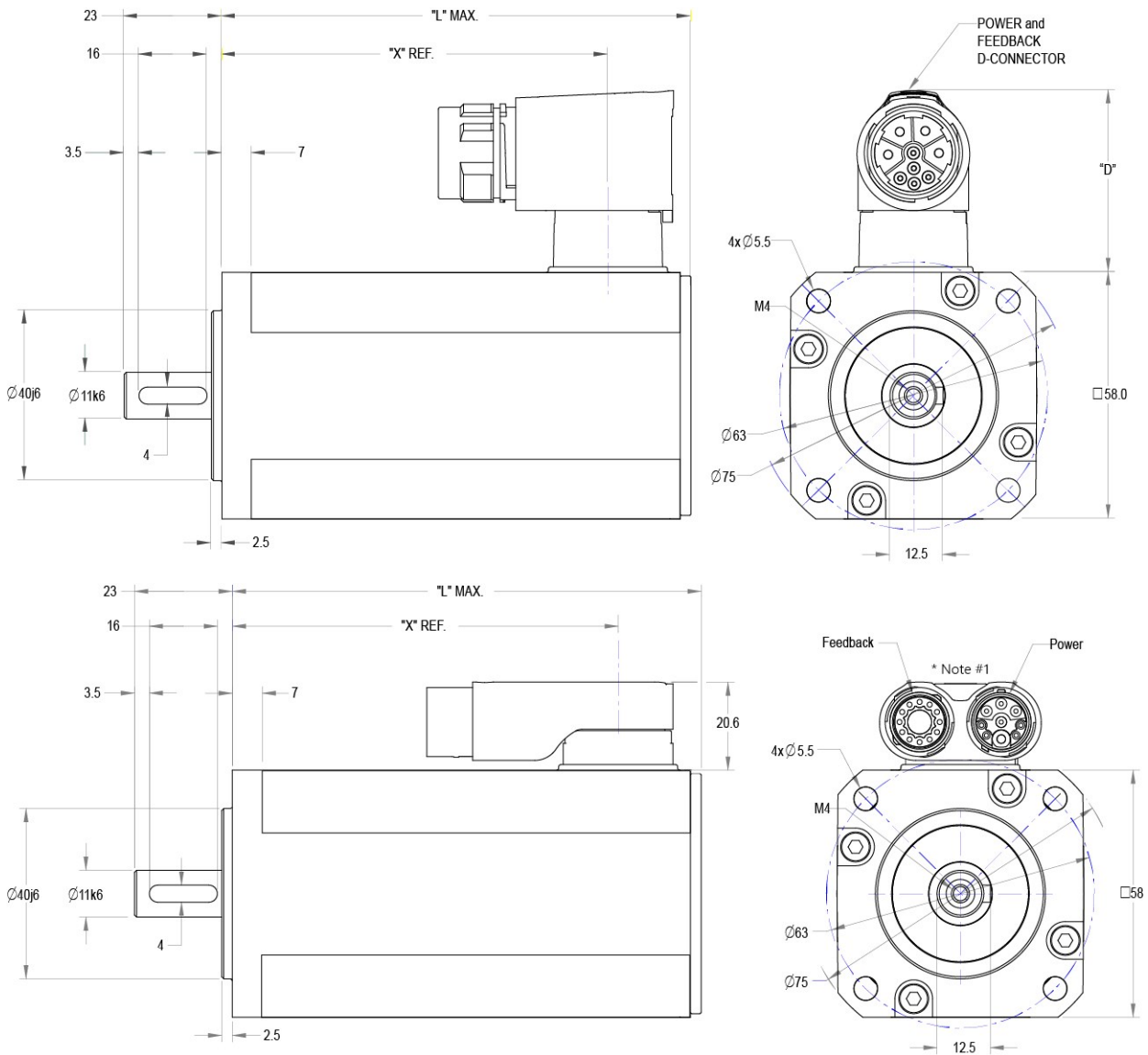

Model	Non-Brake						D-Connector Feedback	
	X Ref		L Max				SFD3 ³	DSL & EnDat
			Resolver / SFD3 ²		DSL / EnDat 2.2			
mm	inch	mm	inch	mm	inch			
AKM2G-21	90.75	3.573	111.15	4.376	118.15	4.652	42.8	44.1
AKM2G-22	110.00	4.331	130.40	5.134	137.40	5.409		
AKM2G-23	129.25	5.089	149.65	5.892	156.65	6.167		
AKM2G-24	148.50	5.846	168.90	6.650	175.90	6.925		

Model	Brake						D-Connector Feedback	
	X Ref		L Max				SFD3 ³	DSL & EnDat
	mm	inch	Resolver / SFD3 ²		DSL / EnDat 2.2			
		mm	inch	mm	inch			
AKM2G-21	129.75	5.108	150.15	5.911	157.15	6.187	42.8	44.1
AKM2G-22	149.00	5.866	169.40	6.669	176.40	6.945		
AKM2G-23	168.25	6.624	188.65	7.427	195.65	7.703		
AKM2G-24	187.50	7.382	207.90	8.185	214.90	8.461		

1. The dual connector (ytec) option is not available on Low Voltage motors.
2. Resolver / SFD3 is not offered in this size on Low Voltage motors.
3. SFD3 is not a standard offer in this size on Low Voltage motors.

Radial/axial forces at shaft end

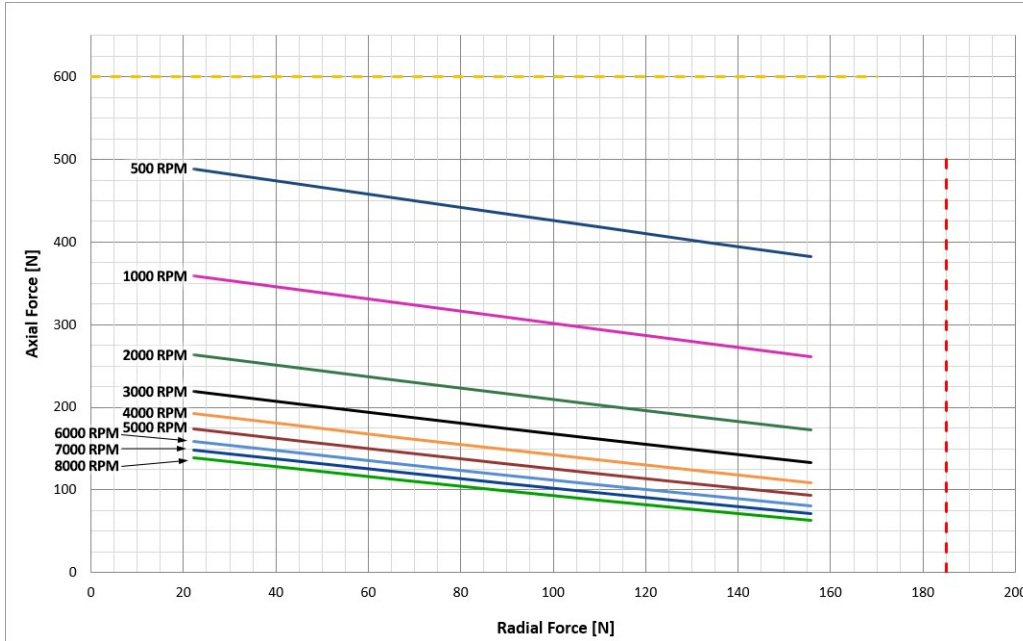

8.2 Dimensions/Radial Forces AKM2G3 (Ax flanges)

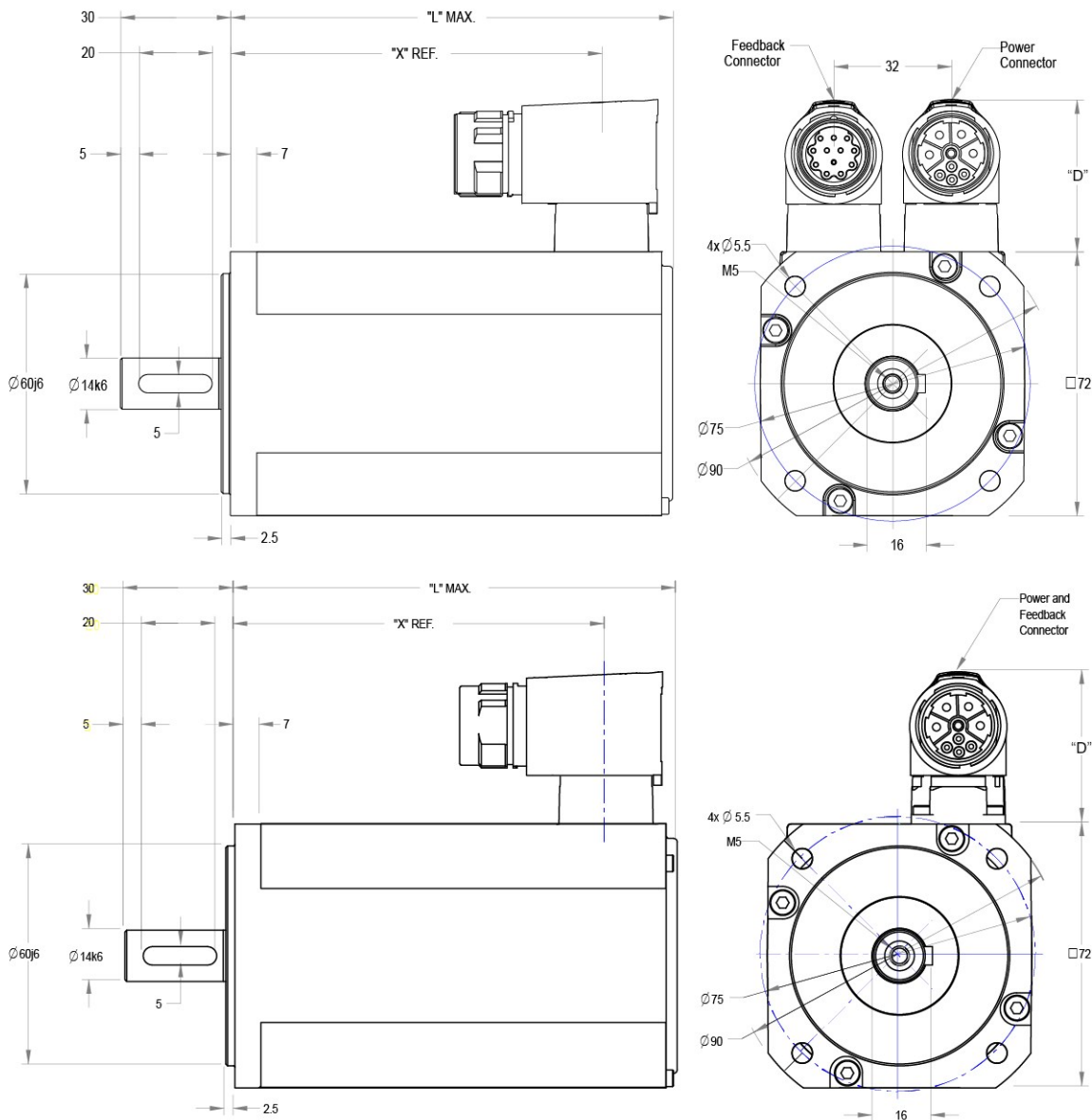

Model	Non-Brake								D - Connector Feedback	
	X Ref		L Max						SFD3 ³	DSL & EnDat
			Resolver / SFD3 ¹		Commutating Encoder ²		DSL / EnDat 2.2			
mm	inch	mm	inch	mm	inch	mm	inch			
AKM2G-31	101.10	3.980	121.40	4.780			129.40	5.094	41.4	42.8
AKM2G-32	132.25	5.207	152.55	6.006			160.55	6.321		
AKM2G-33	163.40	6.433	183.70	7.232			191.70	7.547		

Model	Brake								D - Connector Feedback	
	X Ref		L Max.						SFD3 ³	DSL & EnDat
			Resolver / SFD3 ¹		Commutating Encoder ²		DSL / EnDat 2.2			
	mm	inch	mm	inch	mm	inch	mm	inch		
AKM2G-31	142.30	5.602	162.60	6.402			170.60	6.717	41.4	42.8
AKM2G-32	173.45	6.829	193.75	7.628			201.75	7.943		
AKM2G-33	204.60	8.055	224.90	8.854			232.90	9.169		

1. SFD3 is not a standard option for Low Voltage motors.
2. Commutating Encoder is only available on Low Voltage motors.
3. SFD3 is not a standard offering in this size.

Radial/axial forces at shaft end

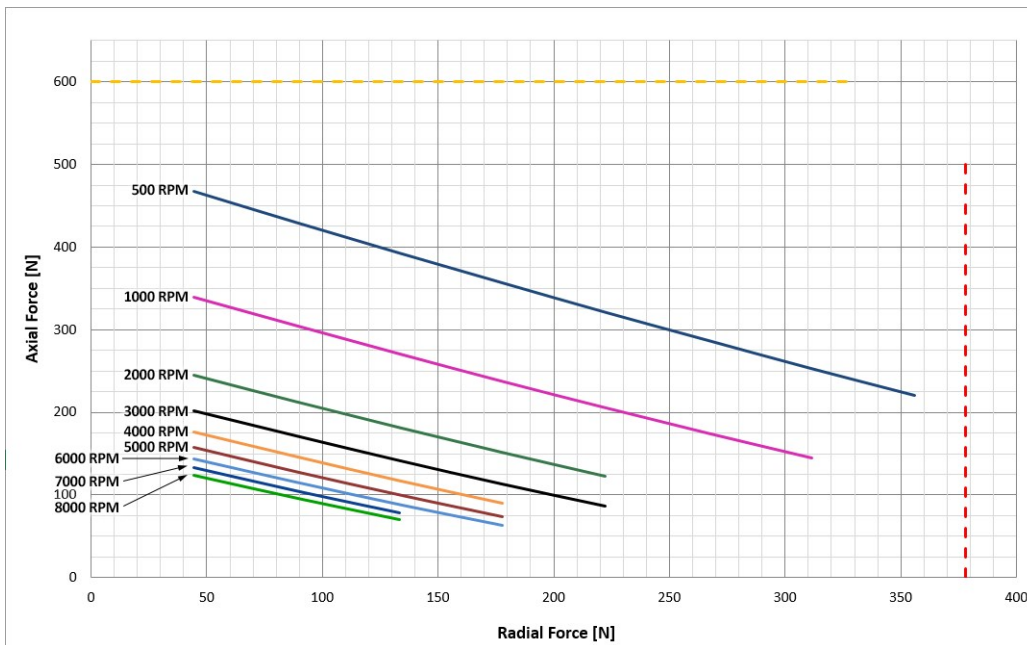

8.3 Dimensions/Radial Forces AKM2G4 (Ax flanges)

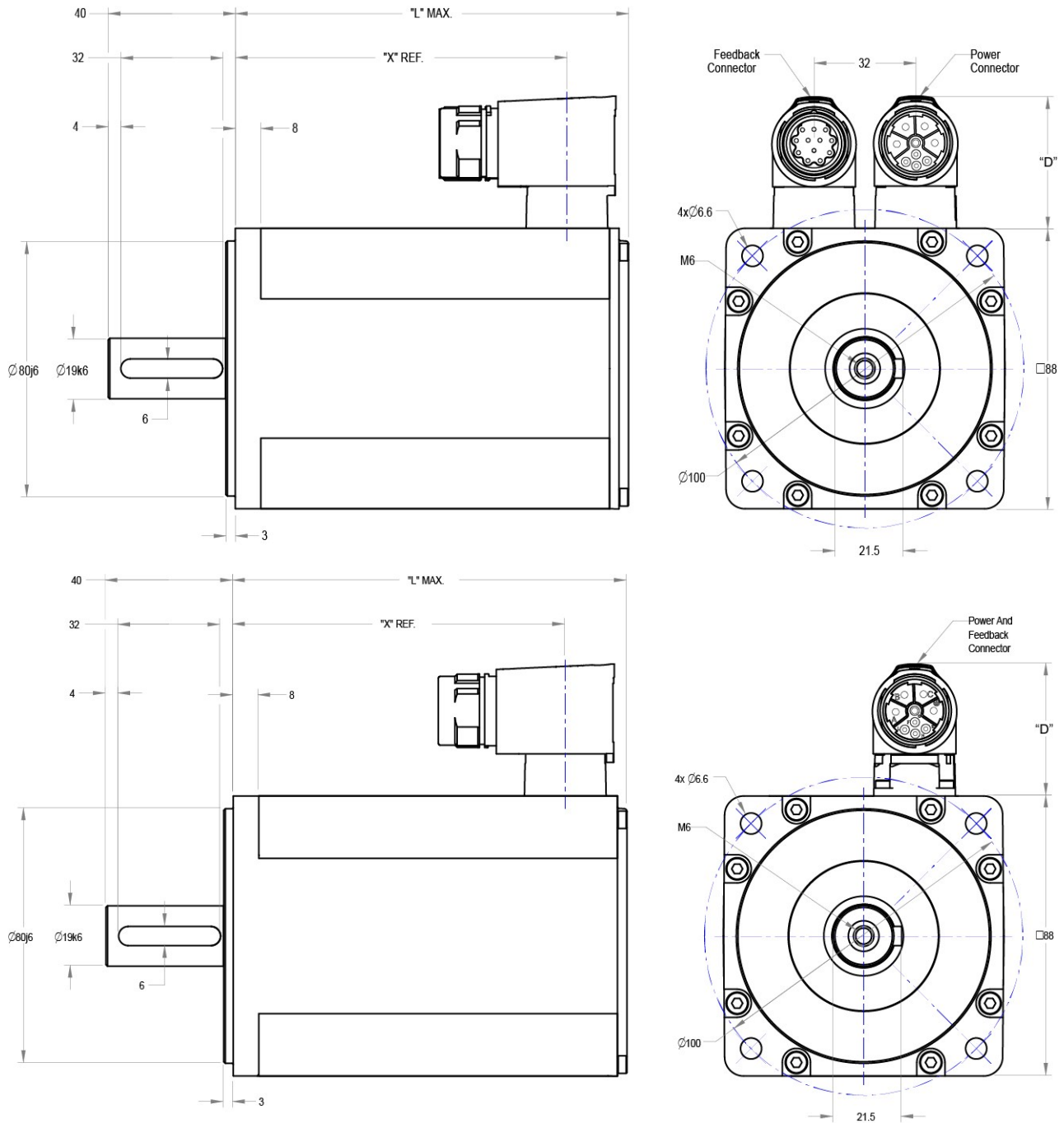

Model	Non-Brake								D - Connector Feedback	
	X Ref		L Max						SFD3 ¹	DSL & EnDat
			Resolver / SFD3 ¹		Commutating Encoder ²		DSL / EnDat 2.2			
	mm	inch	mm	inch	mm	inch	mm	inch		
AKM2G-41	104.30	4.106	124.60	4.906			132.60	5.220	41.4	42.8
AKM2G-42	130.55	5.140	150.85	5.939			158.85	6.254		
AKM2G-43	156.80	6.173	177.10	6.972			185.10	7.287		
AKM2G-44	183.03	7.207	203.35	8.006			211.35	8.321		
Model	Brake								D - Connector Feedback	
	X Ref		L Max.						SFD3 ¹	DSL & EnDat
			Resolver / SFD3 ¹		Commutating Encoder ²		DSL / EnDat 2.2			
	mm	inch	mm	inch	mm	inch	mm	inch		
AKM2G-41	152.10	5.988	172.40	6.787			180.40	7.102	41.4	42.8
AKM2G-42	178.35	7.022	198.65	7.821			206.65	8.136		
AKM2G-43	204.60	8.055	224.90	8.854			232.90	9.169		
AKM2G-44	230.85	9.089	251.15	9.888			259.15	10.203		

1. SFD3 is not a standard option for Low Voltage motors.
2. Commutating Encoder is only available on Low Voltage motors.
3. SFD3 is not a standard offering in this size.

Radial/axial forces at shaft end

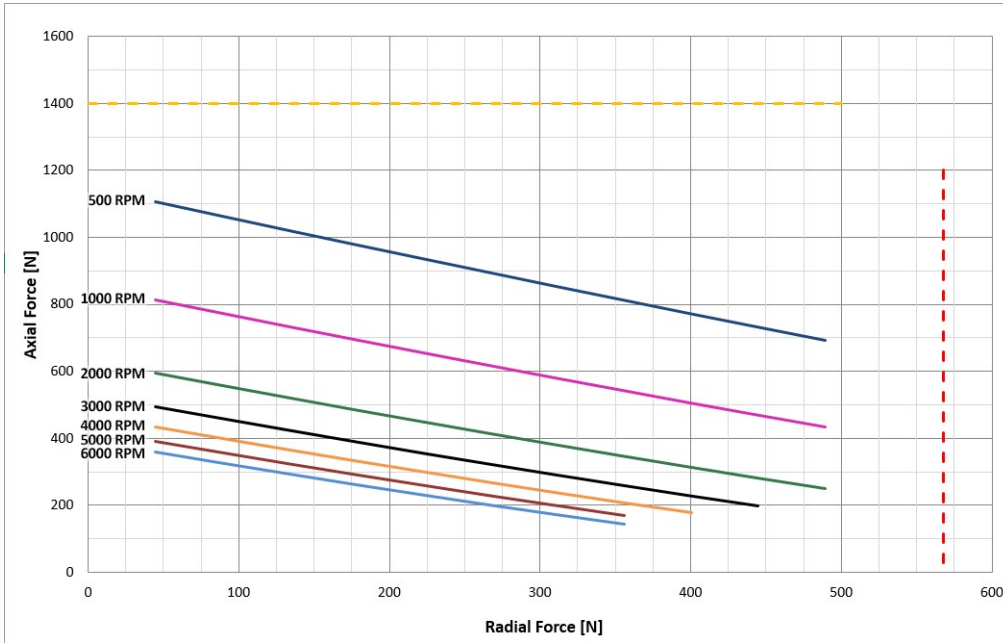

8.4 Dimensions/Radial Forces AKM2G5 (Ax flanges)

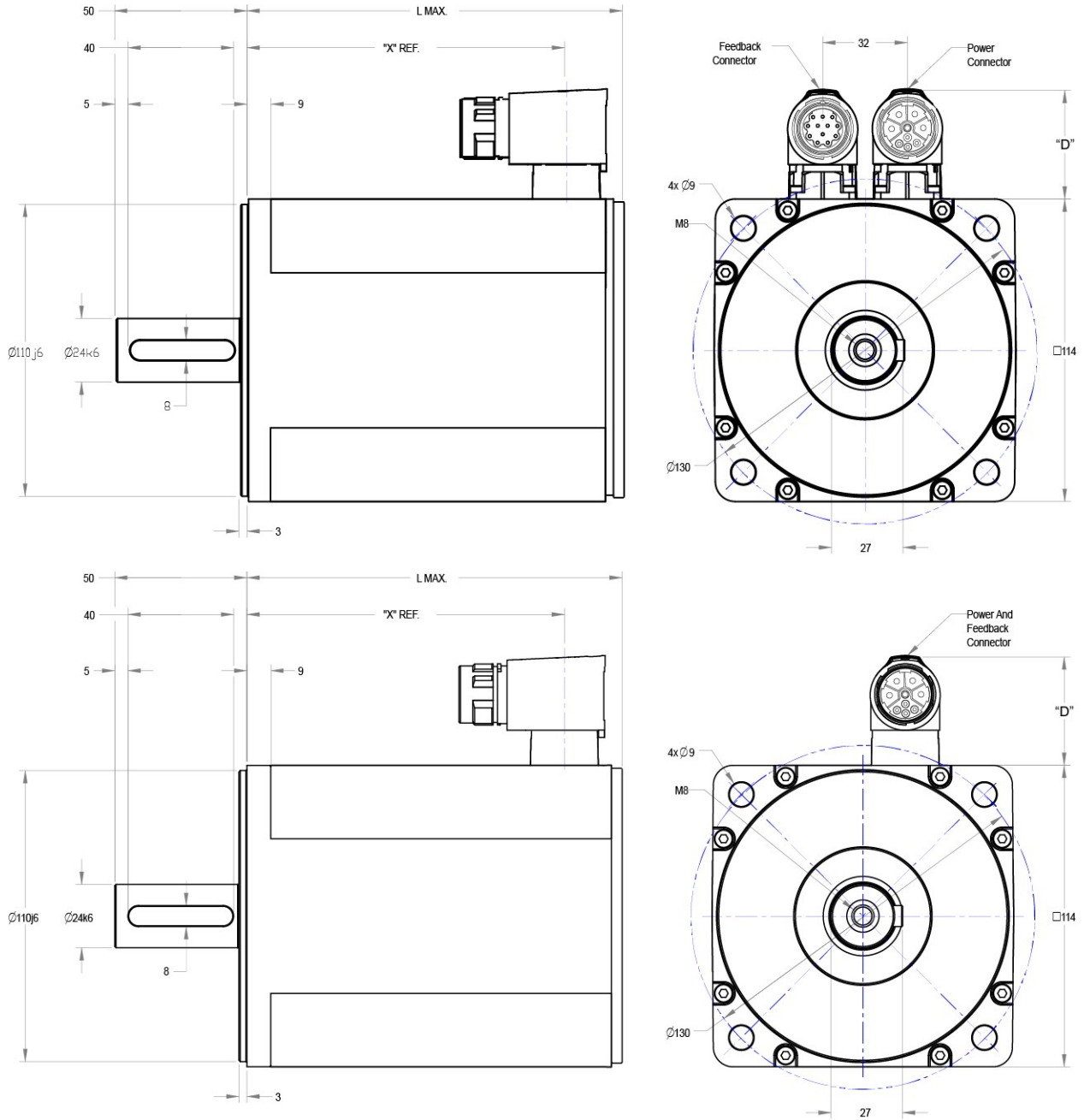

Model	Non-Brake						D - Connector Feedback	
	X Ref		L Max				SFD3	DSL & EnDat
			Resolver / SFD3		DSL / EnDat 2.2			
	mm	inch	mm	inch	mm	inch		
AKM2G-51	120.10	4.728	142.80	5.622	148.40	5.843		
AKM2G-52	149.50	5.886	172.20	6.780	177.80	7.000		
AKM2G-53	178.90	7.043	201.60	7.937	207.20	8.157		
AKM2G-54	208.30	8.201	231.00	9.094	236.60	9.315		

Model	Brake						D - Connector Feedback	
	X Ref		L Max.				SFD3	DSL & EnDat
			Resolver / SFD3		DSL / EnDat 2.2			
	mm	inch	mm	inch	mm	inch		
AKM2G-51	177.10	6.972	199.80	7.866	205.40	8.087		
AKM2G-52	206.50	8.130	229.20	9.024	234.80	9.244		
AKM2G-53	234.90	9.287	258.60	10.181	264.20	10.402		
AKM2G-54	265.30	10.445	288.00	11.339	293.60	11.559		

Radial/axial forces at shaft end

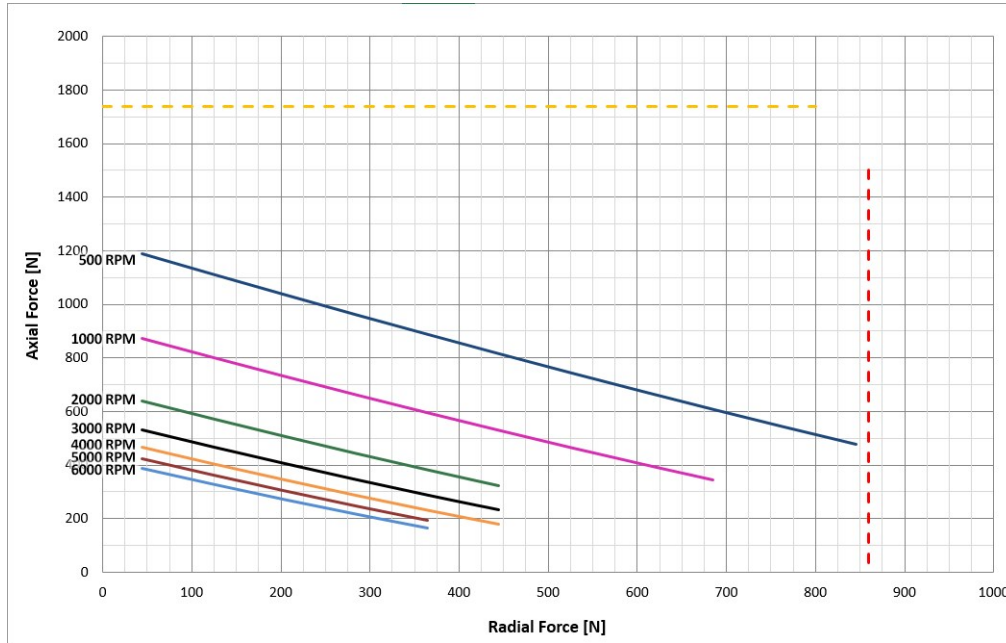

8.5 Dimensions/Radial Forces AKM2G6 (Ax flanges)

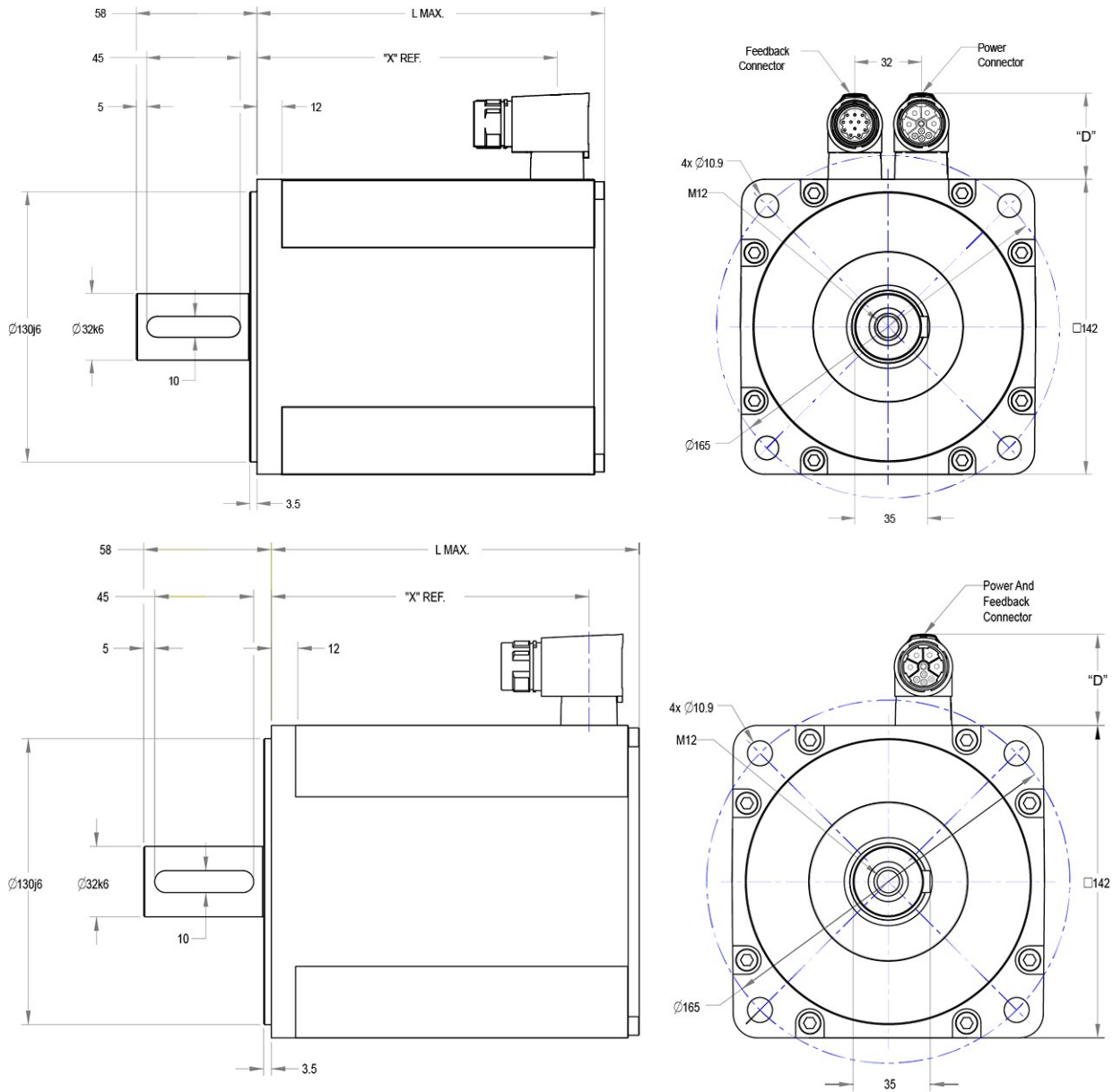

Model	Non-Brake						D - Connector Feedback	
	X Ref		L Max				SFD3	DSL & EnDat
			Resolver / SFD3		DSL / EnDat 2.2			
	mm	inch	mm	inch	mm	inch		
AKM2G-62	144.40	5.685	168.10	6.618	178.40	7.024	41.4	42.8
AKM2G-63	166.45	6.553	190.15	7.486	200.45	7.892		
AKM2G-64	188.50	7.421	212.20	8.354	222.50	8.760		
AKM2G-65	210.55	8.289	234.25	9.222	244.55	9.628		

Model	Brake						D - Connector Feedback	
	X Ref		L Max.				SFD3	DSL & EnDat
			Resolver / SFD3		DSL / EnDat 2.2			
	mm	inch	mm	inch	mm	inch		
AKM2G-62	210.10	8.272	233.80	9.205	244.10	9.610	41.4	42.8
AKM2G-63	232.15	9.140	255.85	10.073	266.15	10.478		
AKM2G-64	254.20	10.008	277.90	10.941	288.20	11.346		
AKM2G-65	276.25	10.876	299.95	11.809	310.25	12.215		

Radial/axial forces at shaft end

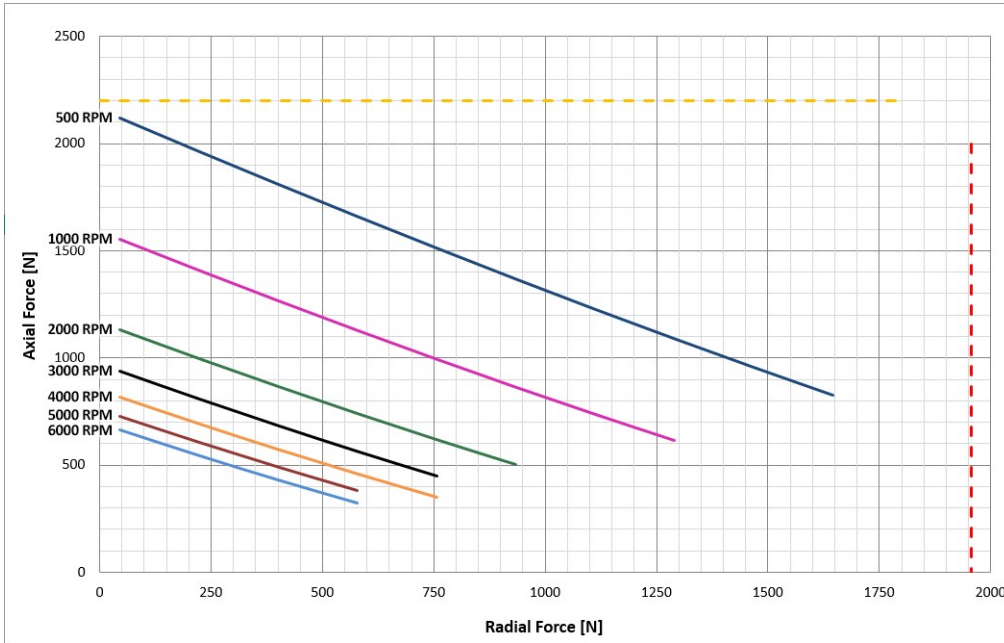

8.6 Dimensions/Radial Forces AKM2G7 (Ax flanges)

Dimensions of AKM2G7ACCNR

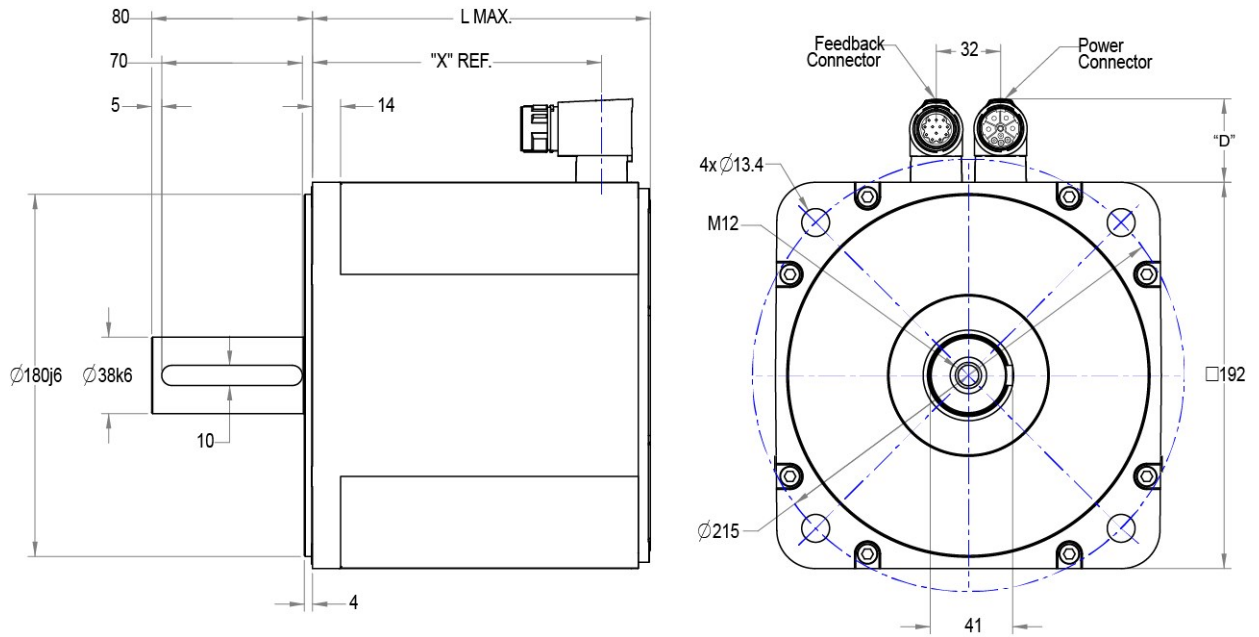

Dimensions of AKM2G7ACDNC

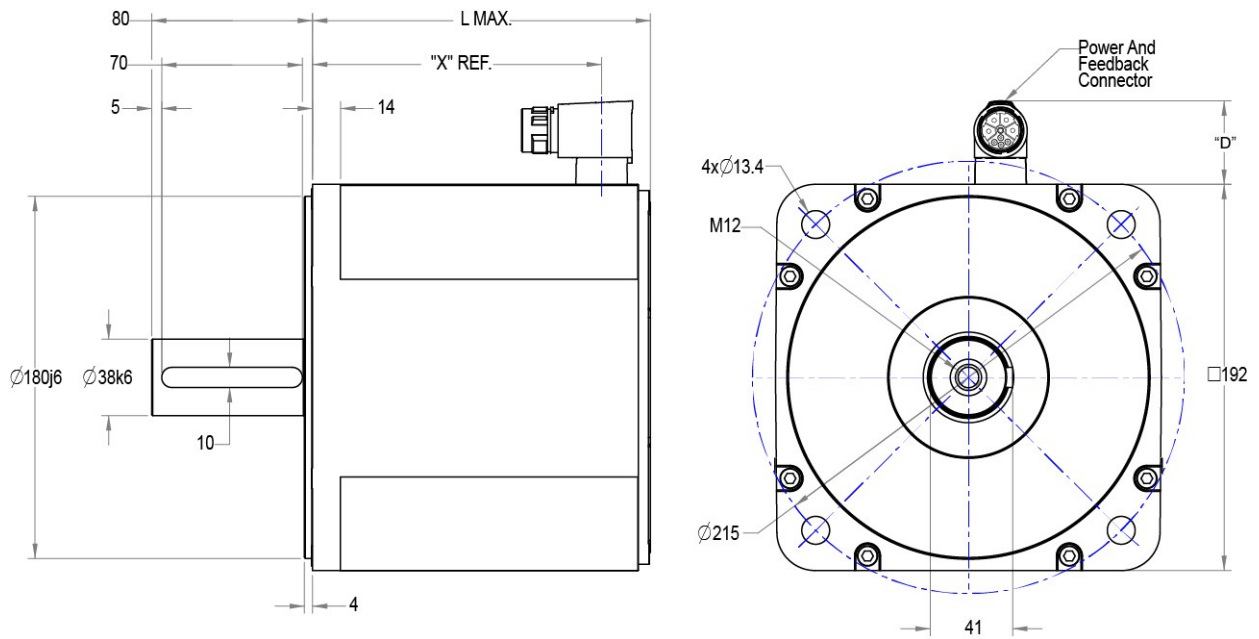

Model	Non-Brake						D-Connector Feedback	
	X Ref		L Max				SFD3	DSL & EnDat
			Resolver / SFD3		DSL / EnDat 2.2			
mm	inch	mm	inch	mm	inch			
AKM2G-71	143.90	5.665	169.10	6.657	181.10	7.130	41.4	42.8
AKM2G-72	177.85	7.002	203.05	7.994	215.05	8.467		
AKM2G-73	211.80	8.339	237.00	9.331	249.00	9.803		
AKM2G-74	245.75	9.675	270.95	10.667	282.95	11.140		
Model	Brake						D-Connector Feedback	
	X Ref		L Max.				SFD3	DSL & EnDat
			Resolver / SFD3		DSL / EnDat 2.2			
mm	inch	mm	inch	mm	inch			
AKM2G-71	221.35	8.715	246.55	9.707	258.55	10.179	41.4	42.8
AKM2G-72	255.30	10.051	280.50	11.043	292.50	11.516		
AKM2G-73	289.25	11.388	314.45	12.380	326.45	12.852		
AKM2G-74	323.20	12.724	348.40	13.717	360.40	14.189		

Dimensions of AKM2G7ACHNR

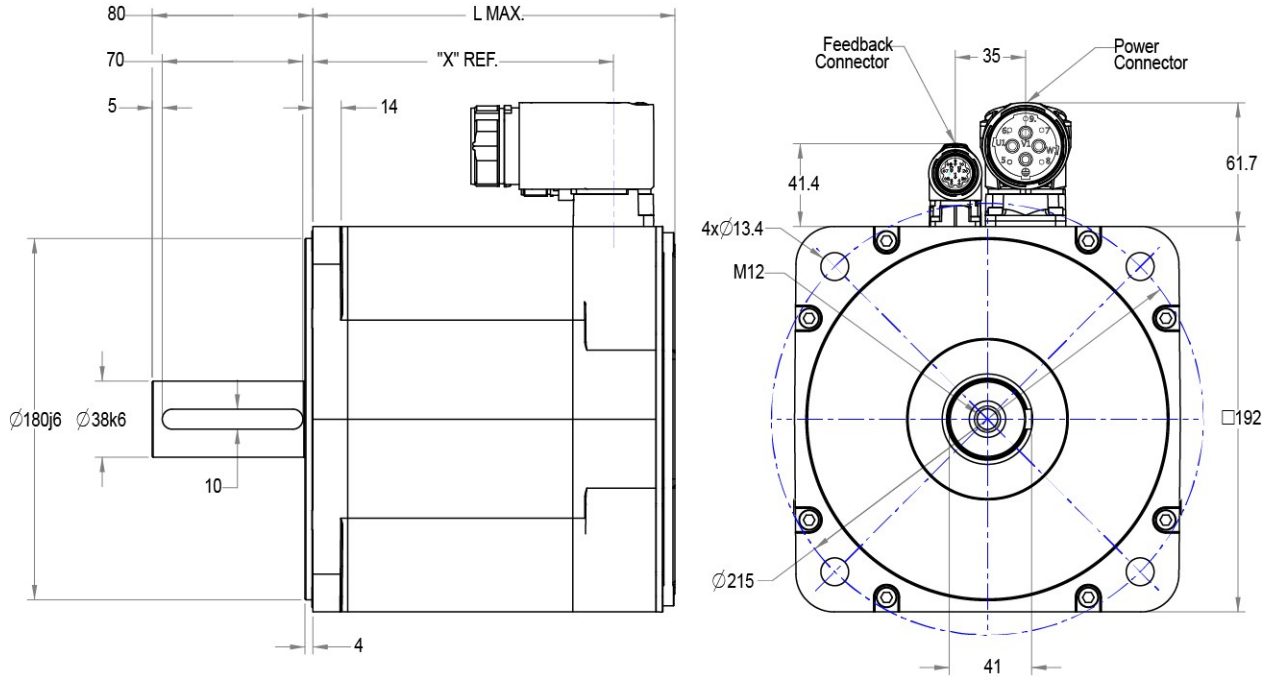

Dimensions of AKM2G7ACJNC

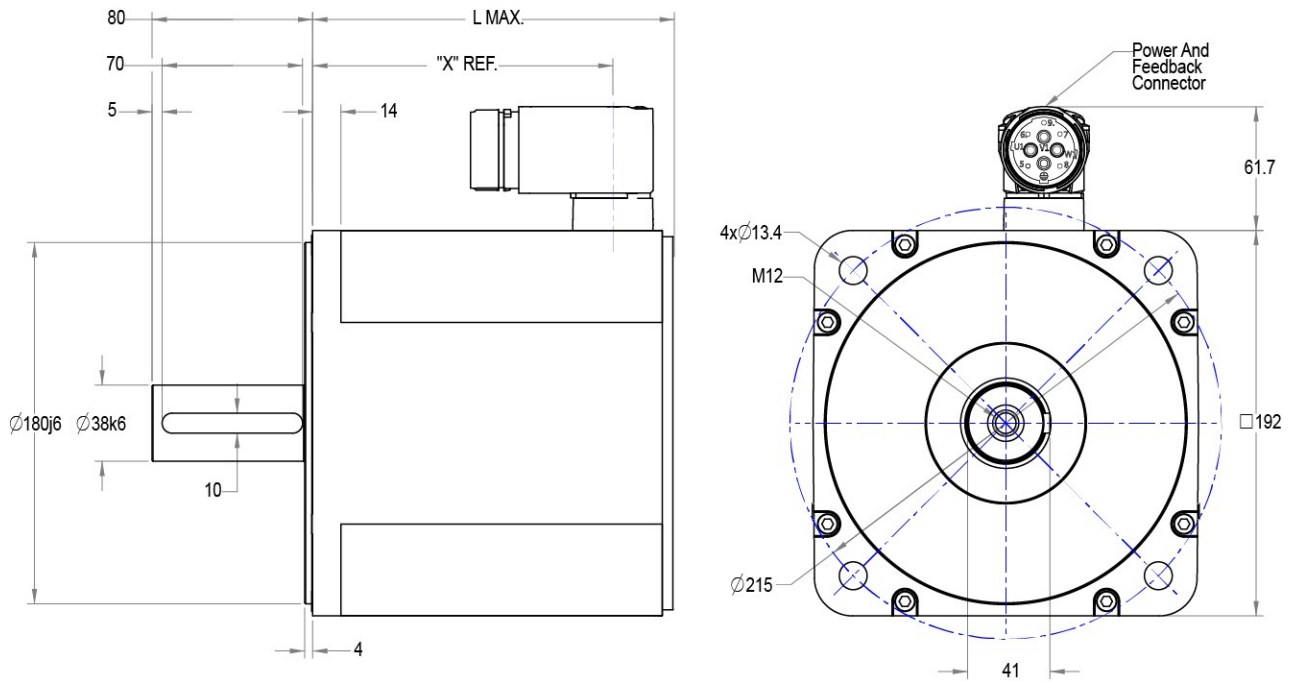

Model	Non-Brake				Brake			
	X Ref.		L Max.		X Ref.		L Max.	
	mm	inch	mm	inch	mm	inch	mm	inch
AKM2G-71	149.60	5.890	181.10	7.130	227.05	8.939	258.55	10.179
AKM2G-72	183.55	7.226	215.05	8.467	261.00	10.276	292.50	11.516
AKM2G-73	217.50	8.563	249.00	9.803	294.95	11.612	326.45	12.852
AKM2G-74	251.45	9.900	282.95	11.140	328.90	12.949	360.40	14.189

Radial/axial forces at shaft end

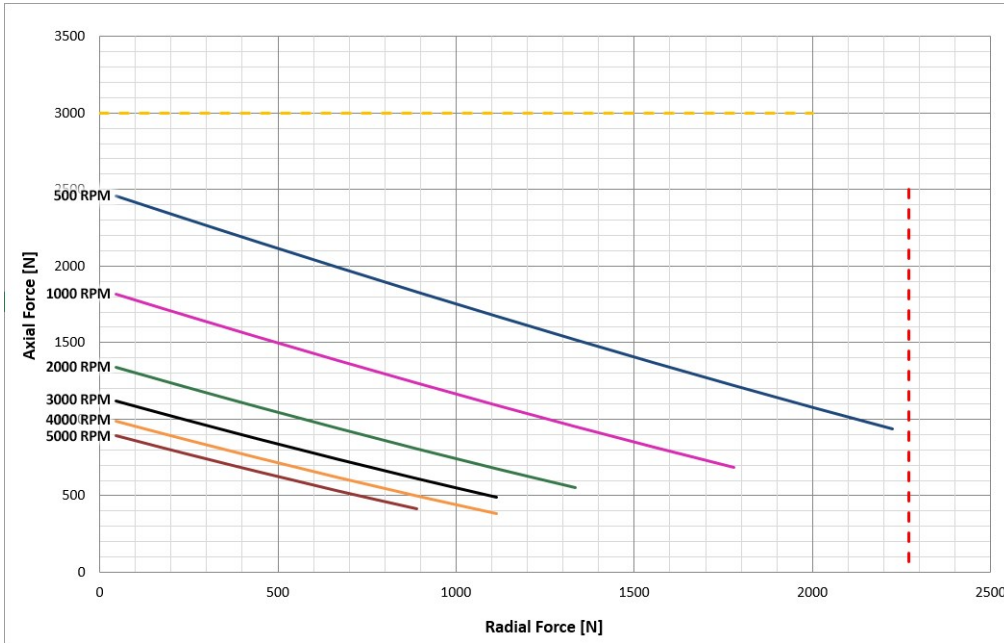

9 Connector Pinout



All connector views: facing front. Abbreviations used :

U	Motor phase U	BR	Motor holding brake	Up	Sensor Voltage supply
V	Motor phase V	TH	Thermal sensor	0V	Ground for Sensor Voltage supply
W	Motor phase W	Z	Zero pulse		
PE	Protection Earth	n.c.	not connected		

9.1 Connector codes Y: AKM2G2	356
9.1.1 Power	356
9.1.2 Resolver (Feedback code R-)	356
9.2 Connector codes C, G, H: AKM2G3 - AKM2G7	357
9.2.1 Power	357
9.2.2 Resolver (Feedback code R-)	358
9.2.3 Commutating Encoder (Feedback code 2-)	358
9.3 Connector code D: AKM2G2 - AKM2G7	359
9.3.1 Power & SFD3 AKM2G2 - AKM2G7 (Feedback codes CA)	359
9.3.2 Power & DSL AKM2G2 - AKM2G7 (Feedback codes GU)	359
9.3.3 Power & EnDat 2.2 Feedback AKM2G2 - AKM2G7 (Feedback codes LD)	359
9.4 Connector code J: AKM2G7	360
9.4.1 Power & SFD3 AKM2G7 (Feedback code CA)	360
9.4.2 Power & DSL AKM2G7 (Feedback code GU)	360

9.1 Connector codes Y: AKM2G2

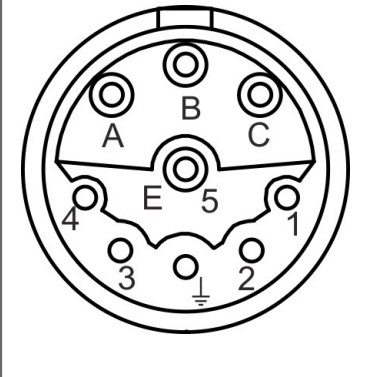
9.1.1 Power

			
Pin	Function	Pin	Function
1	BR +	A	U
2	BR -	B	W
3	N/C	C	V
4	N/C	E	N/C
5	N/C		PE

9.1.2 Resolver (Feedback code R-)

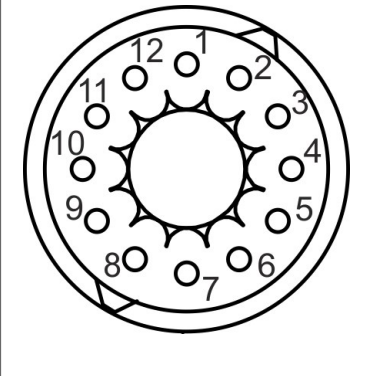
			
Pin	Function	Pin	Function
1	N/C	7	S2, cos+
2	TH +	8	S1, sin+
3	S4, cos-	9	R1, ref+
4	S3, sin-	10	N/C
5	R2, ref-	11	N/C
6	TH -	12	N/C

Note: Resolver Feedback is not offered on Low Voltage motors.

9.2 Connector codes C, G, H: AKM2G3 - AKM2G7

9.2.1 Power

Connector codes C, G for AKM2G3 - AKM2G7

	Pin	Function	Pin	Function
	A	U	F	BR +
		PE	G	BR -
			E	N/C
	C	W	H	N/C
	B	V	L	N/C

Connector code H for AKM2G7

	Pin	Function	Pin	Function
	U	U	5	BR +
	V	V	8	BR -
	W	W	6	N/C
		PE	7	N/C
			9	N/C

9.2.2 Resolver (Feedback code R-)

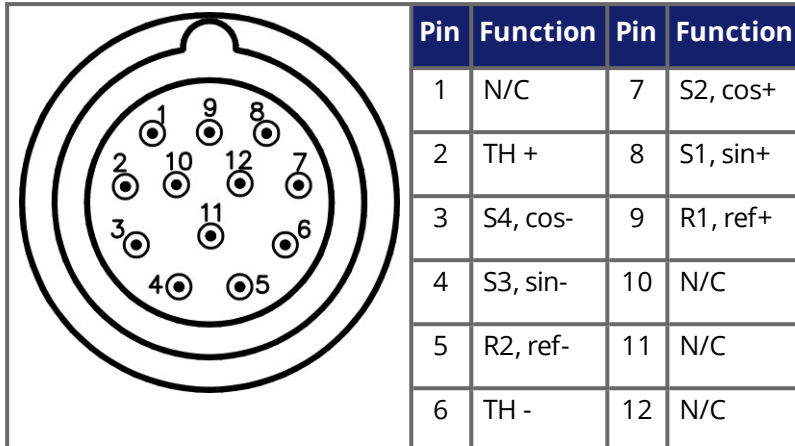

Note: Resolver Feedback is not offered on Low Voltage motors.

9.2.3 Commutating Encoder (Feedback code 2-)

Note: Commutating Encoder is only available on Low Voltage motors for AKM2G3 - AKM2G4.

9.3 Connector code D: AKM2G2 - AKM2G7

9.3.1 Power & SFD3 AKM2G2 - AKM2G7 (Feedback codes CA)

	Pin	Function	Pin	Function
	A	U	F	BR+
		PE	G	BR-
			L	SFD-
	C	W	H	SFD+
	B	V	E	N/C

9.3.2 Power & DSL AKM2G2 - AKM2G7 (Feedback codes GU)

	Pin	Function	Pin	Function
	A	U	C	W
	B	V	D	N/C
	H	DSL+	L	DSL-
		PE	7	BR-
			8	BR+

9.3.3 Power & EnDat 2.2 Feedback AKM2G2 - AKM2G7 (Feedback codes LD)

	Pin	Function	Pin	Function
	A	U	C	W
	B	V	D	N/C
		PE	7	BR-
			8	BR+
	1	Up	2	0V
	3	Data	4	Data
	5	Clock	6	Clock

9.4 Connector code J: AKM2G7

9.4.1 Power & SFD3 AKM2G7 (Feedback code CA)

Pin	Function	Pin	Function
U	U	5	BR+
V	V	8	BR-
W	W	6	SFD+
⏏ PE		7	SFD-
		9	N/C

9.4.2 Power & DSL AKM2G7 (Feedback code GU)

Pin	Function	Pin	Function
U	U	V	V
W	W	N	-
1	BR+	2	BR-
⏏ PE		E1	DSL+
		E2	DSL-

10 Approvals

Certificates can be found on KDN (the Kollmorgen Developer Network) on the [Approvals](#) page.

10.1	Conformance with uL	362
10.2	Conformance with CE	362
10.3	Conformance with EAC	362
10.4	Conformance with RoHS	362
10.5	Conformance with REACH	362

10.1 Conformance with uL

Recognized for USA and Canada in **File E61960**.

10.2 Conformance with CE

The motors have been tested by an authorized testing laboratory in a defined configuration. Any divergence from the configuration and installation described in this documentation means that the user will be responsible for carrying out new measurements to ensure conformance with regulatory requirements.

NOTICE

Feedback systems and contacts must not be tested with high voltage. Feedback systems are not suitable for high voltage testing, it is allowed to exclude sensitive electronic components from these tests. Feedback systems might be destroyed during a high voltage test.

NOTE

CE Declaration of Conformity can be found on the Kollmorgen website.

Kollmorgen declares the conformity of the product series AKM2G with the following directives:

- **EC Directive 2014/35/EU, Low voltage**
- **EC Directive 2014/30/EU, Electromagnetic compatibility**

10.3 Conformance with EAC

EAC is the abbreviation for EurAsian Conformity. The mark is used in the states of the Eurasian Customs Union (Russia, Belarus, Kazakhstan) similar to the European CE mark.

Kollmorgen declares, that the AKM2G has passed all required conformity procedures in a member state of the Eurasian Customs Union, and that the AKM2G meets all technical requirements requested in the member states of the Eurasian Customs Union :

- Low voltage (TP TC 020/2011)
- Electromagnetic Compatibility (TP TC 004/2011)

Contact in Russia:

Intelligence Automatics LLC. , Bakuninskaya Str. d 14, Building 1, RU-105005 Moskau

10.4 Conformance with RoHS

Directive 2011/65/EC of the European Union on the restriction of the use of certain hazardous substances in electrical and electronic equipment (RoHS) became operative as from the 3rd of January, 2013. Following substances namely are involved

Lead (Pb), Cadmium (Cd), Hexavalent chromium (CrVI), Polybrominated biphenyls (PBB), Polybrominated diphenyl ethers (PBDE), Mercury (Hg)

The AKM2G motor series is manufactured RoHS conformal.

10.5 Conformance with REACH

EU Regulation no. 1907/2006 deals with the registration, evaluation, authorisation and restriction of chemical substances 1 (abbreviated to "REACH").

AKM2G motors do not contain any substances (CMR substances, PBTsubstances, vPvB substances and similar hazardous substances stipulated in individual cases based on scientific criteria) above 0.1 mass percent per product that are included on the candidate list.

About KOLLMORGEN

Kollmorgen is a leading provider of motion systems and components for machine builders. Through world-class knowledge in motion, industry-leading quality and deep expertise in linking and integrating standard and custom products, Kollmorgen delivers breakthrough solutions that are unmatched in performance, reliability and ease-of-use, giving machine builders an irrefutable marketplace advantage.



Join the [Kollmorgen Developer Network](#) for product support. Ask the community questions, search the knowledge base for answers, get downloads, and suggest improvements.

North America

KOLLMORGEN

201 West Rock Road
Radford, VA 24141, USA

Web: www.kollmorgen.com

Mail: support@kollmorgen.com

Tel.: +1 - 540 - 633 - 3545

Fax: +1 - 540 - 639 - 4162

Europa

KOLLMORGEN Europe GmbH

Pempelfurtstr. 1
40880 Ratingen, Germany

Web: www.kollmorgen.com

Mail: technik@kollmorgen.com

Tel.: +49 - 2102 - 9394 - 0

Fax: +49 - 2102 - 9394 - 3155

South America

KOLLMORGEN

Avenida João Paulo Ablas, 2970
Jardim da Glória, Cotia – SP
CEP 06711-250, Brazil

Web: www.kollmorgen.com

Mail: contato@kollmorgen.com

Tel.: +55 11 4615-6300

China and SEA

KOLLMORGEN Asia

Room 302, Building 5, Lihpao Plaza,
88 Shenbin Road, Minhang District,
Shanghai, China

Web: www.kollmorgen.cn

Mail: sales.china@kollmorgen.com

Tel.: +86 - 400 668 2802